



Features

- 2 pole AC inlet IEC320-C8, Class II power unit
- Medical safety approved (2 x MOPP) according to ANSI/AAMI ES60601-1 and IEC/EN60601-1
- Extremely low leakage current
- No load power consumption < 0.15W
- Energy efficiency level VI and meet CoC Version 5
- -30~+70°C wide range working temperature
- Protections: Short circuit / Overload / Over voltage / Over temperature
- LED indicator for power on
- Lifetime > 105 K hours
- 3 years warranty

Applications

- Mobile clinical workstation
- Oral irrigator
- Portable hemodialysis machine
- Breath Machine
- Medical computer monitor

Description

GSM120B is a highly reliable, 120W desktop style single-output green medical adaptor series. This product is equipped with a 2-pin (no FG) standard IEC320-C8 power plug, adopting the input range from 80VAC to 264VAC. The entire series supplies different output voltages between 12VDC and 48VDC that can satisfy the demands for various kinds of medical electrical devices. The circuitry design meets the international medical standards (2*MOPP), having an ultra low leakage current (<100μA), fitting the medical devices in direct electrical contact with the patients.

With the efficiency up to 91.5% and the extremely low no-load power consumption below 0.15W, GSM120B is compliant with USA EISA 2007/DoE, Canada NRCAN, Australia and New Zealand MEPS, EU ErP, and meet Code of Conduct (CoC) Version 5. The supreme feature allows the adaptor to save the energy when it is either under the operating mode or the standby mode. The entire series utilizes the 94V-0 flame retardant plastic case, providing the double insulation that effectively prevents electrical shock. GSM120B is approved with the international medical safety certificates.

Model Encoding

GSM120B 12 - R7B

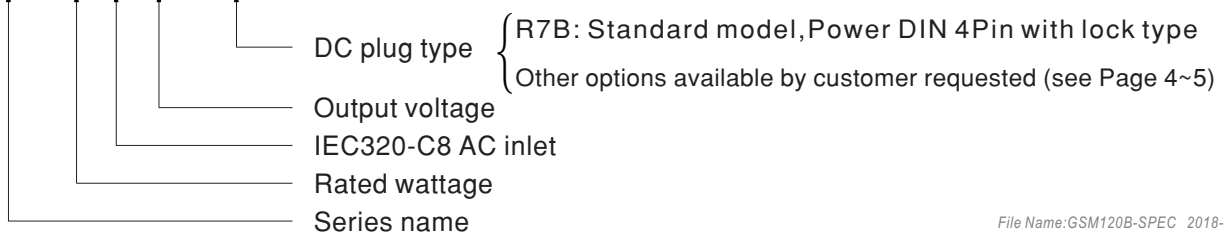

SPECIFICATION

ORDER NO.	GSM120B12-R7B	GSM120B15-R7B	GSM120B20-R7B	GSM120B24-R7B	GSM120B48-R7B	
OUTPUT	SAFETY MODEL NO.	GSM120B12	GSM120B15	GSM120B20	GSM120B24	GSM120B48
	DC VOLTAGE Note.2	12V	15V	20V	24V	48V
	RATED CURRENT	8.5A	7A	6A	5A	2.5A
	CURRENT RANGE	0 ~ 8.5A	0 ~ 7A	0 ~ 6A	0 ~ 5A	0 ~ 2.5A
	RATED POWER (max.)	102W	105W	120W	120W	120W
	RIPPLE & NOISE (max.) Note.3	100mVp-p	120mVp-p	150mVp-p	180mVp-p	200mVp-p
	VOLTAGE TOLERANCE Note.4	± 5.0%	± 5.0%	± 5.0%	± 3.0%	± 2.5%
	LINE REGULATION Note.5	± 1.0%	± 1.0%	± 1.0%	± 1.0%	± 1.0%
	LOAD REGULATION	± 5.0%	± 5.0%	± 4.0%	± 3.0%	± 2.5%
	SETUP, RISE TIME Note.6	1500ms, 30ms / 230VAC 2000ms, 30ms / 115VAC at full load				
HOLD UP TIME (Typ.)	40ms / 230VAC 24ms / 115VAC at full load					
INPUT	VOLTAGE RANGE Note.7	80 ~ 264VAC 113 ~ 370VDC				
	FREQUENCY RANGE	47 ~ 63Hz				
	POWER FACTOR (Typ.)	PF>0.93 / 230VAC PF>0.97 / 115VAC at full load				
	EFFICIENCY (Typ.)	88%	89%	89.5%	90%	91.5%
	AC CURRENT (Typ.)	1.4A / 115VAC 0.7A / 230VAC				
	INRUSH CURRENT (Typ.)	Cold start 35A / 115VAC 70A / 230VAC				
	LEAKAGE CURRENT(max.)	Touch current < 100 μ A/264VAC				
PROTECTION	OVERLOAD	105 ~ 160% rated output power Protection type : Hiccup mode, recovers automatically after fault condition is removed				
	OVER VOLTAGE	105 ~ 135% rated output voltage Protection type : Shut down o/p voltage, re-power on to recover				
	OVER TEMPERATURE	Shut down o/p voltage, re-power on to recover				
ENVIRONMENT	WORKING TEMP.	-30 ~ +70 $^{\circ}$ C (Refer to "Derating Curve")				
	WORKING HUMIDITY	20% ~ 90% RH non-condensing				
	STORAGE TEMP., HUMIDITY	-40 ~ +85 $^{\circ}$ C, 10 ~ 95% RH non-condensing				
	TEMP. COEFFICIENT	± 0.03% / $^{\circ}$ C (0 ~ 40 $^{\circ}$ C)				
	VIBRATION	10 ~ 500Hz, 2G 10min./1cycle, period for 60min. each along X, Y, Z axes				
	OPERATING ALTITUDE Note.8	3000 meters				
SAFETY & EMC (Note. 9)	SAFETY STANDARDS	IEC60601-1, EN60601-1/ EN60601-1-11, ANSI/AAMI ES60601-1 / ES60601-1-11(3.1 version), CAN/CSA-C22.2 No. 60601-1:14 - Edition 3, EAC TP TC 004 approved				
	ISOLATION LEVEL	Primary-Secondary: 2xMOPP				
	WITHSTAND VOLTAGE	I/P-O/P: 4KVAC				
	ISOLATION RESISTANCE	I/P-O/P: 100M Ohms / 500VDC / 25 $^{\circ}$ C / 70% RH				
	EMC EMISSION	Parameter	Standard			Test Level / Note
		Conducted emission	EN55011 (CISPR11), FCC PART 15 / CISPR22, CAN ICES-3(B)/NMB-3(B)			Class B
		Radiated emission	EN55011 (CISPR11), FCC PART 15 / CISPR22, CAN ICES-3(B)/NMB-3(B)			Class B
		Harmonic current	EN61000-3-2			Class A
	Voltage flicker	EN61000-3-3			-----	
	EMC IMMUNITY	EN55024 , EN60601-1-2, EN61204-3				
		Parameter	Standard			Test Level / Note
		ESD	EN61000-4-2			Level 4, 15KV air ; Level 4, 8KV contact
		RF field susceptibility	EN61000-4-3			Level 3, 10V/m(80MHz~2.7GHz) Table 9, 9~28V/m(385MHz~5.78GHz)
		EFT bursts	EN61000-4-4			Level 3, 2KV
		Surge susceptibility	EN61000-4-5			Level 3, 1KV/Line-Line
Conducted susceptibility		EN61000-4-6			Level 3, 10V	
Magnetic field immunity		EN61000-4-8			Level 4, 30A/m	
Voltage dip, interruption	EN61000-4-11			100% dip 1 periods, 30% dip 25 periods, 100% interruptions 250 periods		
OTHERS	MTBF	372K hrs min. MIL-HDBK-217F(25 $^{\circ}$ C)				
	DIMENSION	167*67*35mm (L*W*H)				
	PACKING	0.6Kg; 20pcs/13,0Kg/0.9CUFT				
CONNECTOR	PLUG	See page 4~5; Other type available by customer requested				
	CABLE	See page 4~5; Other type available by customer requested				
NOTE	<p>1. All parameters are specified at 230VAC input, rated load, 25$^{\circ}$C 70% RH ambient.</p> <p>2. DC voltage: The output voltage set at point measure by plug terminal & 50% load.</p> <p>3. Ripple & noise are measured at 20MHz by using a 12" twisted pair terminated with a 0.1μf & 47μf capacitor.</p> <p>4. Tolerance: includes set up tolerance, line regulation, load regulation.</p> <p>5. Line regulation is measured from low line to high line at rated load.</p> <p>6. Length of set up time is measured at first cold start. Turning ON/OFF the power supply may lead to increase of the set up time.</p> <p>7. Derating may be needed under low input voltage. Please check the derating curve for more details.</p> <p>8. The ambient temperature derating of 3.5$^{\circ}$C/1000m with fanless models and of 5$^{\circ}$C/1000m with fan models for operating altitude higher than 2000m(6500ft).</p> <p>9. The power supply is considered as an independent unit, but the final equipment still need to re-confirm that the whole system complies with the EMC directives. For guidance on how to perform these EMC tests, please refer to "EMI testing of component power supplies." (as available on http://www.meanwell.com)</p>					

■ Derating Curve

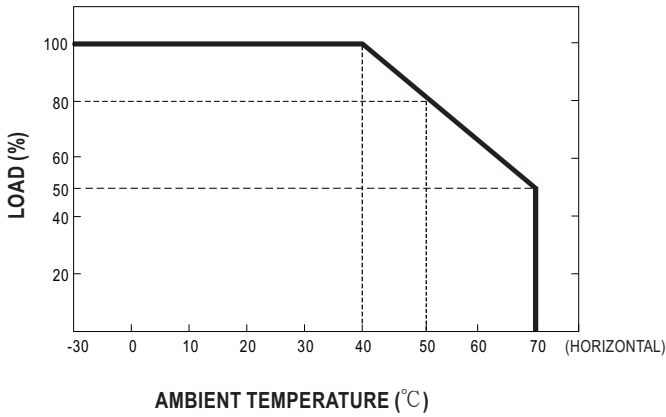

■ Static Characteristics

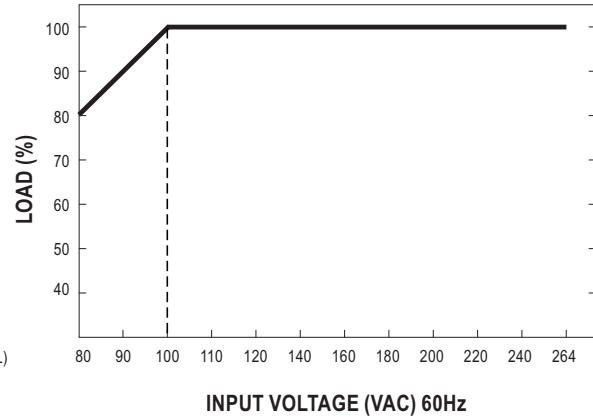

■ Mechanical Specification

Case No. GS120A Unit:mm

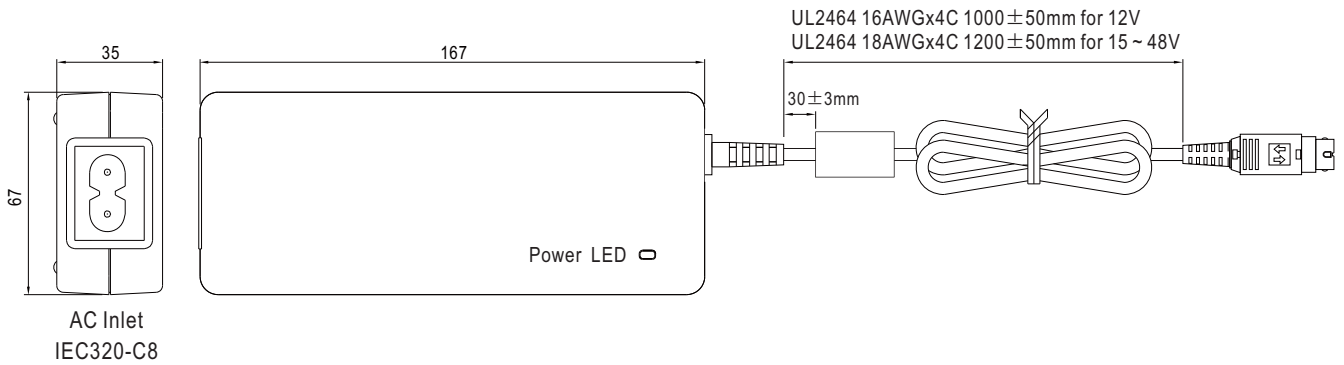









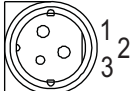
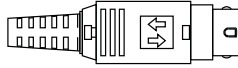

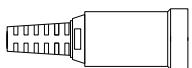

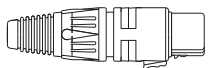

■ DC output plug

◎ Standard plug: R7B

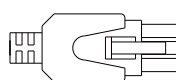
R7B		Pin Assignment											
	KYCON KPPX-4P equivalent												
		<table border="1"> <thead> <tr> <th>PIN NO.</th> <th>OUTPUT</th> </tr> </thead> <tbody> <tr><td>1</td><td>+Vo</td></tr> <tr><td>2</td><td>-Vo</td></tr> <tr><td>3</td><td>-Vo</td></tr> <tr><td>4</td><td>+Vo</td></tr> </tbody> </table>	PIN NO.	OUTPUT	1	+Vo	2	-Vo	3	-Vo	4	+Vo	
PIN NO.	OUTPUT												
1	+Vo												
2	-Vo												
3	-Vo												
4	+Vo												

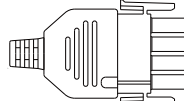
© Optional DC plug:

Min. DIN 3 Pin with Lock (male)	Type No.	Pin Assignment	
		PIN No.	Output
   <p>KYCON KPPX-3P equivalent</p>	R6B	1	+Vo
		2	-Vo
		3	+Vo
Min. DIN 4 Pin with Lock (female)	Type No.	Pin Assignment	
   <p>KYCON KPJX-CM-4S equivalent</p>	R7BF	1	+Vo
		2	-Vo
		3	-Vo
		4	+Vo
DIN 5 Pin (male)	Type No.	Pin Assignment	
  	R1B	1	-Vo
		2	-Vo
		3	+Vo
		4	-Vo
		5	+Vo
NEUTRIK XLR NC4FX equivalent	Type No.	Pin Assignment	
  	MIC4	1	+Vo
		2	+Vo
		3	-Vo
		4	-Vo
MOLEX 39-01-2060 (4.2mm) equivalent	Type No.	Pin Assignment	
   <p>FG not connected to output connector</p>	C6P	1	+Vo
		2	+Vo
		3	+Vo
		4	-Vo
		5	-Vo
		6	-Vo
AMP 1-480702-0 (6.35mm) equivalent	Type No.	Pin Assignment	
   <p>FG not connected to output connector</p>	C4P	1	+Vo
		2	+Vo
		3	-Vo
		4	-Vo

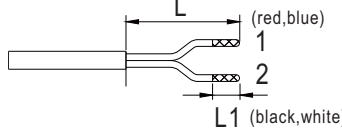
Stripped and tinned leads	Type No.	Pin Assignment	
		PIN No.	Output
  <p>Length of Land L1 by request (MW's standard length, L: <u>25</u> mm, L1: <u>5</u> mm)</p>	by customer	1	+Vo
		2	-Vo

■ **Installation Manual**

Please refer to : <http://www.meanwell.com/manual.html>