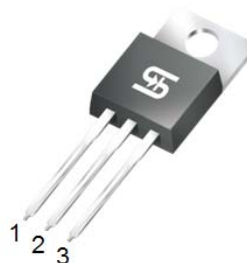

## 8A, 50V - 600V Glass Passivated Super Fast Rectifiers

### FEATURES

- High efficiency, low VF
- High current capability
- High surge current capability
- Low power loss
- Compliant to RoHS Directive 2011/65/EU and in accordance to WEEE 2002/96/EC
- Halogen-free according to IEC 61249-2-21

**TO-220AB**

### MECHANICAL DATA

**Case:** TO-220AB

Molding compound, UL flammability classification rating 94V-0

Part no. with suffix "H" means AEC-Q101 qualified

Packing code with suffix "G" means green compound (halogen-free)

**Terminal:** Matte tin plated leads, solderable per JESD22-B102

Meet JESD 201 class 2 whisker test

**Polarity:** As marked

**Mounting torque:** 0.56 Nm max.

**Weight:** 1.82 g (approximately)



MAXIMUM RATINGS AND ELECTRICAL CHARACTERISTICS (T <sub>A</sub> =25°C unless otherwise noted)										
PARAMETER	SYMBOL	SF 801G	SF 802G	SF 803G	SF 804G	SF 805G	SF 806G	SF 807G	SF 808G	UNIT
Maximum repetitive peak reverse voltage	V <sub>RRM</sub>	50	100	150	200	300	400	500	600	V
Maximum RMS voltage	V <sub>RMS</sub>	35	70	105	140	210	280	350	480	V
Maximum DC blocking voltage	V <sub>DC</sub>	50	100	150	200	300	400	500	600	V
Maximum average forward rectified current	I <sub>F(AV)</sub>	8								A
Peak forward surge current, 8.3 ms single half sine-wave superimposed on rated load	I <sub>FSM</sub>	125								A
Maximum instantaneous forward voltage (Note 1) @ 4 A	V <sub>F</sub>	0.975			1.3		1.7			V
Maximum reverse current @ rated V <sub>R</sub> T <sub>J</sub> =25°C T <sub>J</sub> =100°C	I <sub>R</sub>	10				400				μA
Maximum reverse recovery time (Note 2)	t <sub>rr</sub>	35								ns
Typical junction capacitance (Note 3)	C <sub>J</sub>	70				50				pF
Typical thermal resistance	R <sub>θJC</sub>	3								°C/W
Operating junction temperature range	T <sub>J</sub>	- 55 to +150								°C
Storage temperature range	T <sub>STG</sub>	- 55 to +150								°C

Note 1: Pulse test with PW=300μs, 1% duty cycle

Note 2: Test conditions: I<sub>F</sub>=0.5A, I<sub>R</sub>=1.0A, I<sub>RR</sub>=0.25A.

Note 3: Measured at 1 MHz and applied reverse voltage of 4.0 V DC.

ORDERING INFORMATION					
PART NO.	PART NO. SUFFIX	PACKING CODE	PACKING CODE SUFFIX (*)	PACKAGE	PACKING
SF80xG (Note 1)	H	C0	G	TO-220AB	50 / Tube

Note 1: "x" defines voltage from 50V (SF801G) to 600V (SF808G)

\*: Optional available

EXAMPLE					
EXAMPLE PART NO.	PART NO.	PART NO. SUFFIX	PACKING CODE	PACKING CODE SUFFIX	DESCRIPTION
SF808GHC0G	SF808G	H	C0	G	AEC-Q101 qualified Green compound

**RATINGS AND CHARACTERISTICS CURVES**

(T<sub>A</sub>=25°C unless otherwise noted)

FIG.1 MAXIMUM FORWARD CURRENT DERATING CURVE

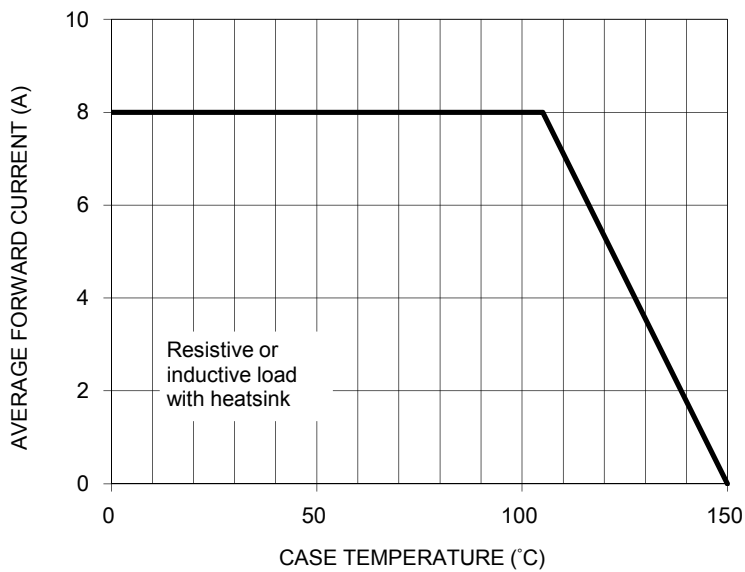

FIG. 2 TYPICAL REVERSE CHARACTERISTICS

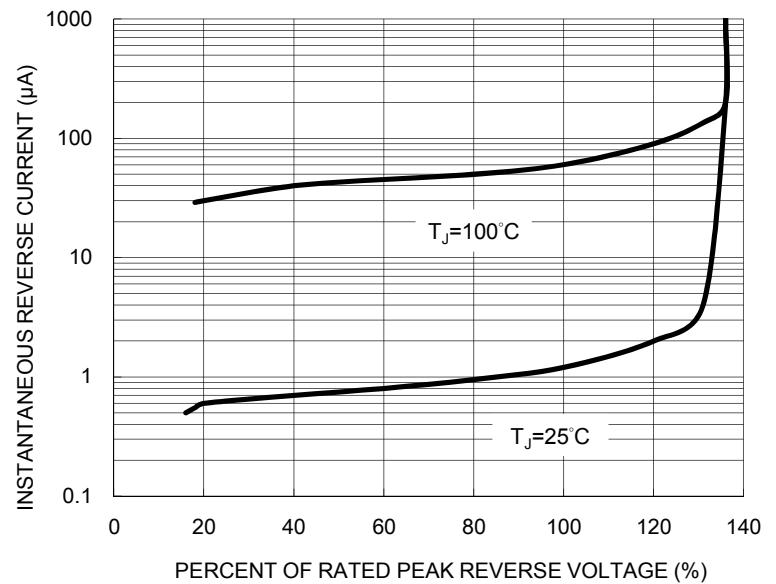

FIG. 3 MAXIMUM NON-REPETITIVE FORWARD SURGE CURRENT

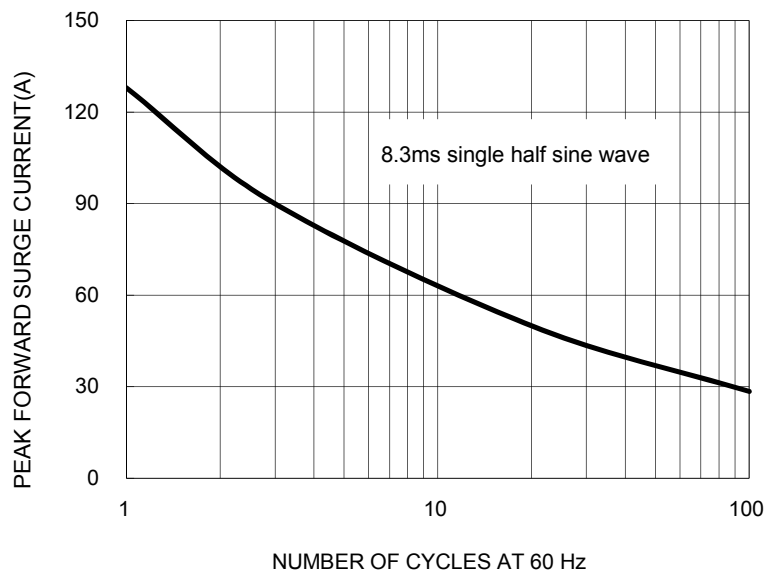

FIG. 4 TYPICAL FORWARD CHARACTERISTICS

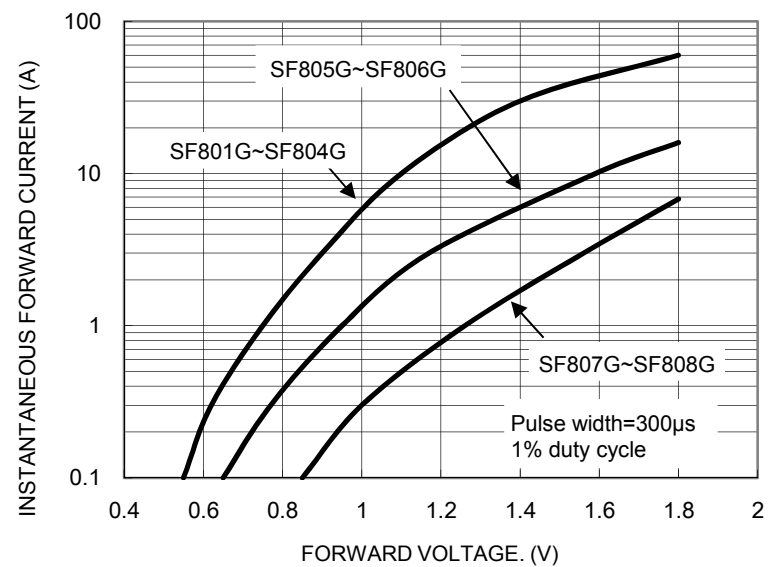

FIG. 5 TYPICAL JUNCTION CAPACITANCE

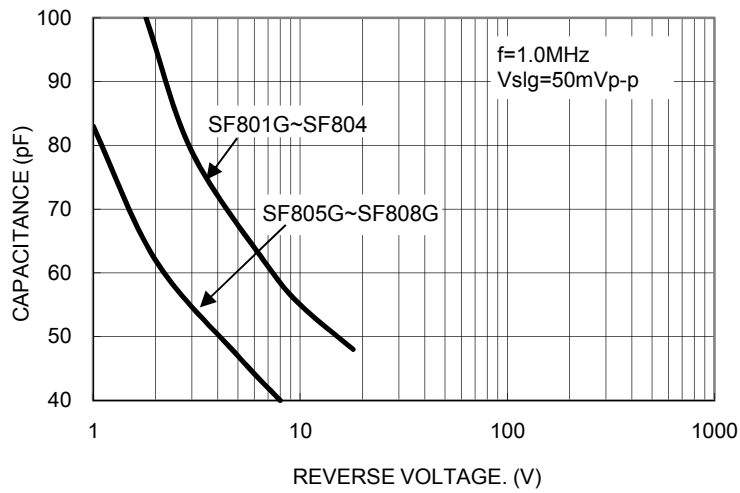
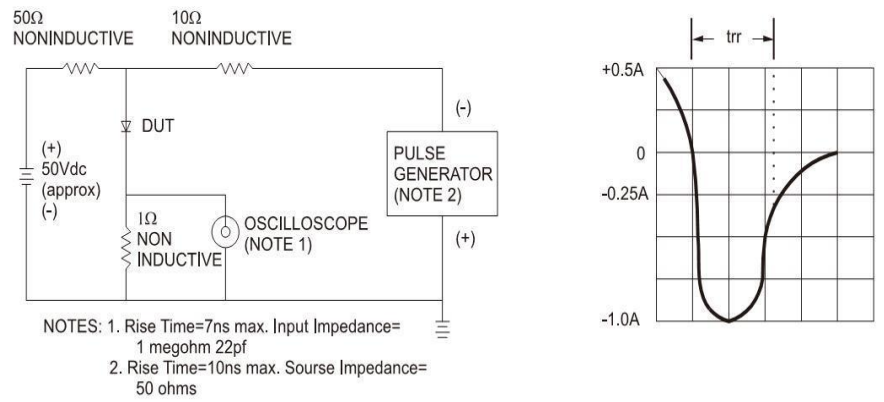
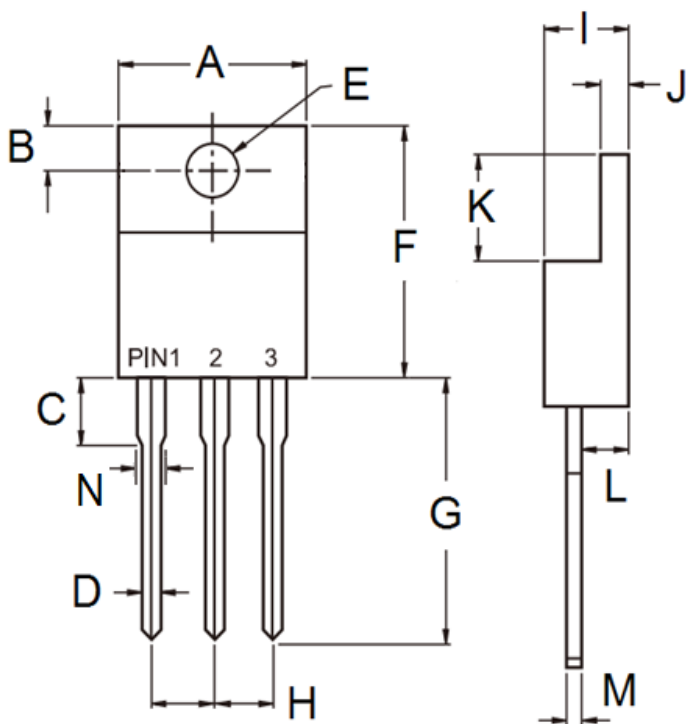

FIG.6 REVERSE RECOVERY TIME CHARACTERISTIC AND TEST CIRCUIT DIAGRAM



PACKAGE OUTLINE DIMENSIONS  
**TO-220AB**



DIM.	Unit (mm)		Unit (inch)	
	Min	Max	Min	Max
A	-	10.50	-	0.413
B	2.62	3.44	0.103	0.135
C	2.80	4.20	0.110	0.165
D	0.68	0.94	0.027	0.037
E	3.54	4.00	0.139	0.157
F	14.60	16.00	0.575	0.630
G	13.19	14.79	0.519	0.582
H	2.41	2.67	0.095	0.105
I	4.42	4.76	0.174	0.187
J	1.14	1.40	0.045	0.055
K	5.84	6.86	0.230	0.270
L	2.20	2.80	0.087	0.110
M	0.35	0.64	0.014	0.025
N	1.14	1.77	0.045	0.070

MARKING DIAGRAM



- P/N = Specific Device Code
- G = Green Compound
- YWW = Date Code
- F = Factory Code

## Notice

Specifications of the products displayed herein are subject to change without notice. TSC or anyone on its behalf, assumes no responsibility or liability for any errors or inaccuracies.

Information contained herein is intended to provide a product description only. No license, express or implied, to any intellectual property rights is granted by this document. Except as provided in TSC's terms and conditions of sale for such products, TSC assumes no liability whatsoever, and disclaims any express or implied warranty, relating to sale and/or use of TSC products including liability or warranties relating to fitness for a particular purpose, merchantability, or infringement of any patent, copyright, or other intellectual property right.

The products shown herein are not designed for use in medical, life-saving, or life-sustaining applications. Customers using or selling these products for use in such applications do so at their own risk and agree to fully indemnify TSC for any damages resulting from such improper use or sale.