

QUICK START GUIDE FOR DEMONSTRATION CIRCUIT 1031A-B

36V-72VIN, SYNCHRONOUS FORWARD CONVERTER

LTC3725 / LTC3726

DESCRIPTION

Demonstration circuit 1031A-B is a 36V-72Vin, synchronous forward converter featuring the LTC3725/LTC3726. This circuit was designed specifically to attain a high current, low ripple, synchronously rectified forward converter to efficiently power 3.3V loads at up to 20A from a typical telecom input voltage range. This circuit features secondary-

side control of the supply eliminating the need for an optocoupler, self-starting architecture, input under-voltage lockout, and output overvoltage protection.

Design files for this circuit board are available. Call the LTC factory.

 , LTC and LT are registered trademarks of Linear Technology Corporation.

Table 1. Performance Summary (T_A = 25°C)

| PARAMETER | CONDITION | VALUE |
|--|--|----------------------|
| Minimum Input Voltage | | 36V |
| Maximum Input Voltage | | 72V |
| Output Voltage V _{OUT} | V _{IN} = 36V to 72V, I _{OUT} = 0A to 20A | 3.3V |
| Maximum Output Current | 200LFM Airflow | 20A |
| Typical Output Ripple V _{OUT} | V _{IN} = 72V, I _{OUT} = 20A | 100mV _{P-P} |
| Size | Component Area x Top Component Height | 2.3" x 0.9" x 0.394" |
| Load Transient Response | Peak Deviation with Load Step of 10A to 20A (10A/us) | ±200mV |
| | Settling Time | 40us |
| Nominal Switching Frequency | | 200kHz |
| Efficiency | V _{IN} = 48V, I _{OUT} = 20A | 91.5% Typical |

OPERATING PRINCIPLES

The LTC3726 controller is used on the secondary and the LTC3725 driver with self-starting capability is used on the primary. When an input voltage is applied, the LTC3725 begins a controlled soft-start of the output voltage. As this voltage begins to rise, the LTC3726 secondary controller is quickly powered up via T1, D25, and Q27. The LTC3726 then assumes control of the output voltage by sending encoded PWM gate pulses to the LTC3725 primary driver via the small signal transformer, T2. The LTC3725 then operates as a simple driver receiving both input signals and bias power through T2.

The transition from primary to secondary control occurs seamlessly at a fraction of the output voltage. From that point on, operation and design simplifies to that of a simple buck converter. Secondary sensing eliminates delays, tames large-signal overshoot and reduces output capacitance while utilizing off-the-shelf magnetics and attaining high efficiency.

For large values of input inductance, a 100V, 47uF electrolytic capacitor can be added across the input terminals to damp the input filter and provide adequate stability. See Linear Technology Application Note AN19 for a discussion on input filter stability analysis. A recommended part is the Sanyo 100MV39AX.

QUICK START PROCEDURE

Demonstration circuit 1031A-B is easy to set up to evaluate the performance of the LTC3725/LTC3726. Refer to Figure 1 for proper measurement equipment setup and follow the procedure below:

NOTE: When measuring the input or output voltage ripple, care must be taken to avoid a long ground lead on the oscilloscope probe. Measure the output (or input) voltage ripple by touching the probe tip and probe ground directly across the input or output capacitor. See Figure 2 for proper scope probe technique.

1. Set an input power supply that is capable of 36V to 72V at a current of at least 2.5A to a voltage of 36V. Then, turn off the supply.
2. With power off, connect the supply to the input terminals +Vin and -Vin.
 - a. Input voltages lower than 36V can keep the converter from turning on due to the undervoltage lockout feature of the LTC3725/LTC3726.
 - b. If efficiency measurements are desired, an ammeter capable of measuring 2.5A_{dc} can be put in series with the input supply in order to measure the DC1031A-B's input current.
 - c. A voltmeter with a capability of measuring at least 72V can be placed across the input terminals in order to get an accurate input voltage measurement.
3. Turn on the power at the input.

NOTE: Make sure that the input voltage never exceeds 72V.
4. Check for the proper output voltage of 3.3V
5. Turn off the power at the input.
6. Once the proper output voltages are established, connect a variable load capable of sinking 20A at 3.3V to the output terminals +Vout and -Vout. Set the current for 0A.
 - a. If efficiency measurements are desired, an ammeter or a resistor current shunt that is capable of handling at least 20A_{dc} can be put in series with the output load in order to measure the DC1031A-B's output current.
 - b. A voltmeter with a capability of measuring at least 3.3V can be placed across the output terminals in order to get an accurate output voltage measurement.
7. Turn on the power at the input.

NOTE: If there is no output, temporarily disconnect the load to make sure that the load is not set too high.
8. Once the proper output voltage is established, adjust the load within the operating range and observe the output voltage regulation, ripple voltage, efficiency and other desired parameters.

QUICK START GUIDE FOR DEMONSTRATION CIRCUIT 1031A-B

36V-72VIN, SYNCHRONOUS FORWARD CONVERTER

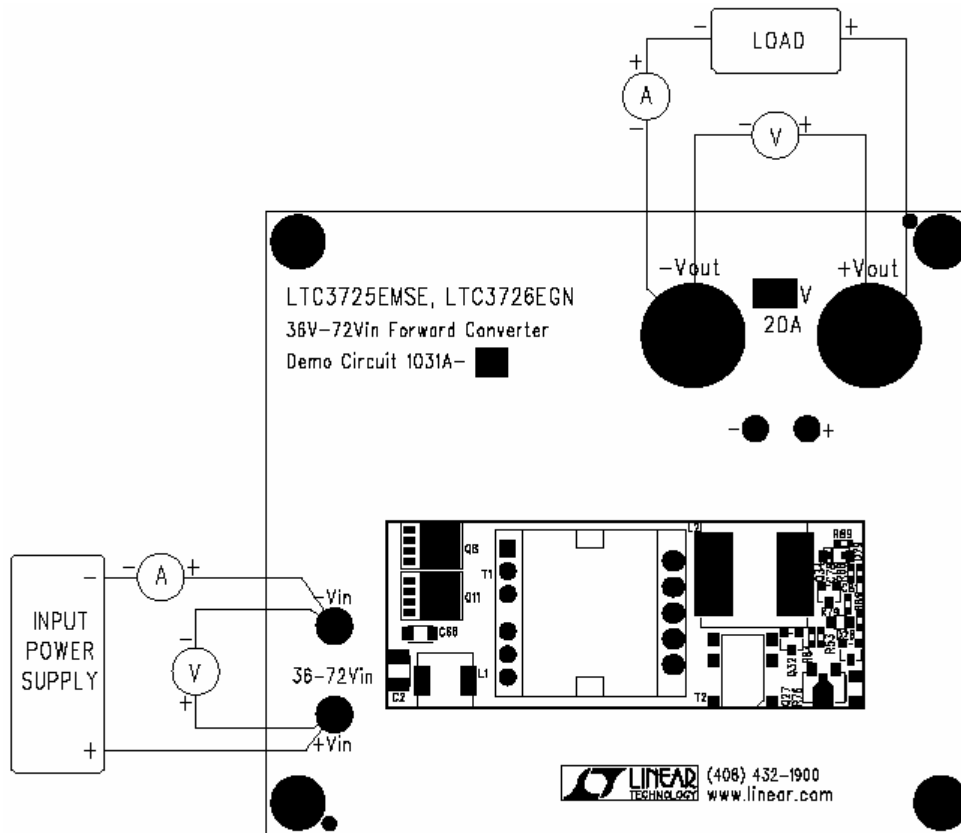

Figure 1. Proper Measurement Equipment Setup

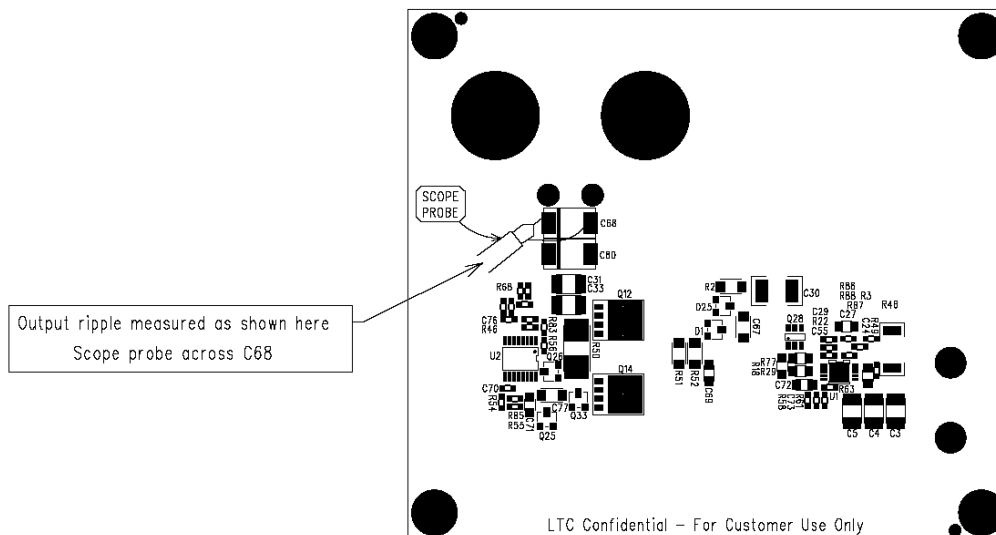

Figure 2. Measuring Input or Output Ripple

MEASURED DATA

Figures 3 through 11 are measured data for a typical DC1031A-B. Figures 12 through 21 are schematics, bill of materials and layout.

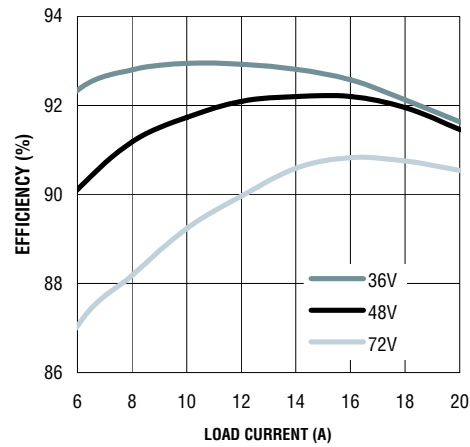

Figure 3. Efficiency (200lfm airflow)

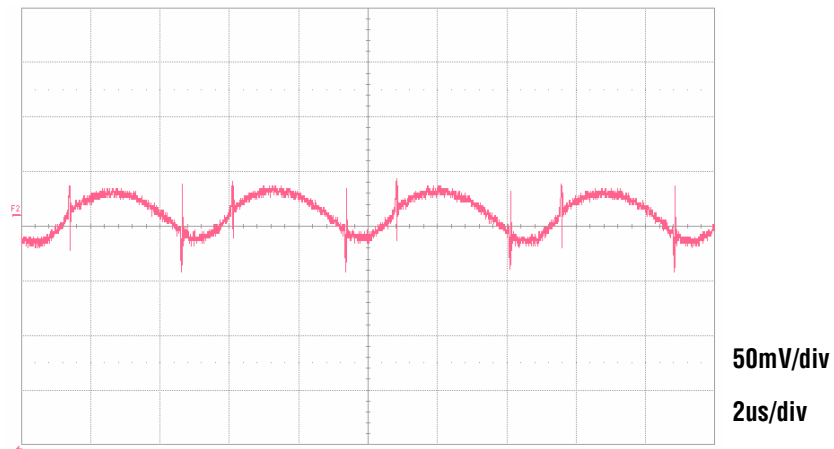

Figure 4. Output Ripple Voltage (72Vin, 20Aout)

QUICK START GUIDE FOR DEMONSTRATION CIRCUIT 1031A-B

36V-72VIN, SYNCHRONOUS FORWARD CONVERTER

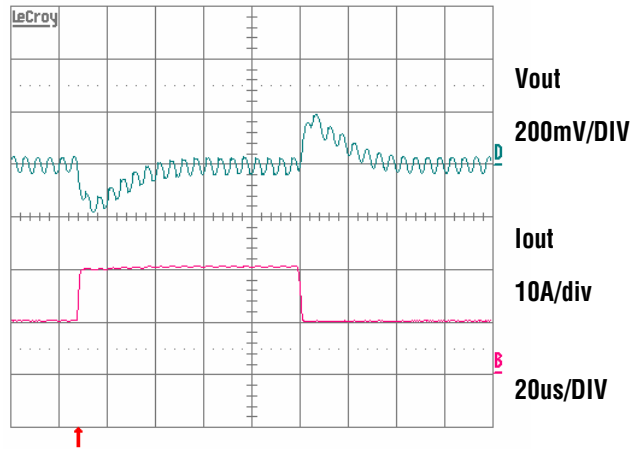

Figure 5. Output Voltage Transient Response (48Vin, 10A to 20A step)

QUICK START GUIDE FOR DEMONSTRATION CIRCUIT 1031A-B

36V-72VIN, SYNCHRONOUS FORWARD CONVERTER



Figure 6. Temp Data (48Vin, 20A, 25°C, 200LFM airflow – front)

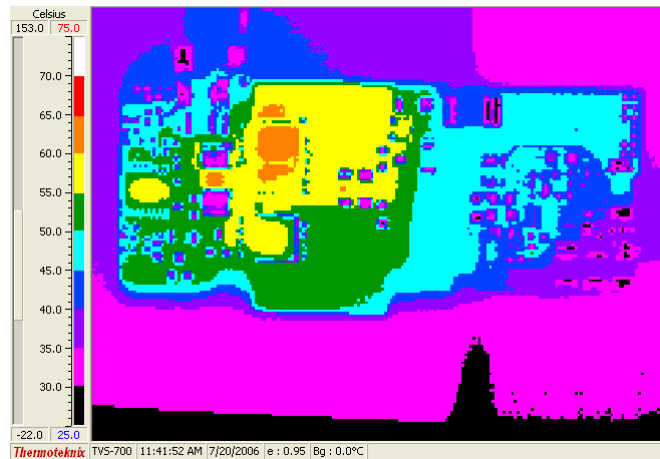

Figure 7. Temp Data (48Vin, 20A, 25°C, 200LFM airflow – back)



Figure 8. Temp Data (36Vin, 20A, 25°C, 200LFM airflow – front)

QUICK START GUIDE FOR DEMONSTRATION CIRCUIT 1031A-B

36V-72VIN, SYNCHRONOUS FORWARD CONVERTER

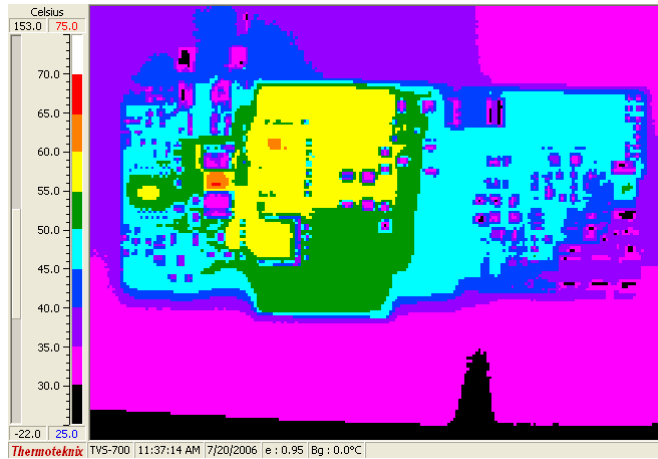

Figure 9. Temp Data (36Vin, 20A, 25°C, 200LFM airflow – back)



Figure 10. Temp Data (72Vin, 20A, 25°C, 200LFM airflow – front)

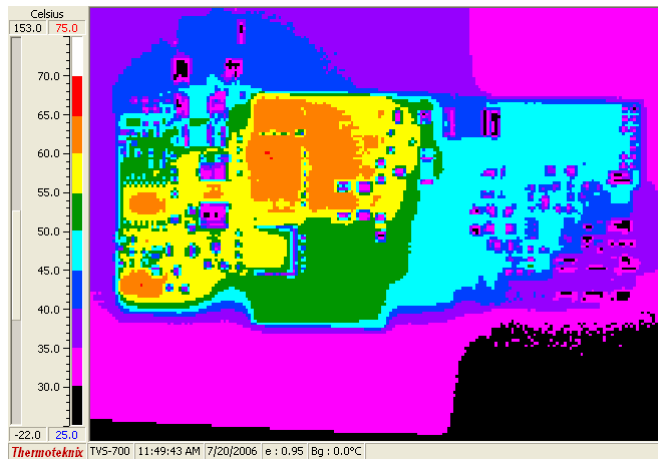

Figure 11. Temp Data (72Vin, 20A, 25°C, 200LFM airflow – back)

QUICK START GUIDE FOR DEMONSTRATION CIRCUIT 1031A-B

36V-72VIN, SYNCHRONOUS FORWARD CONVERTER

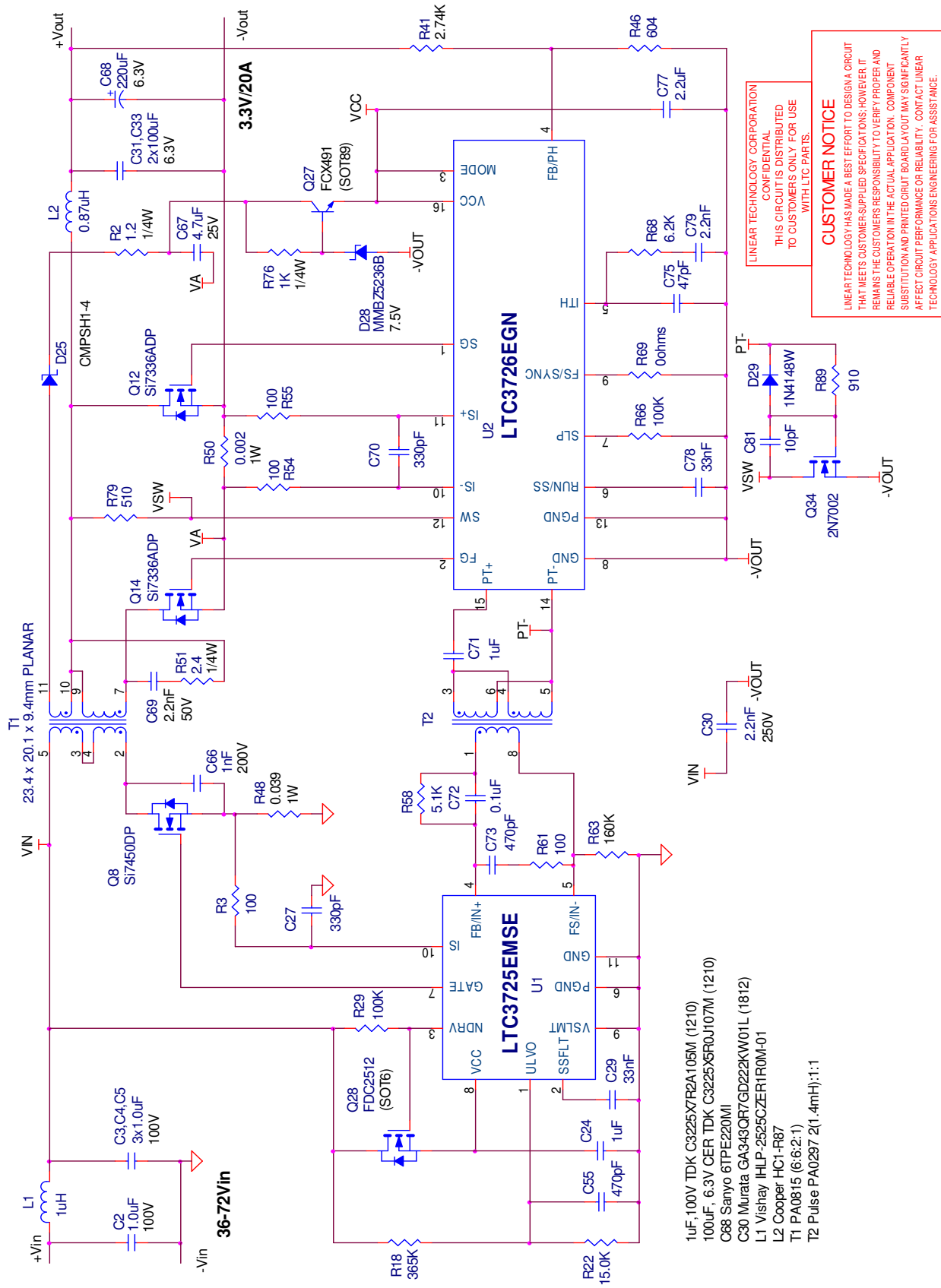

Figure 12. Simplified Schematic

LINEAR TECHNOLOGY CORPORATION
CONFIDENTIAL
 THIS CIRCUIT IS DISTRIBUTED
 TO CUSTOMERS ONLY FOR USE
 WITH LTC PARTS.

CUSTOMER NOTICE
 LINEAR TECHNOLOGY HAS MADE A BEST EFFORT TO DESIGN A CIRCUIT
 THAT MEETS CUSTOMER-SUPPLIED SPECIFICATIONS; HOWEVER, IT
 REMAINS THE CUSTOMER'S RESPONSIBILITY TO VERIFY PROPER AND
 RELIABLE OPERATION IN THE ACTUAL APPLICATION. COMPONENT
 SUBSTITUTION AND PRINTED CIRCUIT BOARD LAYOUT MAY SIGNIFICANTLY
 AFFECT CIRCUIT PERFORMANCE OR RELIABILITY. CONTACT LINEAR
 TECHNOLOGY APPLICATIONS ENGINEERING FOR ASSISTANCE.

QUICK START GUIDE FOR DEMONSTRATION CIRCUIT 1031A-B

36V-72VIN, SYNCHRONOUS FORWARD CONVERTER

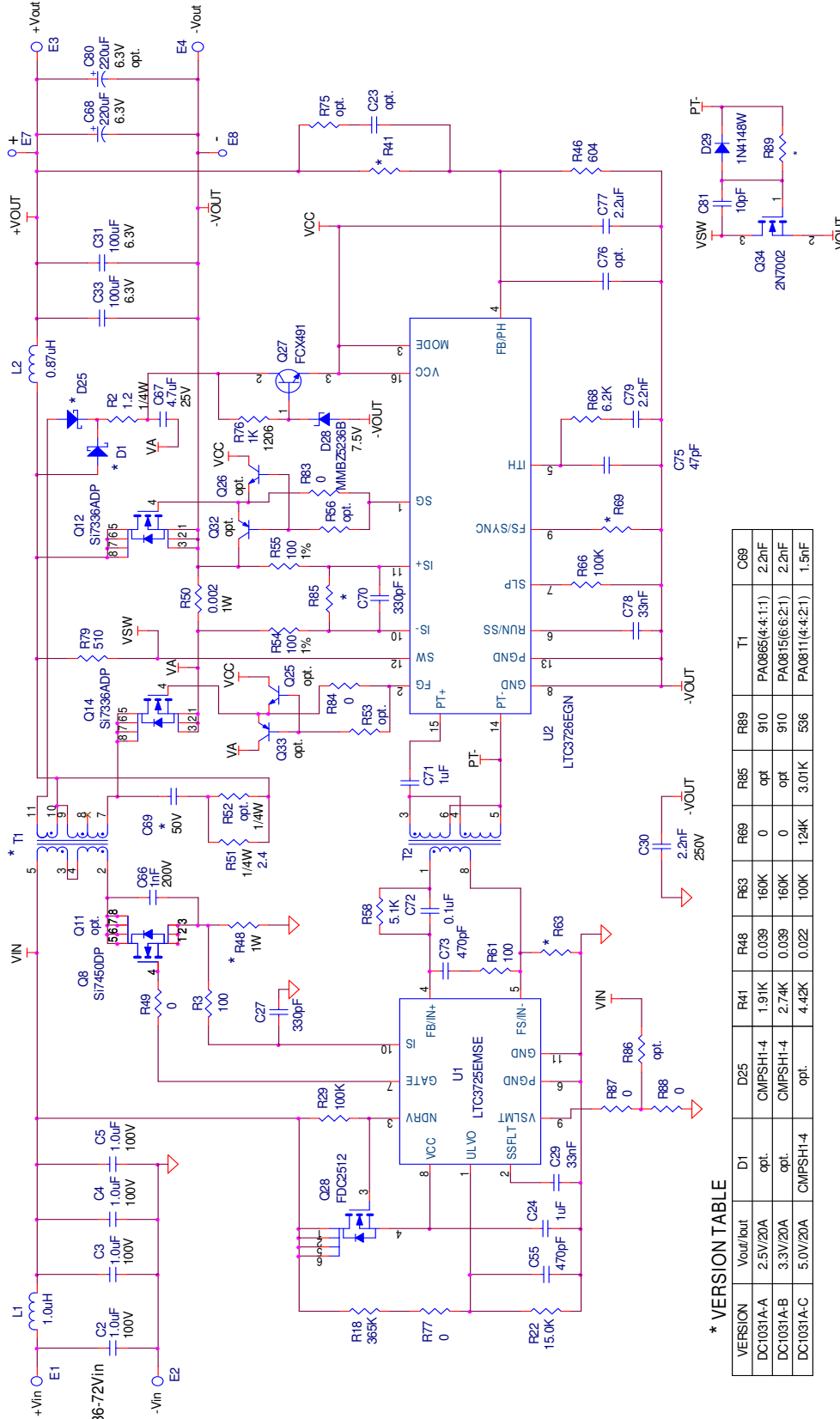

* VERSION TABLE

| VERSION | Volts/Unit | D1 | D25 | R41 | R48 | R63 | R85 | R89 | T1 | C89 |
|-----------|------------|------|----------|-------|-------|------|------|-------|-----------------|-------|
| DC1031A-A | 2.5V/20A | opt. | CMP5H1-4 | 1.91K | 0.039 | 160K | 0 | opt. | PA0865(4:4:1:1) | 2.2nF |
| DC1031A-B | 3.3V/20A | opt. | CMP5H1-4 | 2.74K | 0.039 | 160K | 0 | opt. | PA0815(6:6:2:1) | 2.2nF |
| DC1031A-C | 5.0V/20A | opt. | CMP5H1-4 | 4.42K | 0.022 | 100K | 124K | 3.01K | PA0811(4:4:2:1) | 1.5nF |

For All The Versions
 C2-C5 1uF, 100V TDK C3225X7R2A105M (1210)
 C31, C33 100uF, 6.3V CER TDK C3225X5R0107M (1210)
 C68 Sanyo 61P2220M1
 L1 Vishay HLP-2525CZER1R0M-01 or
 COOPER HCP0703-1R0-R
 L2 Coil Tronics HCl-1R87
 T2 Pulse PA0297 2(1.4mH):1:1

CUSTOMER NOTICE
 LINEAR TECHNOLOGY HAS MADE A BEST EFFORT TO DESIGN A CIRCUIT THAT MEETS CUSTOMER-SUPPLIED SPECIFICATIONS. HOWEVER, IT REMAINS THE CUSTOMER'S RESPONSIBILITY TO VERIFY PROPER AND RELIABLE OPERATION IN THE ACTUAL APPLICATION. COMPONENT SUBSTITUTION AND PRINTED CIRCUIT BOARD LAYOUT MAY SIGNIFICANTLY AFFECT CIRCUIT PERFORMANCE OR RELIABILITY. CONTACT LINEAR TECHNOLOGY APPLICATIONS ENGINEERING FOR ASSISTANCE.
 THIS CIRCUIT IS PROPRIETARY TO LINEAR TECHNOLOGY AND SUPPLIED FOR USE WITH LINEAR TECHNOLOGY PARTS.

CONTRACT NO. _____
 APPROVALS _____ DATE 12/5/05
 DRAWN J. WU
 CHECKED _____
 APPROVED _____
 ENGINEER K. Mathews 12/5/05
 DESIGNER _____

TITLE
 LTC3725EMSE, LTC3726EGN, 36V - 72Vin Forward Converter

SIZE _____ DWG NO DC1031A
 SCALE _____ FILENAME _____
 Wednesday, August 23, 2006

REV A
 SHEET 1 OF 1

QUICK START GUIDE FOR DEMONSTRATION CIRCUIT 1031A-B

36V-72VIN, SYNCHRONOUS FORWARD CONVERTER

| <i>Item</i> | <i>Qty</i> | <i>Reference</i> | <i>Part Description</i> | <i>Manufacture / Part #</i> |
|--|------------|--------------------|---------------------------------------|---------------------------------|
| REQUIRED CIRCUIT COMPONENTS¹ | | | | |
| 1 | 4 | C2,C3,C4,C5 | CAP., X7R, 1.0uF, 100V, 20%, 1210 | TDK, C3225X7R2A105M |
| 2 | 2 | C71,C24 | CAP., X7R, 1uF, 16V 10%, 0805 | TAIYO YUDEN, EMK212BJ105KG |
| 3 | 2 | C27,C70 | CAP., X7R, 330pF, 25V, 10%, 0603 | AVX, 06033C331KAT2A |
| 4 | 2 | C29,C78 | CAP., X7R, 33nF, 25V, 10%, 0603 | AVX, 06033C333KAT2A |
| 5 | 1 | C30 | CAP., X7R, 2.2nF, 250V, 10%, 1812 | MURATA, GA343QR7GD222KW01L |
| 6 | 2 | C31,C33 | CAP., X5R, 100uF, 6.3V, 20%, 1210 | TDK, C3225X5R0J107M |
| 7 | 2 | C73,C55 | CAP., C0G, 470pF, 25V, 10%, 0603 | AVX, 06033A471KAT2A |
| 8 | 1 | C66 | CAP., C0G, 1nF, 200V, 10%, 1206 | AVX, 12062A102KAT2A |
| 9 | 1 | C67 | CAP., X7R, 4.7uF, 25V, 20%, 1206 | TDK, C3216X7R1E475M |
| 10 | 1 | C68 | CAP., POSCAP, 220uF, 6.3V, 20% 7343 | SANYO, 6TPE220MI |
| 11 | 1 | C69 | CAP., NPO, 2.2nF, 50V, 10%, 0805 | AVX, 08055A222KAT2A |
| 12 | 1 | C72 | CAP., X7R, 0.1uF, 25V, 10%, 0805 | AVX, 08053C104KAT2A |
| 13 | 1 | C75 | CAP., NPO, 47pF, 25V, 10%, 0603 | AVX, 06033A470KAT2A |
| 14 | 1 | C77 | CAP., X7R, 2.2uF, 16V, 20%, 1206 | TDK, C3216X7R1C225M |
| 15 | 1 | C79 | CAP., X7R, 2.2nF, 25V, 10%, 0603 | AVX, 06033C222KAT2A |
| 16 | 1 | C81 | CAP., C0G, 10pF, 50V, 5%, 0603 | AVX, 06035A100JAT2A |
| 17 | 1 | D25 | DIODE, Schottky, CMPSH1-4, 40V, SOT23 | CENTRAL SEMI., CMPSH1-4-LTC |
| 18 | 1 | D28 | Diode, MMBZ5236B, SOT23 | DIODES INC., MMBZ5236B-7 |
| 19 | 1 | D29 | Diode, 1N4148W SOD-123 | DIODES INC., 1N4148W-7-F |
| 20 | 1 | L1 | INDUCTOR, 1.0uH | VISHAY DALE, IHLP2525CZER1R0M01 |
| | 0 | L1 (second source) | INDUCTOR, 1.0uH | COOPER, HCP0703-1R0-R |
| 21 | 1 | L2 | INDUCTOR, 0.87uH | COOPER, HC1-R87 |
| 22 | 1 | Q8 | FET, N-CH., Si7450DP, POWERPAK SO-8 | VISHAY, Si7450DP |
| 23 | 2 | Q12,Q14 | FET, N-CH., Si7336ADP, POWERPAK SO-8 | VISHAY, Si7336ADP |
| 24 | 1 | Q34 | N-CH., Transistor. 2N7002 SOT23 | DIODES INC., 2N7002-7-F |
| 25 | 1 | Q27 | NPN TRANSISTOR, FCX491 | ZETEX, FCX491 |
| 26 | 1 | Q28 | N-CH FET, 150V, FDC2512, Super SOT-6 | FAIRCHILD, FDC2512 |
| 27 | 1 | R2 | RES., CHIP, 1.2, 1/4W, 5%, 1206 | AAC, CR18-1R2JM |
| 28 | 2 | R54,R55 | RES., CHIP, 100, 1/16W, 1%, 0603 | VISHAY, CRCW06031000FRT6 |
| 29 | 1 | R18 | RES., CHIP, 365K, 1/8W, 1%, 0805 | VISHAY, CRCW0805365KFKEB |
| 30 | 1 | R22 | RES., CHIP, 15.0K, 1/16W, 1%, 0603 | AAC, CR16-1502FM |
| 31 | 1 | R29 | RES., CHIP, 100K, 1/8W, 5%, 0805 | AAC, CR10-104JM |
| 32 | 1 | R41 | RES., CHIP, 2.74K, 1/16W, 1%, 0603 | AAC, CR16-2741FM |
| 33 | 1 | R46 | RES., CHIP, 604, 1/16W, 1%, 0603 | AAC, CR16-6040FM |
| 34 | 1 | R48 | RES., CHIP, 0.039, 1W, 2%, 2010 | IRC, LRC-LR2010-01-R039-G |
| 35 | 1 | R50 | RES., CHIP, 0.002, 1W, 1%, 2512 | PANASONIC, ERJM1WTF2M0U |
| 36 | 1 | R51 | RES., CHIP, 2.4, 1/4W, 5%, 1206 | AAC, CR18-2R4JM |
| 37 | 1 | R58 | RES., CHIP, 5.1K, 1/16W, 5%, 0603 | AAC, CR16-512JM |
| 38 | 2 | R3,R61 | RES., CHIP, 100, 1/16W, 5%, 0603 | AAC, CR16-101JM |
| 39 | 1 | R63 | RES., CHIP, 160K, 1/16W, 5%, 0603 | AAC, CR16-164JM |
| 40 | 1 | R66 | RES., CHIP, 100K, 1/16W, 5%, 0603 | AAC, CR16-104JM |
| 41 | 1 | R68 | RES., CHIP, 6.2K, 1/16W, 5%, 0603 | AAC, CR16-622JM |
| 42 | 1 | R69 | RES., CHIP, 0, 1/16W, 0603 | Panasonic, ERJ3GEY0R00V |
| 43 | 1 | R76 | RES., CHIP, 1K, 1/4W, 5%, 1206 | AAC, CR18-102JM |
| 44 | 1 | R79 | RES., CHIP, 510, 1/8W, 5%, 0805 e3 | AAC, CR10-511JM |

QUICK START GUIDE FOR DEMONSTRATION CIRCUIT 1031A-B

36V-72VIN, SYNCHRONOUS FORWARD CONVERTER

| | | | | |
|---|---|------------------------|---------------------------------------|---------------------------|
| 45 | 1 | R89 | RES., CHIP, 910, 1/16W, 5%, 0603 e3 | VISHAY, CRCW0603910RJNEA |
| 46 | 1 | T1 | TRANSFORMER, 1750VDC BASIC, PA0815 | PULSE, PA0815 |
| 47 | 1 | T2 | TRANSFORMER, 1500VRMS BASIC, PA0297 | PULSE, PA0297 |
| 48 | 1 | U1 | I.C., LTC3725EMSE, MS10E | LINEAR TECH., LTC3725EMSE |
| 49 | 1 | U2 | I.C., LTC3726EGN, SSOP16GN | LINEAR TECH., LTC3726EGN |
| ADDITIONAL DEMO BOARD CIRCUIT COMPONENTS² | | | | |
| 1 | 0 | C23,C76 (opt.) | CAP., 0603 | |
| 2 | 0 | C80 (opt.) | CAP., POSCAP, 220uF, 6.3V, 20% 7343 | |
| 3 | 0 | D1 (opt.) | DIODE, Schottky, CMPSH1-4, 40V, SOT23 | |
| 4 | 0 | Q11 (opt.) | FET, N-CH, POWERPAK SO-8 | |
| 5 | 0 | Q25,Q26 (opt.) | NPN Transistor, FMMT619, SOT23 | |
| 6 | 0 | Q32,Q33 (opt.) | PNP Transistor, FMMT718, SOT23 | |
| 7 | 5 | R49,R83,R84,R87,R88 | RES., CHIP, 0, 1/16W, 0603 | Panasonic, ERJ3GEY0R00V |
| 8 | 0 | R52 (opt.) | RES., CHIP, 1206 | |
| 9 | 0 | R53,R56,R75,R85 (opt.) | RES., CHIP, 0603 | |
| 11 | 1 | R77 | RES., CHIP, 0, 1/8W, 0805 | AAC, CJ10-000M |
| 12 | 0 | R86 (opt.) | RES., CHIP, 0805 | |
| HARDWARE-FOR DEMO BOARD ONLY: | | | | |
| 1 | 2 | E1,E2 | TESTPOINT, TURRET, .094" | MILL-MAX, 2501-2 |
| 2 | 2 | E3,E4 | STUD | PEM, KFH-032-10 |
| 3 | 4 | E3,E4 (2 EACH) | NUT, BRASS, #10-32 | ANY |
| 4 | 2 | E3,E4 | Ring, Lug Ring # 10 | KEYSTONE 8205 |
| 5 | 2 | E3,E4 | WASHER, STAR #10 BRASS NICHEL | ANY |
| 6 | 2 | E8,E7 | TURRET, | MILL-MAX2308-2-00-44 |
| 7 | 4 | (STAND-OFF) | STAND-OFF, NYLON 0.50" | KEYSTONE 8833 (SNAP ON) |
| Notes: | | | | |
| 1. Required Circuit Components are those parts that are required to implement the circuit function | | | | |
| 2. Additional Demo Board Circuit Components are those parts that provide added functionality for the demo board but are not required in the actual circuit. | | | | |

Figure 14. Bill of Materials

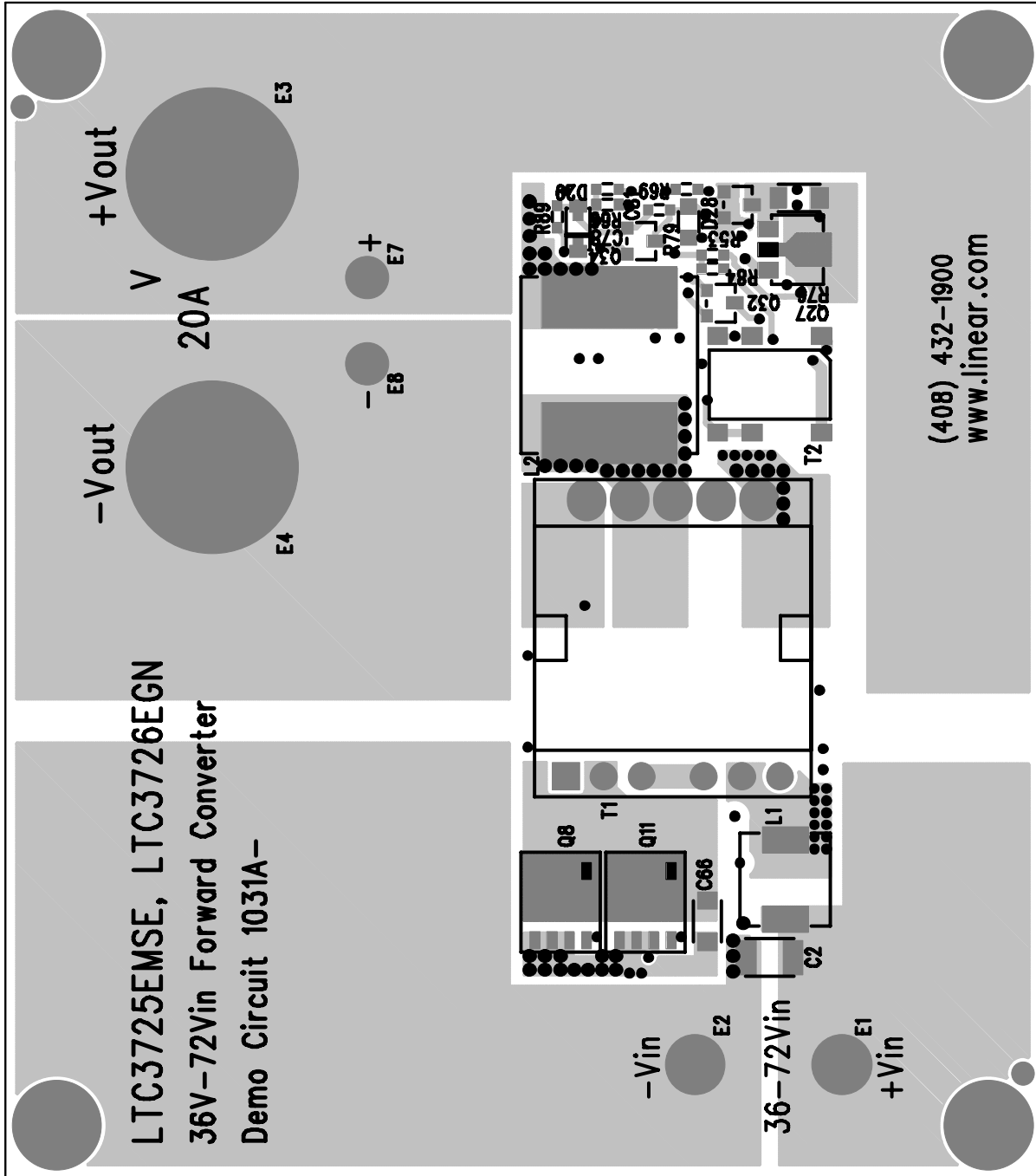

Figure 15. Top



Figure 16. Layer 2

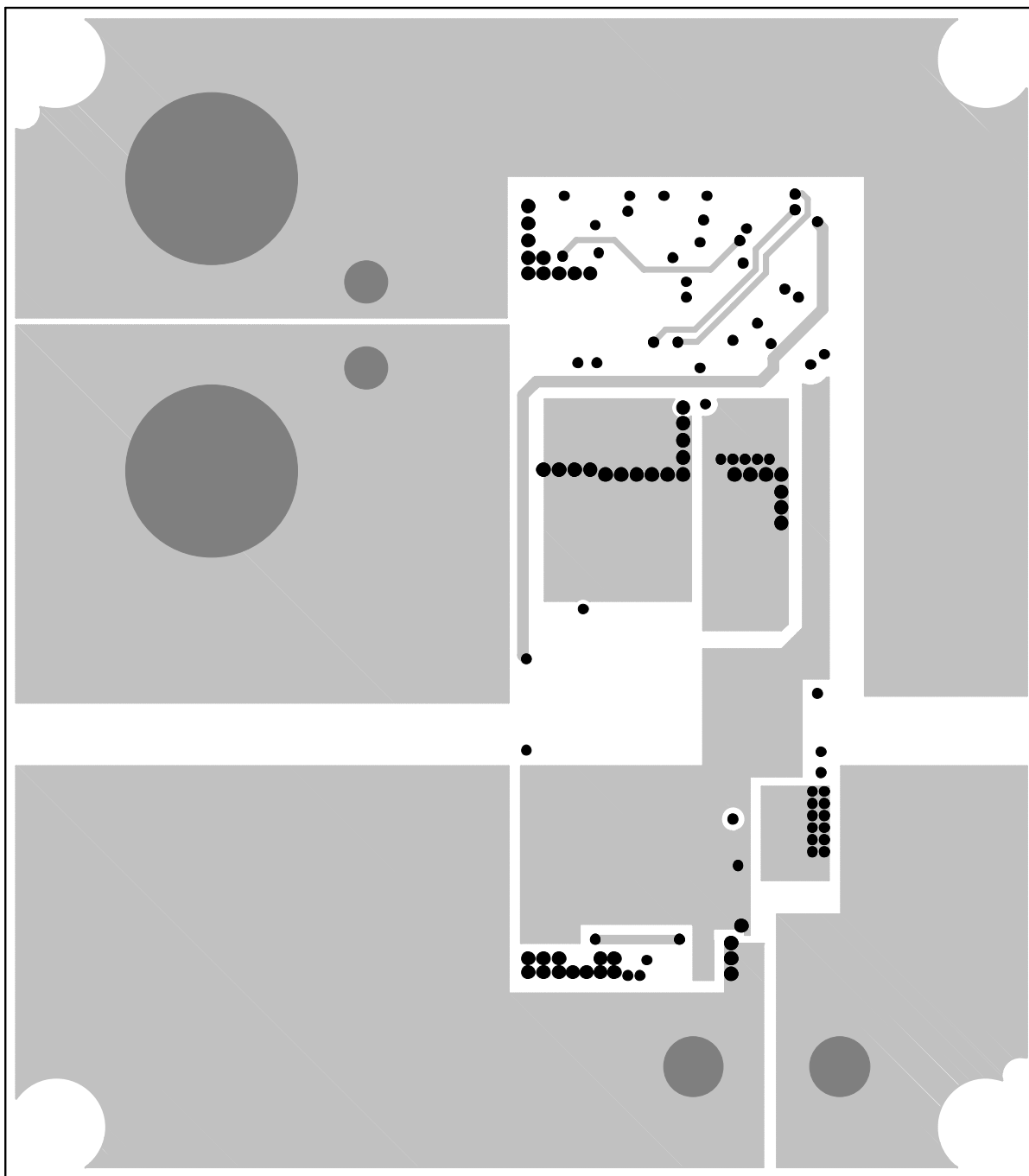

Figure 17. Layer 3

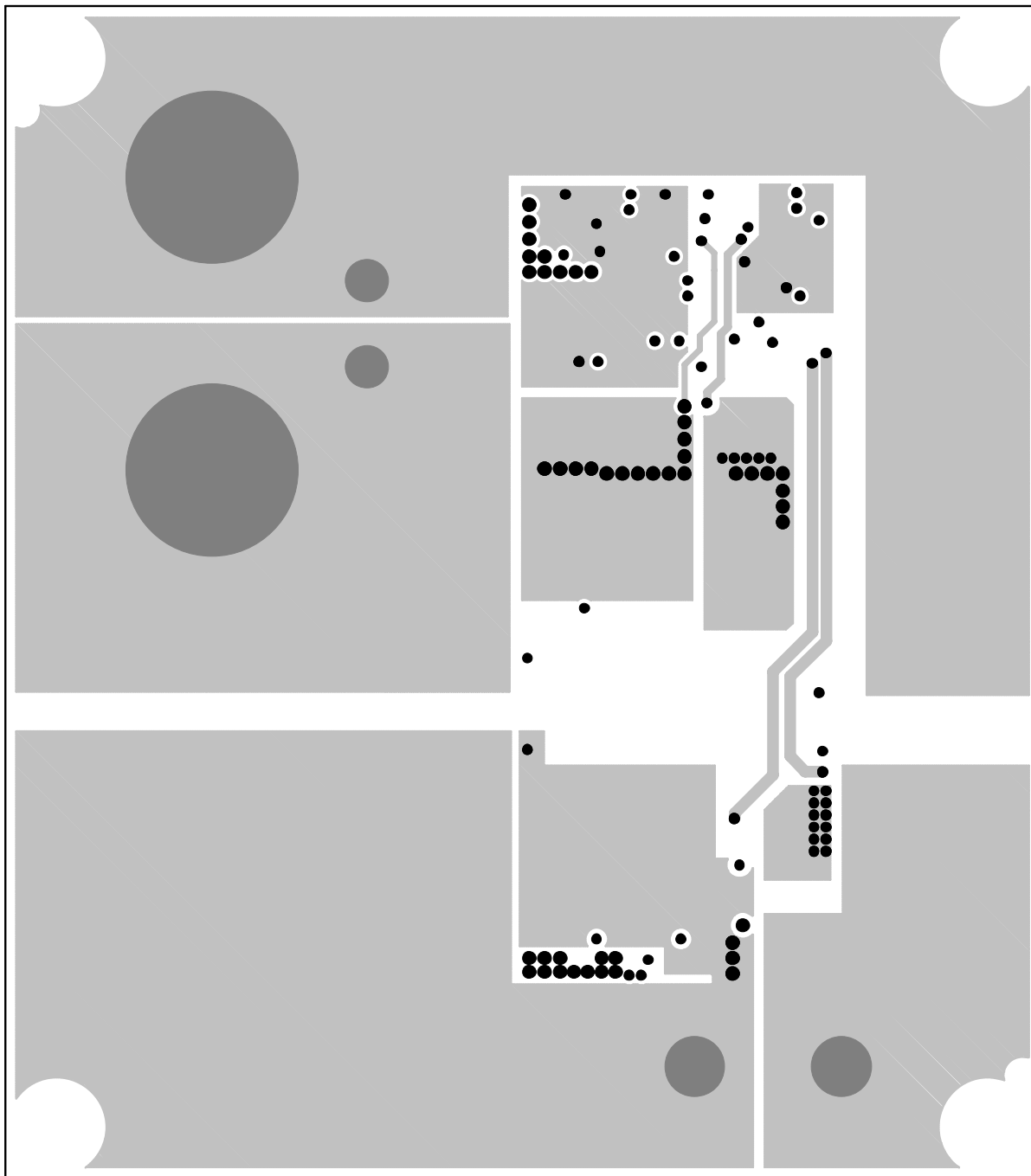

Figure 18. Layer 4

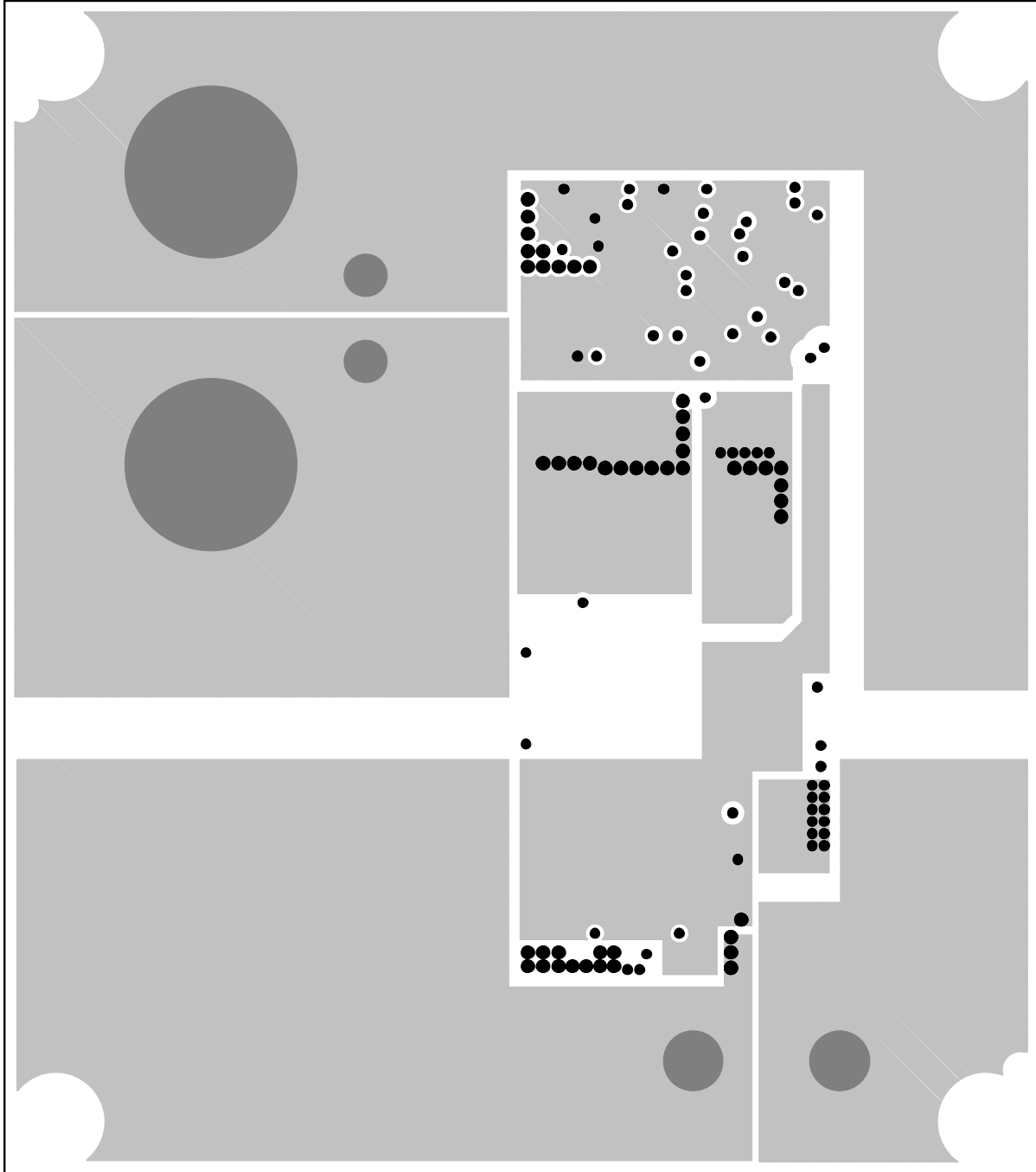

Figure 19. Layer 5

QUICK START GUIDE FOR DEMONSTRATION CIRCUIT 1031A-B

36V-72VIN, SYNCHRONOUS FORWARD CONVERTER

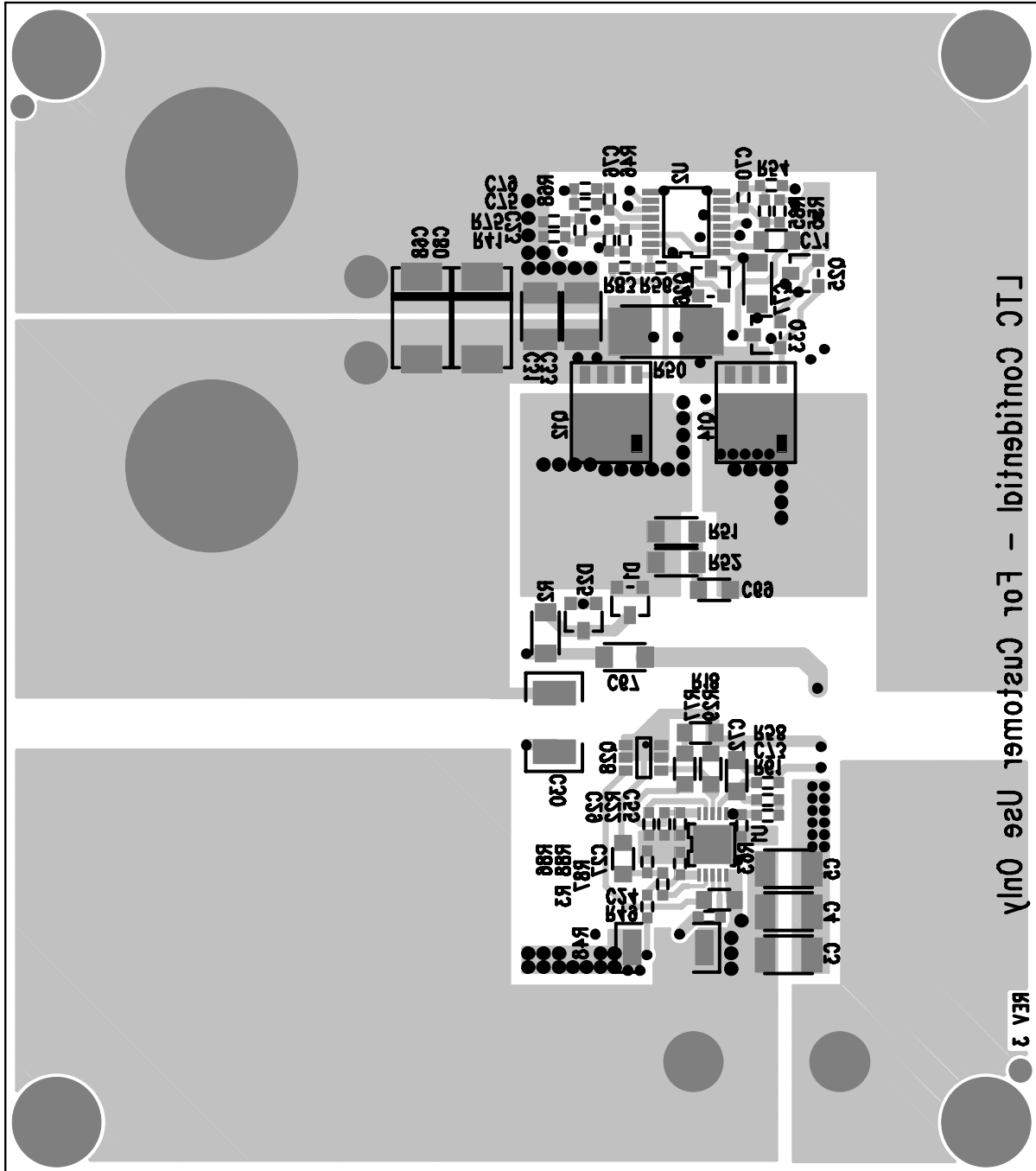

Figure 20. Bottom

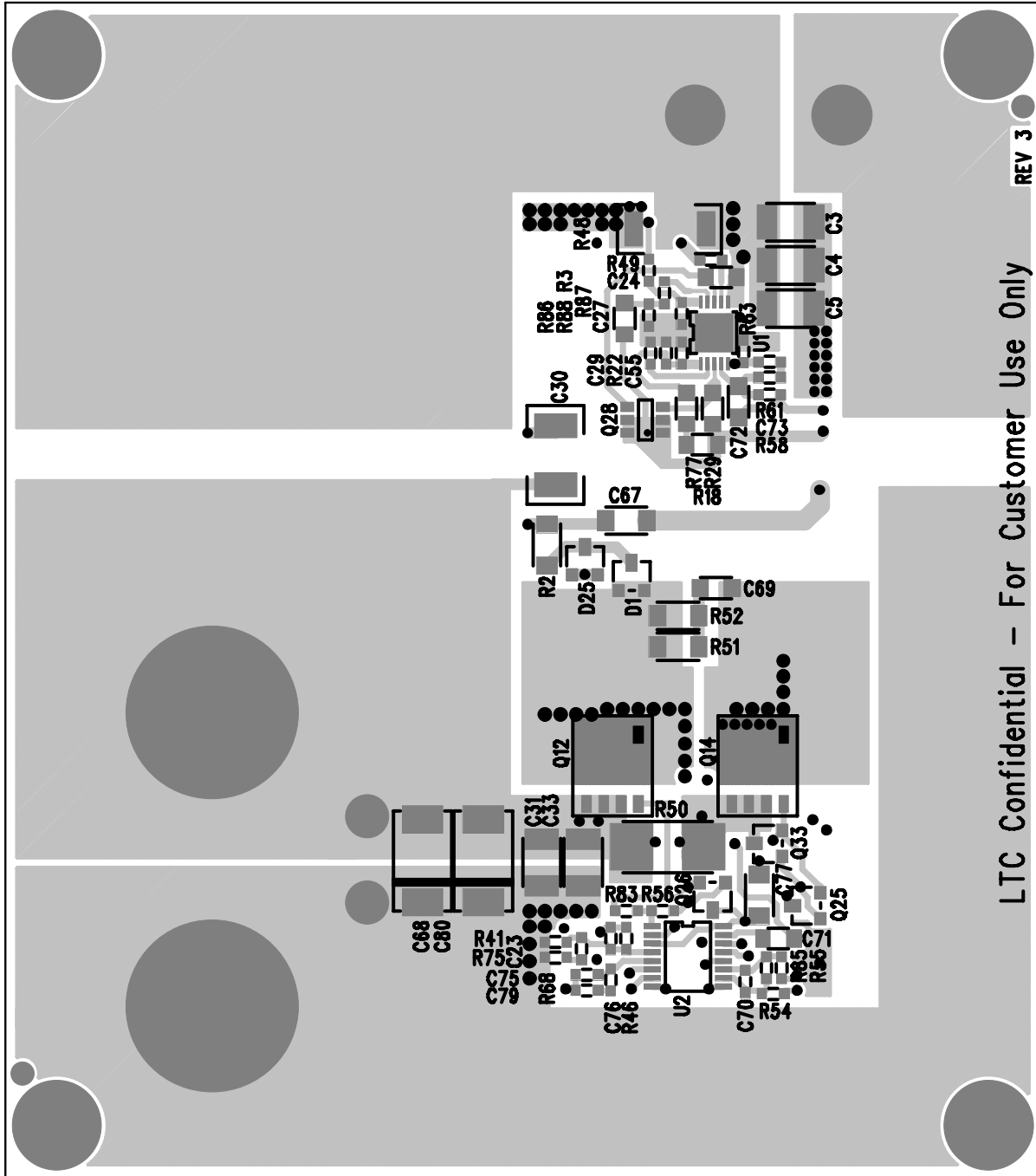

Figure 21. Bottom Mirrored