



# Technical Data Sheet

## 7343-2SURC/H2/S530-AX

### Features

- Popular T-1 3/4package.
- High efficiency.
- General purpose leads.
- Selected minimum intensities.
- Available on tape and reel.
- Pb free .



### Descriptions

- The series is specially designed for applications requiring higher brightness.
- The LED lamps are available with different colors, intensities, epoxy colors ,etc.
- Superior performance in outdoor environment.

### Applications

- Status indicators.
- Commercial use.
- Advertising Signs.

### Device Selection Guide

LED Part No.	Chip		Lens Color
	Material	Emitted Color	
7343-2SURC/H2/S530-AX	AlGaInP	Hyper Red	Water Clear
7343-2SURC/H2/S530-AX			
7343-2SURC/H2/S530-AX			

**Package Dimensions**

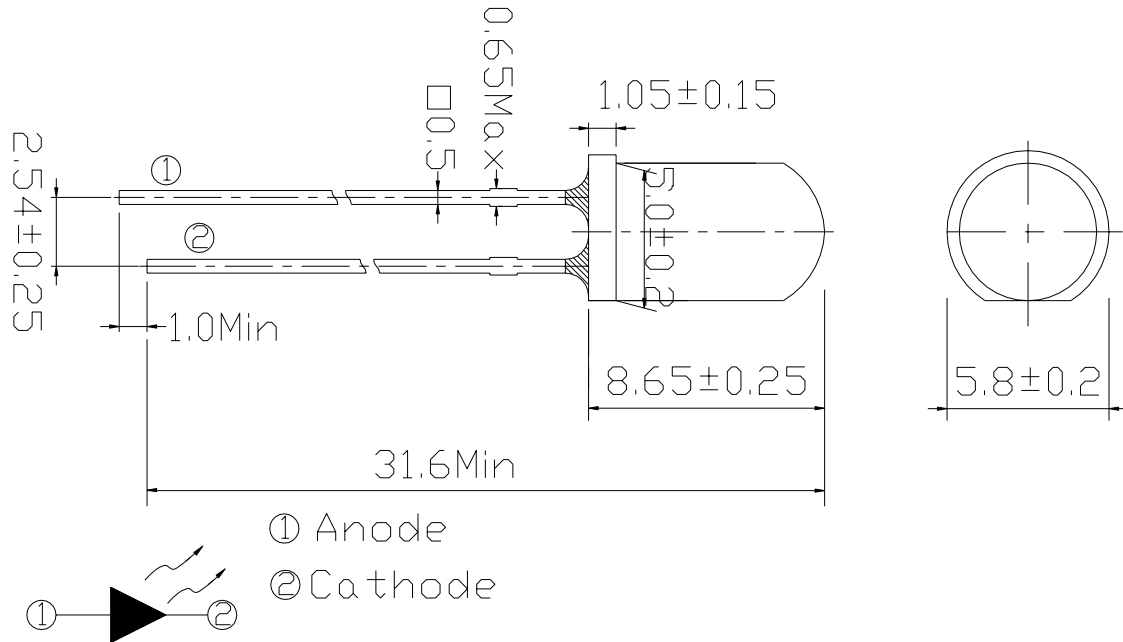

**Notes:**

- All dimensions are in millimeters, tolerance is 0.25mm except being specified.
- Lead spacing is measured where the lead emerges from the package.
- Protruded resin under flange is 1.5mm Max LED.

**Absolute Maximum Ratings (Ta=25°C)**

Parameter	Symbol	Rating	Units
Forward Current	I <sub>F</sub>	25	mA
Pulse Forward Current (Duty 1/10@ 1KHz)	I <sub>FP</sub>	60	mA
Operating Temperature	T <sub>opr</sub>	-40 ~ +85	°C
Storage Temperature	T <sub>stg</sub>	-40 ~ +100	°C
Electrostatic Discharge	ESD	2000	V
Soldering Temperature	T <sub>sol</sub>	260 ±5	°C
Power Dissipation	P <sub>d</sub>	60	mW
Reverse Voltage	V <sub>R</sub>	5	V

Notes: Soldering time ≤ 5 seconds.

**Electro-Optical Characteristics (Ta=25°C)**

Parameter	Symbol	Chip Rank	Min.	Typ.	Max.	Unit	Condition
Luminous Intensity	I <sub>v</sub>	A3	400	630	-----	mcd	I <sub>F</sub> =20mA
		A4	500	800	-----		
		A5	630	1000	-----		
Viewing Angle	2θ <sub>1/2</sub>	-----	-----	30	-----	deg	
Peak Wavelength	λ <sub>p</sub>	-----	-----	632	-----	nm	
Dominant Wavelength	λ <sub>d</sub>	-----	-----	624	-----	nm	
Spectrum Radiation Bandwidth	Δλ	-----	-----	20	-----	nm	
Forward Voltage	V <sub>F</sub>	-----	-----	2.0	2.4	V	
Reverse Current	I <sub>R</sub>	-----	-----	-----	10	μA	V <sub>R</sub> =5V

**7343-2SURC/H2/S530-AX**



**Typical Electro-Optical Characteristics Curves**

**Relative Intensity vs. Wavelength**

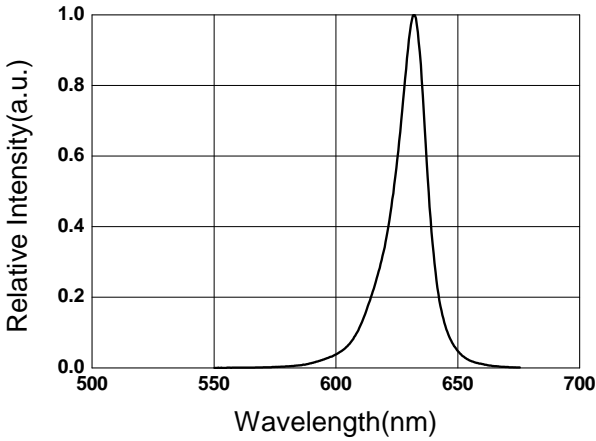

**Forward Current vs. Forward Voltage**

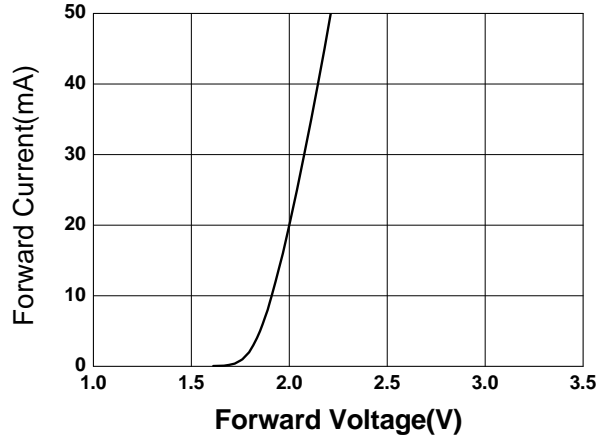

**Relative Intensity vs. Ambient Temp**

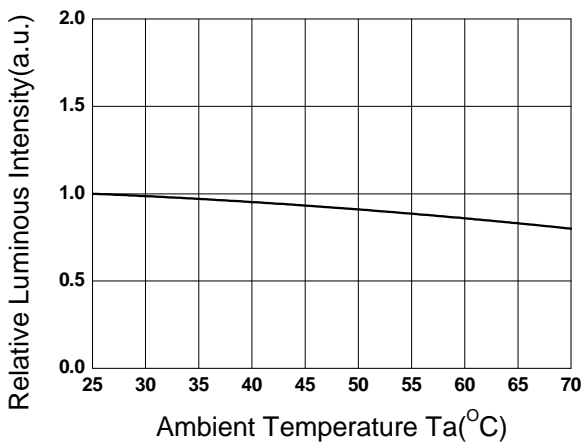

**Forward Current vs. Relative Intensity**

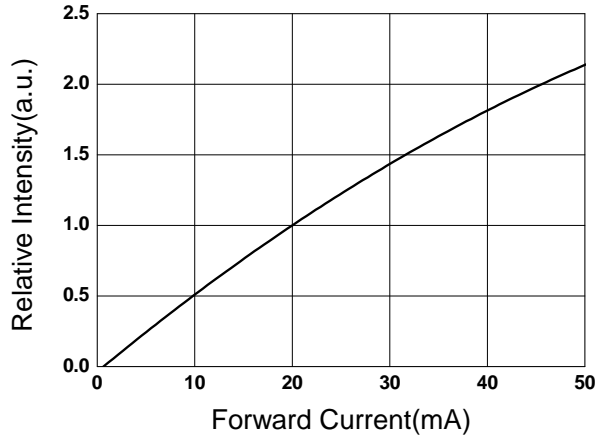

**Forward Current vs. Ambient Temp.**

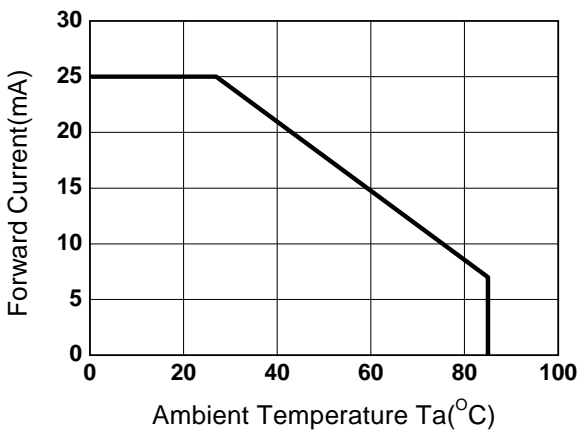

**Radiation Characteristics**

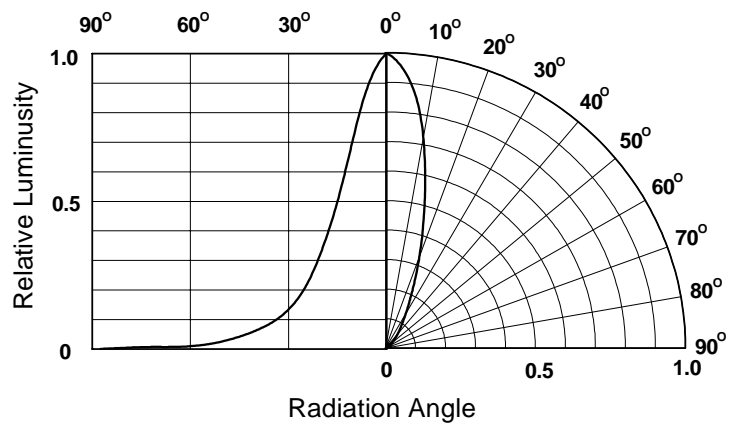



## 7343-2SURC/H2/S530-AX

### Packing Quantity Specification

1. 500 PCS/1 Anti ESD Bag
2. 5 Anti ESD Bags /1 Box
3. 10 Boxes/1 Carton

### Label Form Specification

<b>EVERLIGHT</b>	
CPN:	
P/N:	
7343-2SURC/H2/S530-AX	
QTY :	CAT:
LOT NO :	HUE:
MADE IN TAIWAN	

CPN: Customer's Production Number  
P/N : Production Number  
7343-2SURC/H2/S530-AX:Production name  
QTY: Packing Quantity  
CAT: Ranks of Luminous and Forward Voltage  
HUE: Ranks of Dominant Wavelength  
REF: Reference  
LOT No: Lot Number  
MADE IN TAIWAN: Production Place

### Notes

1. Above specification may be changed without notice. EVERLIGHT will reserve authority on material change for above specification.
2. When using this product, please observe the absolute maximum ratings and the instructions for using outlined in these specification sheets. EVERLIGHT assumes no responsibility for any damage resulting from use of the product which does not comply with the absolute maximum ratings and the instructions included in these specification sheets.
3. These specification sheets include materials protected under copyright of EVERLIGHT corporation. Please don't reproduce or cause anyone to reproduce them without EVERLIGHT's consent.

**EVERLIGHT ELECTRONICS CO., LTD.**  
Office: No 25, Lane 76, Sec 3, Chung Yang Rd,  
Tucheng, Taipei 236, Taiwan, R.O.C

Tel: 886-2-2267-2000, 2267-9936  
Fax: 886-2267-6244, 2267-6189, 2267-6306  
<http://www.everlight.com>