



**User Manual**

# **SOM-5897**

## **COM Express Basic Module**

**ADVANTECH**

*Enabling an Intelligent Planet*

---

## Copyright

The documentation and the software included with this product are copyrighted 2018 by Advantech Co., Ltd. All rights are reserved. Advantech Co., Ltd. reserves the right to make improvements in the products described in this manual at any time without notice. No part of this manual may be reproduced, copied, translated or transmitted in any form or by any means without the prior written permission of Advantech Co., Ltd. Information provided in this manual is intended to be accurate and reliable. However, Advantech Co., Ltd. assumes no responsibility for its use, nor for any infringements of the rights of third parties, which may result from its use.

## Acknowledgements

Intel is a trademark of Intel Corporation.

Microsoft Windows and MS-DOS are registered trademarks of Microsoft Corp.

All other product names or trademarks are properties of their respective owners.

## Product Warranty (2 years)

Advantech warrants to you, the original purchaser, that each of its products will be free from defects in materials and workmanship for two years from the date of purchase.

This warranty does not apply to any products which have been repaired or altered by persons other than repair personnel authorized by Advantech, or which have been subject to misuse, abuse, accident or improper installation. Advantech assumes no liability under the terms of this warranty as a consequence of such events.

Because of Advantech's high quality-control standards and rigorous testing, most of our customers never need to use our repair service. If an Advantech product is defective, it will be repaired or replaced at no charge during the warranty period. For out-of-warranty repairs, you will be billed according to the cost of replacement materials, service time and freight. Please consult your dealer for more details.

If you think you have a defective product, follow these steps:

1. Collect all the information about the problem encountered. (For example, CPU speed, Advantech products used, other hardware and software used, etc.) Note anything abnormal and list any onscreen messages you get when the problem occurs.
2. Call your dealer and describe the problem. Please have your manual, product, and any helpful information readily available.
3. If your product is diagnosed as defective, obtain an RMA (return merchandise authorization) number from your dealer. This allows us to process your return more quickly.
4. Carefully pack the defective product, a fully-completed Repair and Replacement Order Card and a photocopy proof of purchase date (such as your sales receipt) in a shippable container. A product returned without proof of the purchase date is not eligible for warranty service.
5. Write the RMA number visibly on the outside of the package and ship it prepaid to your dealer.

# Declaration of Conformity

## CE

This product has passed the CE test for environmental specifications. Test conditions for passing included the equipment being operated within an industrial enclosure. In order to protect the product from being damaged by ESD (Electrostatic Discharge) and EMI leakage, we strongly recommend the use of CE-compliant industrial enclosure products.

## FCC Class B

Note: This equipment has been tested and found to comply with the limits for a Class B digital device, pursuant to part 15 of the FCC Rules. These limits are designed to provide reasonable protection against harmful interference in a residential installation. This equipment generates, uses and can radiate radio frequency energy and, if not installed and used in accordance with the instructions, may cause harmful interference to radio communications. However, there is no guarantee that interference will not occur in a particular installation. If this equipment does cause harmful interference to radio or television reception, which can be determined by turning the equipment off and on, the user is encouraged to try to correct the interference by one or more of the following measures:

- Reorient or relocate the receiving antenna.
- Increase the separation between the equipment and receiver.
- Connect the equipment into an outlet on a circuit different from that to which the receiver is connected.
- Consult the dealer or an experienced radio/TV technician for help.

## FM

This equipment has passed the FM certification. According to the National Fire Protection Association, work sites are classified into different classes, divisions and groups, based on hazard considerations. This equipment is compliant with the specifications of Class I, Division 2, Groups A, B, C and D indoor hazards.

## Technical Support and Assistance

1. Visit the Advantech website at <http://support.advantech.com> where you can find the latest information about the product.
2. Contact your distributor, sales representative, or Advantech's customer service center for technical support if you need additional assistance. Please have the following information ready before you call:
  - Product name and serial number
  - Description of your peripheral attachments
  - Description of your software (operating system, version, application software, etc.)
  - A complete description of the problem
  - The exact wording of any error messages

---

## Warnings, Cautions and Notes

**Warning!** Warnings indicate conditions, which if not observed, can cause personal injury!



**Caution!** Cautions are included to help you avoid damaging hardware or losing data. e.g.



*There is a danger of a new battery exploding if it is incorrectly installed. Do not attempt to recharge, force open, or heat the battery. Replace the battery only with the same or equivalent type recommended by the manufacturer. Discard used batteries according to the manufacturer's instructions.*

**Note!** Notes provide optional additional information.



## Document Feedback

To assist us in making improvements to this manual, we would welcome comments and constructive criticism. Please send all such - in writing to: [support@advantech.com](mailto:support@advantech.com)

## Packing List

Before setting up the system, check that the items listed below are included and in good condition. If any item does not accord with the table, please contact your dealer immediately.

- SOM-5897 CPU module
- 1 x Heatsreader (1960073944N001)

# Safety Instructions

1. Read these safety instructions carefully.
2. Keep this User Manual for later reference.
3. Disconnect this equipment from any AC outlet before cleaning. Use a damp cloth. Do not use liquid or spray detergents for cleaning.
4. For plug-in equipment, the power outlet socket must be located near the equipment and must be easily accessible.
5. Keep this equipment away from humidity.
6. Put this equipment on a reliable surface during installation. Dropping it or letting it fall may cause damage.
7. The openings on the enclosure are for air convection. Protect the equipment from overheating. **DO NOT COVER THE OPENINGS.**
8. Make sure the voltage of the power source is correct before connecting the equipment to the power outlet.
9. Position the power cord so that people cannot step on it. Do not place anything over the power cord.
10. All cautions and warnings on the equipment should be noted.
11. If the equipment is not used for a long time, disconnect it from the power source to avoid damage by transient overvoltage.
12. Never pour any liquid into an opening. This may cause fire or electrical shock.
13. Never open the equipment. For safety reasons, the equipment should be opened only by qualified service personnel.
14. If one of the following situations arises, get the equipment checked by service personnel:
  - The power cord or plug is damaged.
  - Liquid has penetrated into the equipment.
  - The equipment has been exposed to moisture.
  - The equipment does not work well, or you cannot get it to work according to the user's manual.
  - The equipment has been dropped and damaged.
  - The equipment has obvious signs of breakage.
15. **DO NOT LEAVE THIS EQUIPMENT IN AN ENVIRONMENT WHERE THE STORAGE TEMPERATURE MAY GO BELOW -20° C (-4° F) OR ABOVE 60° C (140° F). THIS COULD DAMAGE THE EQUIPMENT. THE EQUIPMENT SHOULD BE IN A CONTROLLED ENVIRONMENT.**
16. **CAUTION: DANGER OF EXPLOSION IF BATTERY IS INCORRECTLY REPLACED. REPLACE ONLY WITH THE SAME OR EQUIVALENT TYPE RECOMMENDED BY THE MANUFACTURER, DISCARD USED BATTERIES ACCORDING TO THE MANUFACTURER'S INSTRUCTIONS.**

The sound pressure level at the operator's position according to IEC 704-1:1982 is no more than 70 dB (A).

**DISCLAIMER:** This set of instructions is given according to IEC 704-1. Advantech disclaims all responsibility for the accuracy of any statements contained herein.

---

## Safety Precaution - Static Electricity

Follow these simple precautions to protect yourself from harm and the products from damage.

- To avoid electrical shock, always disconnect the power from your PC chassis before you work on it. Don't touch any components on the CPU card or other cards while the PC is on.
- Disconnect power before making any configuration changes. The sudden rush of power as you connect a jumper or install a card may damage sensitive electronic components.

# Contents

<b>Chapter 1</b>	<b>General Information .....</b>	<b>1</b>
1.1	Introduction .....	2
1.2	Specifications .....	2
1.2.1	Board Information .....	2
1.2.2	System Information .....	2
1.2.3	Display .....	3
1.2.4	Expansion Interface .....	3
1.2.5	I/O .....	4
1.2.6	iManager 2.0 .....	4
1.2.7	Mechanical and Environmental Specification .....	4
1.3	Functional Block Diagram .....	5
<b>Chapter 2</b>	<b>Mechanical Information .....</b>	<b>7</b>
2.1	Board Information.....	8
	Figure 2.1 Board Chips Identify - Front.....	8
	Figure 2.2 Board Chips Identify - Back .....	8
2.2	Mechanical Drawing.....	9
	Figure 2.3 Board Mechanical Drawing - Front .....	9
	Figure 2.4 Board Mechanical Drawing - Back .....	9
2.3	Assembly Drawing .....	10
	Figure 2.5 Assembly Drawing (Reference Only) .....	10
<b>Chapter 3</b>	<b>BIOS Operation .....</b>	<b>11</b>
3.1	Starting .....	12
3.1.1	Main Setup .....	13
3.1.2	Advanced BIOS Features Setup.....	14
3.1.3	Chipset.....	37
3.1.4	Security .....	48
3.1.5	Boot Settings.....	49
3.1.6	Save & Exit .....	50
<b>Chapter 4</b>	<b>S/W Introduction &amp; Installation .....</b>	<b>51</b>
4.1	S/W Introduction.....	52
4.2	Driver Installation .....	52
4.2.1	Windows Driver Setup .....	52
4.2.2	Other OS.....	52
4.3	Advantech iManager .....	53
<b>Appendix A</b>	<b>Pin Assignment .....</b>	<b>55</b>
A.1	SOM-5897 Type 6 Pin Assignment.....	56
<b>Appendix B</b>	<b>Watchdog Timer .....</b>	<b>61</b>
B.1	Programming the Watchdog Timer .....	62

---

<b>Appendix C</b>	<b>Programming GPIO.....</b>	<b>63</b>
C.1	GPIO Register.....	64
<b>Appendix D</b>	<b>System Assignments.....</b>	<b>65</b>
D.1	System I/O Ports.....	66
	Table D.1: System I/O ports.....	66
D.2	DMA Channel Assignments.....	67
	Table D.2: DMA Channel Assignments.....	67
D.3	Interrupt Assignments.....	67
	Table D.3: Interrupt Assignments.....	67
D.4	1st MB Memory Map.....	68
	Table D.4: 1st MB Memory Map.....	68



# Chapter 1

## General Information

This chapter gives background information on the SOM-5897 CPU Computer on Module.

Sections include:

- Introduction
- Specification
- Functional Block Diagram

## 1.1 Introduction

SOM-5897 is equipped with the Intel® 6th Generation Core™/ Celeron/ Xeon product family, which are manufactured on 14nm process technology. SOM-5897 ECC/ non-ECC memory supports DDR4 2133MT/s with 1.2V power design, and up to 32GB of dual channel. SOM-5897 not only supports higher memory bandwidth, but also has 33% better battery life than previous generations. SOM-5897 is able to support 8 x PCIe x1 as well as x4, x8 configurations if requested. Most important of all, SOM-5897 adopts a 28mm low profile cooler with a TDP of 45watt at 60°C ambient temperature (optional accessory). SOM-5897 is suitable for rich I/O applications with high performance requirements, such as ultra sound, military, broadcasting, and industrial automation fields.

Compared with previous generations there is 30% improvement in processor performance and up to 50% better 3D graphics. It supports Qual/ Dual core CPU with GT4e/ GT2, DX12, OpenGL 4.4, and OpenCL 2.0 functions. In addition, multiple displays are supported such as dual or triple displays. HDMI/DisplayPort with 4K2K resolution and dual channel LVDS and 16 simultaneous channels at 1920 x1080 full HD resolution are also available.

Advantech iManager was designed to satisfy a lot of embedded application requirements for monitoring and management of voltage and temperatures, thermal protection through processor throttling, LCD backlight on/off and brightness control and more. Combined with Advantech SUSI Access, it can remotely monitor and control devices through the internet for easy maintenance and configuration. All Advantech COM Express modules integrate iManager and SUSI Access.

SOM-5897 is suitable for computing intensive designs, thermally sensitive applications, graphics/media sensitive designs, and I/O demanding applications.

## 1.2 Specifications

### 1.2.1 Board Information

- **Pin Definition:** PICMG COM.0 R2.1 Type 6 pin-out definition.
- **Form Factor:** PICMG COM.0 R2.1 basic module 125 x 95 mm.

### 1.2.2 System Information

- **CPU:** 6<sup>th</sup> Gen Intel® Core Processors.

CPU	Standard Freq.	Max. Turbo Freq.	Core	Cache (MB)	TDP(W)
i7-6820EQ	2.8GHz	3.5GHz	4	8	45
I7-6822EQ	2.0GHz	2.8GHz	4	8	25
i5-6440EQ	2.7GHz	3.4GHz	4	6	45
i5-6442EQ	1.9GHz	2.7GHz	4	6	25
i3-6100E	2.7GHz	NA	2	3	35
i3-6102E	1.9GHz	NA	2	3	25
G3900E	2.4GHz	NA	2	2	35
E3-1505M V5	2.8GHz	3.7GHz	4	8	45
E3-1505L V5	2.0GHz	2.8GHz	4	8	25
E3-1515M V5	2.8GHz	3.7GHz	4	8	45

- **Memory:** 2 SODIMM socket for DDR4 2133, up to 32GB.
- **BIOS:** AMI UEFI.

- **Power management:** Supports power saving modes including Normal / Standby / Suspend modes. ACPI 2.0 compliant.

### 1.2.3 Display

- **Graphic Core:** Intel® Gen9 HD/P530/P580 graphics supports DX12, OGL4.4, OCL2.0, and MPEG2, HEVC/H265, VC1/WMV9 HW decode/encode/transcode acceleration.

CPU	Graphics Core	Base Freq.	Max Freq.
i7-6820EQ	Gen9 HD Graphic	350MHz	1000MHz
I7-6822EQ	Gen9 HD Graphic	350MHz	1000MHz
i5-6440EQ	Gen9 HD Graphic	350MHz	1000MHz
i5-6442EQ	Gen9 HD Graphic	350MHz	1000MHz
i3-6100E	Gen9 HD Graphic	350MHz	950MHz
i3-6102E	Gen9 HD Graphic	350MHz	950MHz
G3900E	Gen9 HD Graphic	350MHz	950MHz
E3-1505M V5	HD Graphic P530	350MHz	1050MHz
E3-1505L V5	HD Graphic P530	350MHz	1000MHz
E3-1515M V5	HD Graphic P580	350MHz	1000MHz

- **VGA:** Resolution up to 1920 x 1200.
- **LVDS:** Supports single/dual channel 18/24-bit, resolution up to 1920 x 1200 @ 60 Hz.
- **HDMI/DVI/DP:** Supports 3 ports HDMI (default), DVI, or DP multiplexed.  
Resolution: HDMI up to 4096 x 2160 @24Hz  
DVI up to 1920 x 1080 @ 60 Hz  
DP up to 4096 x 2304@60Hz 24bpp
- **Dual Display:**
  - VGA + LVDS,
  - VGA + HDMI/DVI/DP,
  - LVDS + HDMI/DVI/DP,
  - HDMI/DVI/DP + HDMI/DVI/DP
- **Triple Display:**
  - LVDS + DP + DP/HDMI,
  - LVDS + DP + VGA,
  - LVDS + HDMI + HDMI,
  - DP + DP + DP,
  - DP + HDMI +HDMI,
  - DVI + DP + HDMI,
  - VGA + DP + HDMI

### 1.2.4 Expansion Interface

- **PCI Express x1:** Supports default 8 PCIe x1 compliant ports to PCIe Gen3 (8.0 GT/s) specification; optionally configurable to PCIe x4 or PCIe x2. Several configurable combinations may need BIOS modification. Please contact Advantech sales or FAE for more details.
- **Audio Interface:** Intel HD Audio interface

- **LPC Bus:** Supports Low Pin Count (LPC) 1.1 specification, without DMA or bus mastering. Allows connection to Super I/O, embedded controller, or TPM. LPC clock is 25MHz.
- **SMBus:** Supports SMBus 2.0 specification with alert pin.
- **I2C Bus:** Up to 400KHz.
- **SPI:** Supports SPI BIOS only.

### 1.2.5 I/O

- **Ethernet:** Intel I219LM Gigabit LAN supports 10/100/1000 Mbps Speed
- **SATA:** Supports 4 ports SATA Gen3 (600 Gb/s)
- **USB Interface:** Supports 4 ports USB3.0, 8 ports USB 2.0
- **Serial Port:** Supports 2 ports 2-wire serial port
- **Express Card:** 2 ports
- **Panel Control:** Supports panel backlight on/off control, brightness control
- **Thermal Protection:** Supports thermal shutdown or CPU throttling
- **Watchdog Timer:** 65536 level timer interval, from 0~65535 sec, multi-level, multi-option watchdog timer
- **Smart Fan:** 1 port on module, 1 port down to carrier board
- **GPIO:** 8-bit GPIO
- **Hardware Monitor:** Vin, 5VSB, CMOS
- **TPM:** BOM option, default not available

### 1.2.6 iManager 2.0

Refer to section 4.3.

### 1.2.7 Mechanical and Environmental Specification

- **Dimensions:** 125 x 95 mm (4.92" x 3.74")
- **Power Type and Supply Voltage:**
  - ATX: +8.5~20V and +4.75~5.25VSB (standby power)
  - AT: +8.5~20V
  - CMOS Battery: +3.3V
- **Power Requirements:**
  - Test condition: SOM-5897C3-U3A1E (i3-6100U), DDR3L-1600 16GB, WIN8.1 64-bit, under 12V and 5VSB input power supply.
  - Idle: 8.5W
  - Max: 41.8W (Burn-in V6.0 Pro)
- **Temperature Specification:**
  - Operating: 0 ~ 60° C (32 ~ 140° F)
  - Storage: -40 ~ 85° C (-40 ~ 185° F)
- **Humidity Specification:**
  - Operating: 40° C @ 95% relative humidity, non-condensing
  - Storage: 60° C @ 95% relative humidity, non-condensing





# Chapter 2

## Mechanical Information

This chapter gives mechanical information on the SOM-5897 CPU Computer on Module.

Sections include:

- Board Information
- Mechanical Drawing
- Assembly Drawing

## 2.1 Board Information

The figures below indicate the main chips on SOM-5897 Computer-on-Module. Please be aware of these positions while designing your own carrier board to avoid mechanical issues, as well as designing thermal solution contact points for best thermal dissipation performance.

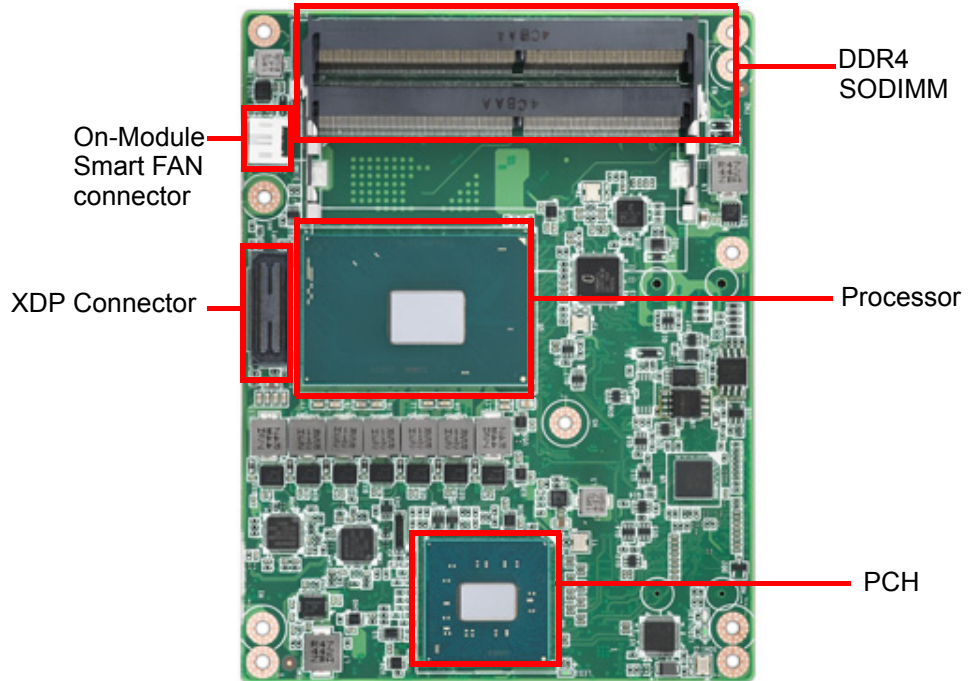

Figure 2.1 Board Chips Identify - Front

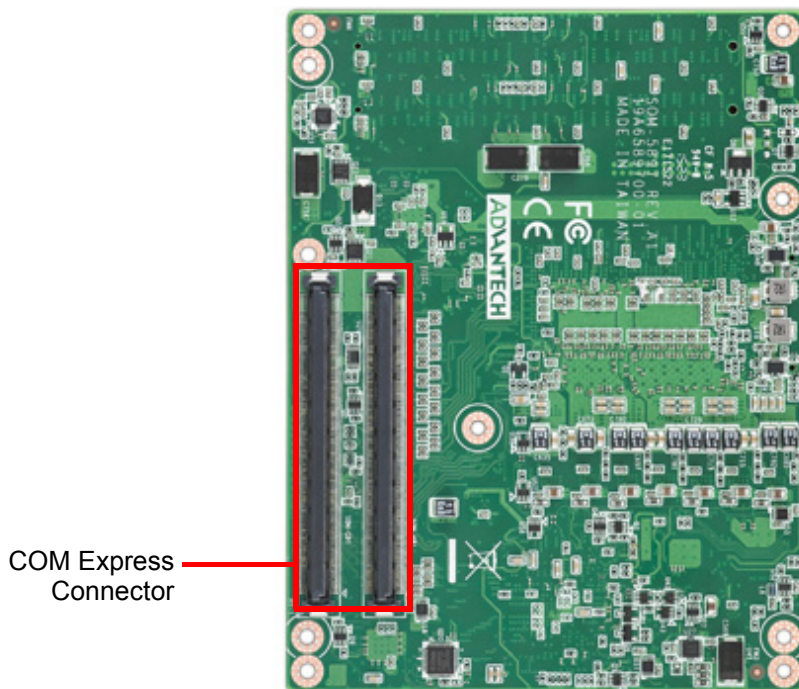
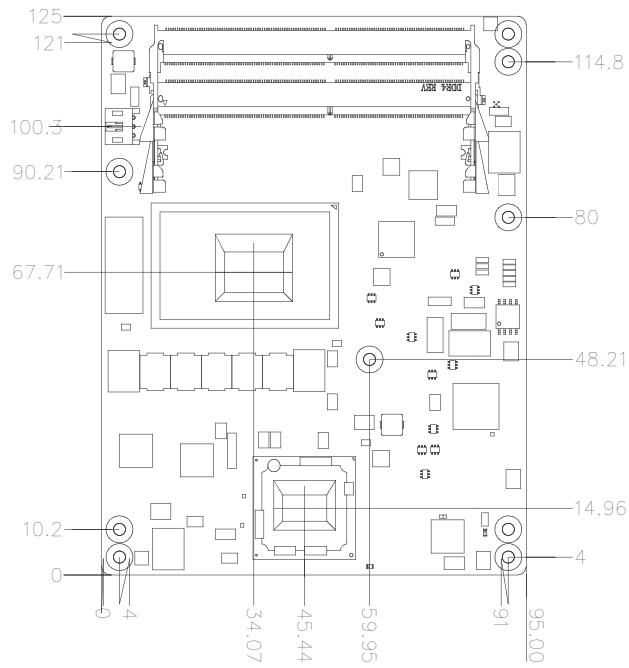

Figure 2.2 Board Chips Identify - Back



## 2.2 Mechanical Drawing

For more details about 2D/3D models, please look on the Advantech COM support service website <http://com.advantech.com>.



**Figure 2.3 Board Mechanical Drawing - Front**

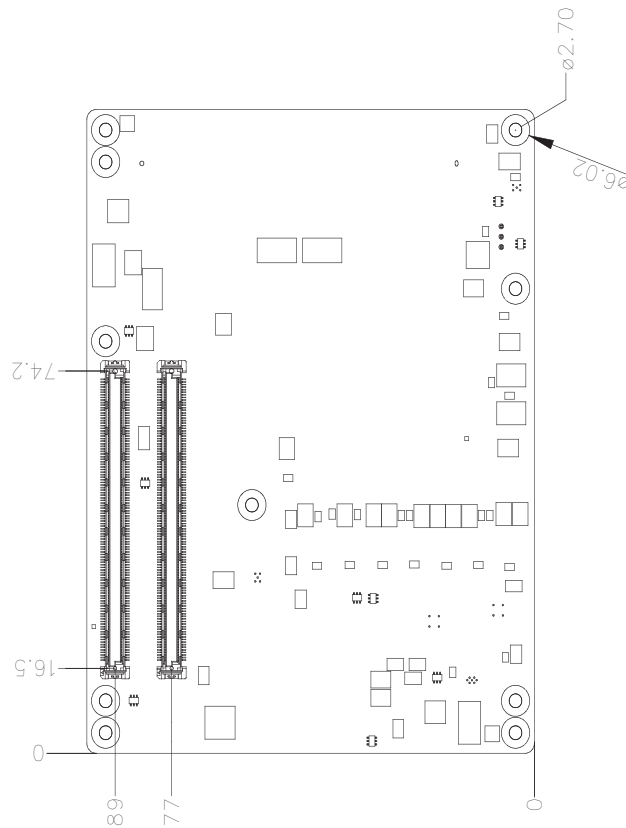

**Figure 2.4 Board Mechanical Drawing - Back**

## 2.3 Assembly Drawing

Assembly order for the thermal module and COM module onto the carrier board.

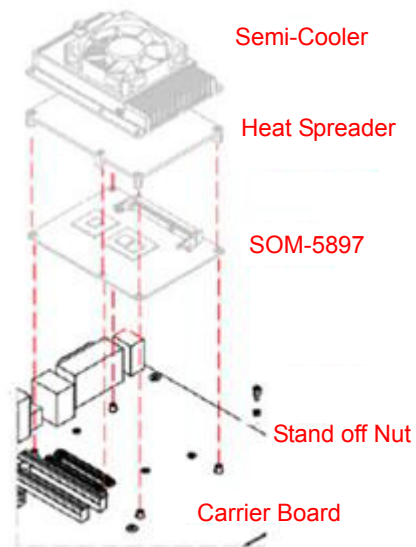

**Figure 2.5 Assembly Drawing (Reference Only)**

There are 3 reserved screw holes for SOM-5897 to be pre-assembled with the heat spreader.

# Chapter 3

## BIOS Operation

This chapter gives BIOS setup information for the SOM-5897 CPU Computer on Module.

Sections include:

- Introduction
- Entering Setup
- Hot / Operation Key
- Exit BIOS Setup Utility

## 3.1 Starting

**SOM-5897** BIOS has been stored into a flash ROM which is inserted into a BIOS socket on the board. With the BIOS Setup program, users can modify BIOS settings and control various system features. This chapter describes the basic navigation of the **SOM-5897** BIOS setup screens.

Advantech will have revisions for product optimization so customers can re-flash the latest BIOS through the AFU utility. Please contact Advantech sales or FAE for more details.

### Entering the BIOS

To enter the BIOS setup screens, follow the steps below:

1. Power on the motherboard.
2. Press the **Delete** or **Esc** key on your keyboard when you see the following text prompt: Press **Delete** or **Esc** to enter setup.
3. After you press the **Delete** key, the main BIOS setup menu displays. You can access the other BIOS function settings.



The BIOS setup screen has three main frames. The left frame displays all information and configurable items. Grayed-out text is information only. Blue items are options that can be configured. White one is the current focus item to be selected.

The right-upper frame is an area reserved for a text message. When an option is selected from the left frame, a help text message will show at this area.

The following table shows the hot keys operation guide.

Hot Key	Description
→ Right ← Left	The Left and Right < > keys allow you to select a BIOS setup page. For example: Main page, Advanced page, Chipset page, and so on.
↑ Up ↓ Down	The Up and Down < > keys allow you to select a BIOS setup item or sub-screen.
+ - Plus/Minus	The Plus and Minus keys allow you to change the field value of a particular setup item. For example: Date and Time.
F1	The <F1> key allows you to display the General Help screen. Press the <F1> key to open the General Help screen.
F2	Load Previous Values. Ignore modified configures.
F3	Load Optimized Defaults.
F4	Save configuration and exit.
ESC	The <Esc> key allows you to go back to upper menu item. At root page, <Esc> key is used for Quit without saving.
Enter	Entering submenu or display option items.

**SOM-5897** BIOS has a built-in Setup program that allows users to modify the basic system configuration. This information is stored in flash ROM so it retains the Setup information when the power is turned off.

### 3.1.1 Main Setup

When users first enter the BIOS Setup Utility, they will enter the **Main** setup screen. You can always return to the Main setup screen by selecting the **Main** tab. The Main BIOS Setup screen is shown below.



The Main page shows BIOS Information

Feature	Options	Description
BIOS Information	No option	Subtitle
BIOS Vendor	No option	Displays the BIOS vendor, where we suppliers license from.
Core Version	No option	Displays the BIOS vendor's kernel core version.
Compliance	No option	Displays this BIOS supporting industry standards compliance.
Project Version	No option	Displays the project version of Advantech projects.
Build Date and Time	No option	Displays this BIOS build date and time.
Access Level	No option	Please refers to session "3.1.4 Security".
System Language	English	Choose the BIOS language
System Date	mm/dd/yyyy	Set the system date. Use Tab to switch between Date elements. Use + / - or numbers to change the value.
System Time	hh:mm:ss	Set the system time. Use Tab to switch between Date elements. Use + / - or numbers to change the value.

### 3.1.2 Advanced BIOS Features Setup

Select the Advanced tab from the **SOM-5897** setup screen to enter the Advanced BIOS Setup screen. Users can select any item in the left frame of the screen, such as CPU Configuration, to go to the sub menu for that item. Users can display an Advanced BIOS Setup option by highlighting it using the <Arrow> keys. All Advanced BIOS Setup options are described in this section. The Advanced BIOS Setup screens are shown below. The sub menus are described on the following pages.

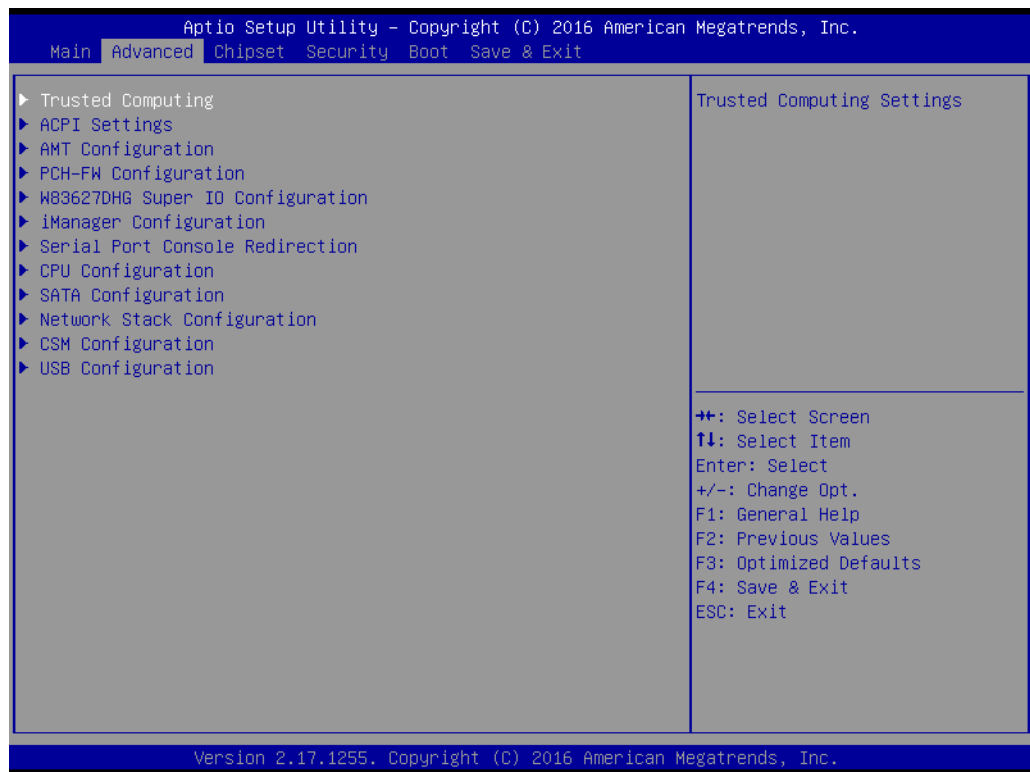

### 3.1.2.1 Trusted Computing



Trusted Computing is a technology developed and promoted by the Trusted Computing Group. With Trusted Computing, the computer will consistently behave in expected ways, and those behaviors will be enforced by computer hardware and software. Enforcing this behavior is achieved by loading the hardware with a unique encryption key inaccessible to the rest of the system.

#### Security Device Support

This sub-menu will allow you to enable/disable TPM Trusted Platform Module (TPM) support, and to configure the TPM state. Select Trusted Computing and press **Enter** to access the sub-menu. Press **Enter** to access the TPM support menu and select **Enable** to display the full TPM configuration menu.

Feature	Options	Description
Security Device Support	Disable Enable	Enables or disables the BIOS support for TPM (Trusted Platform Module) function.
TPM State	Disable Enable	Enable or Disable security device. Note: Your computer will reboot during restart in order to change State of the Device.
Pending Operation	None TPM Clear	Schedule an operation for the security device. Note: Your computer will reboot during restart in order to change the state of the device.
Device Select	TPM1.2 TPM2.0 Auto	TPM 1.2 will restrict support to TPM 1.2 devices. TPM 2.0 will restrict support to TPM2.0. Auto will support both with the default set to TPM2.0 devices if not found, TPM 1.2 devices will be enumerated.

### 3.1.2.2 ACPI Settings

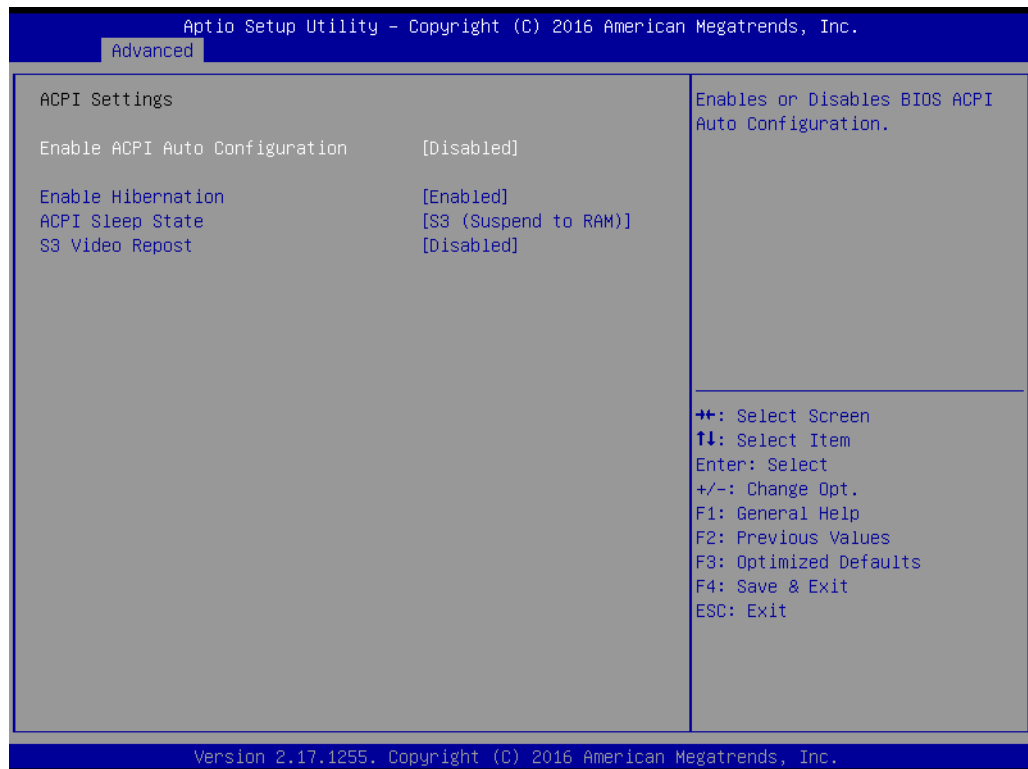

Feature	Options	Description
Enable ACPI Auto Configuration	Disable Enable	Enables or disables BIOS ACPI auto configuration. If this feature is enabled as auto, no more options can be configured.
Enable Hibernation	Disable Enable	Enable or disable system's ability to hibernate (operating system S4 sleep state). Needs OS support for this feature.
ACPI Sleep State	Suspend Disabled S3 (Suspend to RAM)	Select the state used for ACPI system sleep/suspend.
S3 Video Repost	Disable Enable	Enables or disables video BIOS screen when resume from S3 state.

**Note!**  *ACPI (Advanced Configuration and Power Interface) is a Power Management and configuration standard for the PC. ACPI allows the operating system to control the amount of power each device is given (allowing it to put certain devices on standby or power-off for example). It is also used to control and/or check thermal zones (temperature sensors, fan speeds, etc), battery levels, PCI IRQ routing, CPUs, NUMA domains and many other things.*



### 3.1.2.3 AMT Configuration

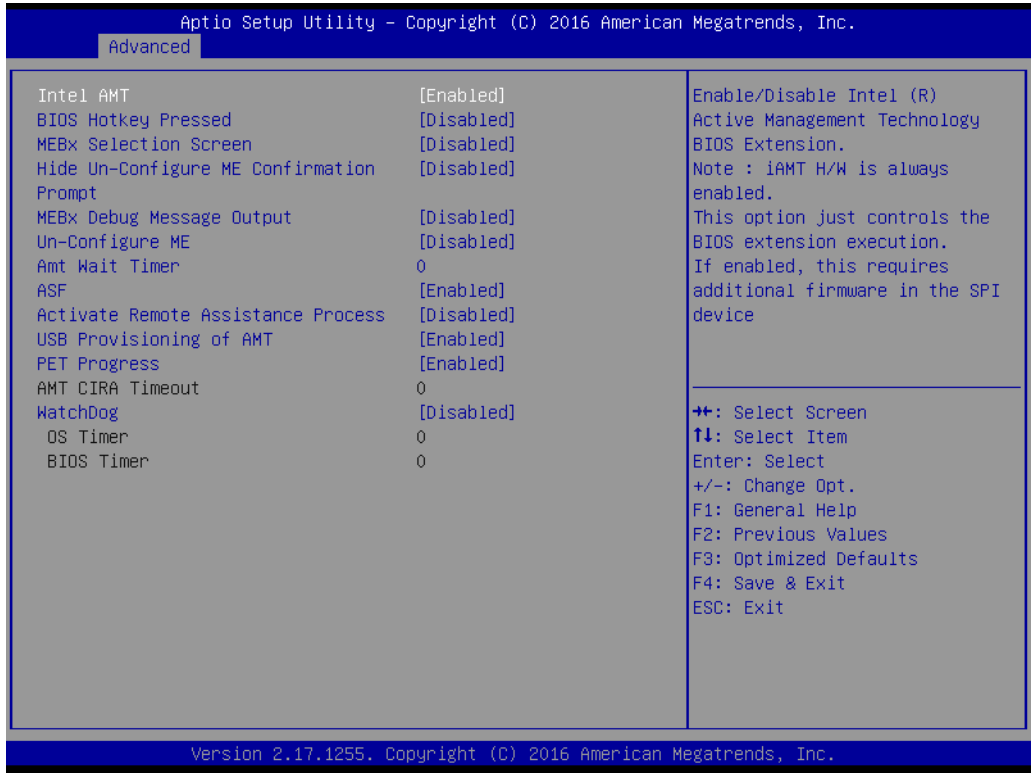

Feature	Options	Description
Intel AMT	Disable Enable	Enable/Disable Intel ® Active Management Technology BIOS Extension. Note: iAMT H/W is always enabled. This option just controls the BIOS extension execution. If enabled, this requires additional firmware in the SPI device.
BIOS Hotkey Pressed	Disable Enable	Enable/Disable BIOS hotkey press. Enable this feature will show hotkey prompt at booting up screen.
MEBx Selection Screen	Disable Enable	Enable/Disable MEBx selection screen at booting up. This feature allows to enter ME configuration screens OR initiate a remote connection.
Hide Un-Configure ME Confirmation Prompt	Disable Enable	Hide Un-Configure ME without password Confirmation Prompt
MEBx Debug Message Output	Disable Enable	Enable MEBx debug message output. This feature is for debug purpose only.
Un-Configure ME	Disable Enable	Use this item to enable/disable un-configure ME without password.
AMT Wait Timer	0 ~ 65535	Set timer to wait before sending ASF_GET_BOOT_OPTOINS.
ASF	Disable Enable	Use this item to enable/disable Alert Specification Format.
Activate Remote Assistance Process	Disable Enable	Use this item to enable/disable trigger CIRA (Client Initiated Remote Access) boot.
USB Provisioning of AMT	Disable Enable	Enable/Disable of AMT USB Provisioning
PET Progress	Disable Enable	User can Enable/Disable PET Events progress to receive PET events or not

AMT CIRA Timeout	0 ~ 65535	Note: To set this option, you need to enable "Activate Remote Assistance Process"
WatchDog	Disable Enable	Enable/Disable Watchdog Timer.
OS Timer	0 ~ 65535	Set the WatchDog timer for OS
BIOS Timer	0 ~ 65535	Set the WatchDog timer for BIOS

**Note!**



*Intel® Active Management Technology (Intel® AMT) is a feature of Intel® Core™ processors with Intel® vPro™ technology and workstation platforms based on select Intel® Xeon® processors. Intel® AMT uses integrated platform capabilities and popular third-party management and security applications, to allow IT or managed service providers to better discover, repair, and help protect their networked computing assets. Intel® AMT also saves time with remote maintenance and wireless manageability for your mobile workforce, and secure drive wiping to simply PC lifecycle transitions.*

**CIRA:** Intel CIRA enables out-of-band management systems, such as Intel AMT. It is intended to enable centralized corporate management and administration of laptops that are not attached to the corporate LAN, but rather are located off-site (homes, hotels, etc.). Because off-site systems will typically be behind a firewall, there is no way for the corporate administrator to directly find the machine. Thus, instead, the system (the 'client') will initiate a connection to the corporate administration server; the server can then use this connection to admin the machine. The system is implemented in firmware, and is meant to enable administration resources such as Intel AMT and Intel vPro.

**ASF:** Alert Standard Format (ASF) is a DMTF standard for remote monitoring, management and control of computer systems in both OS-present and OS-absent environments. These technologies are primarily focused on minimizing on-site I/T maintenance, maximizing system availability and performance to the local user.

**PET:** Platform Event Traps (PET) transmitted by the Alert Sending Device and received by the Remote Management Console via UDP port 162 (SNMP-Traps)

## 3.1.2.4 PCH-FW Configuration



Feature	Options	Description
ME FW Version	No option	Shows the current ME status
ME Firmware Mode	No option	Shows the current ME status
ME Firmware Type	No option	Shows the current ME status
ME Firmware SKU	No option	Shows the current ME status
PTT Capability / State	No option	Shows the current ME status
NFC Support	No option	Shows the current ME status
ME Unconfig on RTC Clear State	No option	Shows the current ME status
ME State	No option	Shows the current ME status
TPM Device Selection	dTPM 1.2 PTT	Select TPM device: 'PTT' - Enables PTT and disables dTPM in SkuMgr. 'dTPM 1.2' - Enables dTPM 1.2 and disables PTT in SkuMgr. Warning: If you enable PTT, dTPM will be disabled and all data saved on it will be lost. Likewise, if you enable dTPM, PTT will be disabled and all data saved on it will be lost.
Firmware Update Configuration	<Sub Menu>	Configure Management Engine Technology Parameters

**Note!**  *The Management Engine (ME) is an isolated and protected coprocessor, embedded as a non-optional part in all current (as of 2015) Intel chipsets.*

*The ME has its own MAC and IP address for the out-of-band interface, with direct access to the Ethernet controller; one portion of the Ethernet traffic is diverted to the ME even before reaching the host's operating system, for what support exists in various Ethernet controllers, exported and made configurable via Management Component Transport Protocol (MCTP).*



Feature	Options	Description
ME FW Image Re-Flash	Disable Enable	Enable/Disable ME FW Image Re-Flash function

### 3.1.2.5 W83627DHG Super IO Configuration

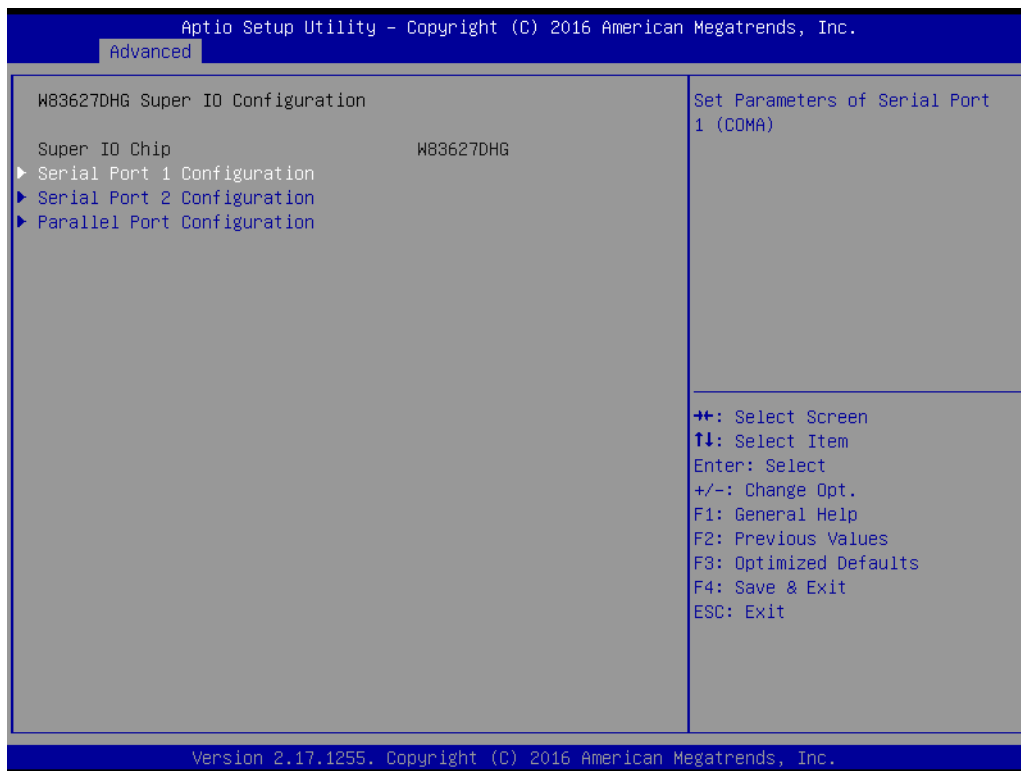

Feature	Options	Description
Super IO Chip	No option	
Serial Port 1 Configuration	<Sub Menu>	Set Parameters of Serial Port 1 (COMA)
Serial Port 2 Configuration	<Sub Menu>	Set Parameters of Serial Port 2 (COMB)
Parallel Port Configuration	<Sub Menu>	Set Parameters of Parallel Port (LPT/LPTE)

## ■ Serial Port 1 Configuration

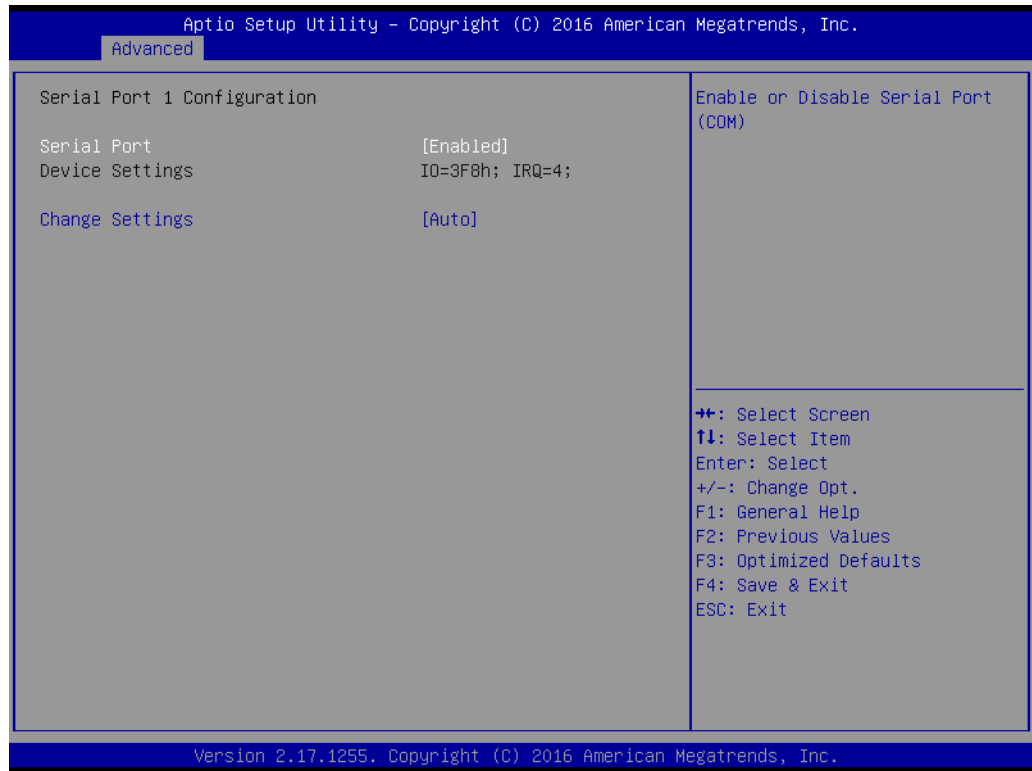

Feature	Options	Description
Serial Port	Disable Enable	Enable or Disable Serial Port (COM)
Device Settings	No option	The current settings
Change Settings	Auto IO=3F8h; IRQ=4; IO=3F8h; IRQ=3,4,5,6,7,9,10,11,12; IO=2F8h; IRQ=3,4,5,6,7,9,10,11,12; IO=3E8h; IRQ=3,4,5,6,7,9,10,11,12; IO=2E8h; IRQ=3,4,5,6,7,9,10,11,12;	

## ■ Serial Port 2 Configuration

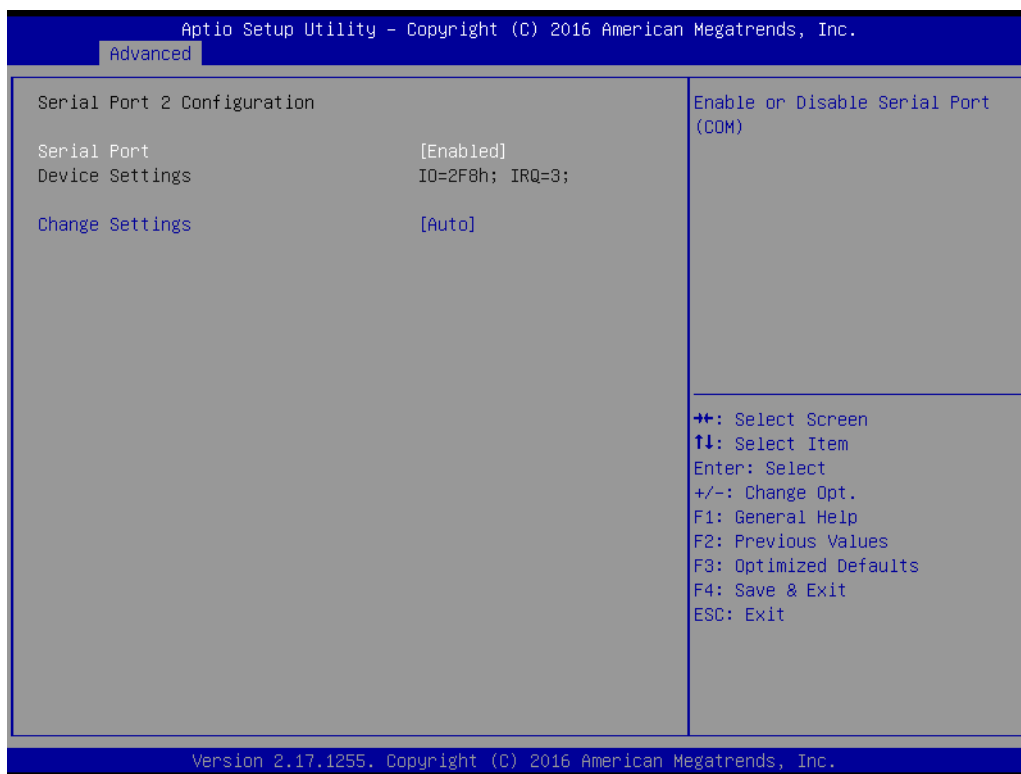

Feature	Options	Description
Serial Port	Disable Enable	Enable or Disable Serial Port (COM)
Device Settings	No option	The current settings
Change Settings	Auto IO=2F8h; IRQ=3; IO=3F8h; IRQ=3,4,5,6,7,9,10,11,12; IO=2F8h; IRQ=3,4,5,6,7,9,10,11,12; IO=3E8h; IRQ=3,4,5,6,7,9,10,11,12; IO=2E8h; IRQ=3,4,5,6,7,9,10,11,12;	

## ■ Parallel Port Configuration

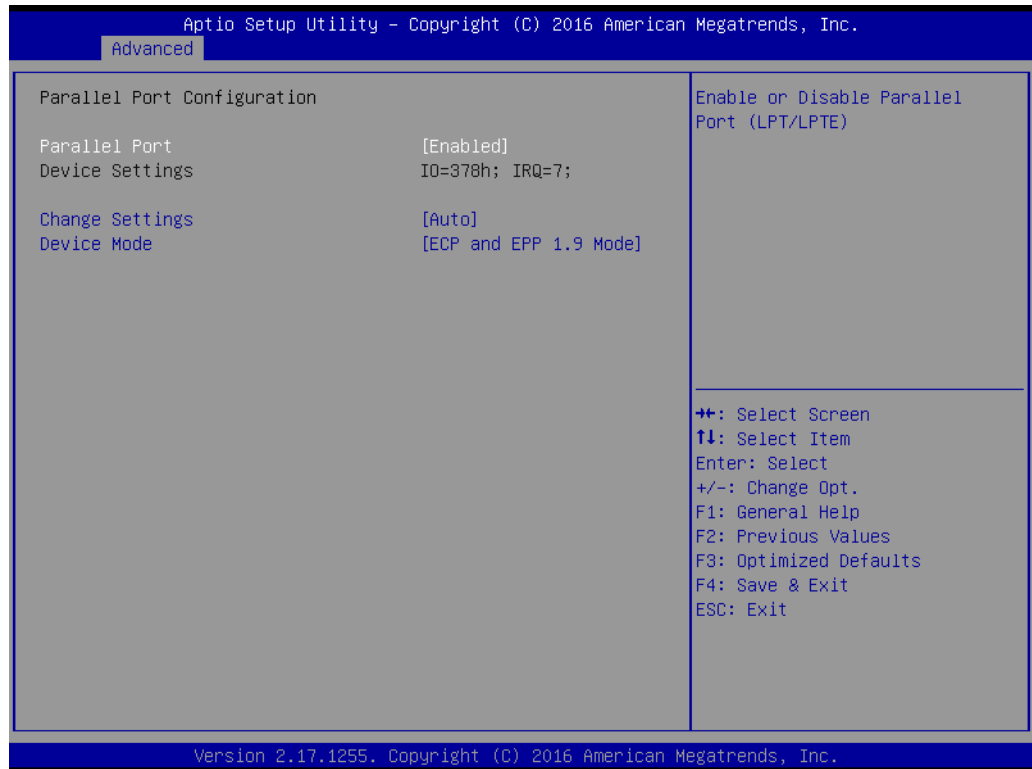

Feature	Options	Description
Parallel Port	Disable Enable	Enable or Disable Serial Port (COM)
Device Settings	No option	The current settings
Change Settings	Auto IO=378h; IRQ=7; DMA=3; IO=378h; IRQ=5,6,7,9,10,11,12; DMA=1,3; IO=278h; IRQ=5,6,7,9,10,11,12; DMA=1,3; IO=3BCh; IRQ=5,6,7,9,10,11,12; DMA=1,3;	
Device Mode	STD Printer Mode EPP-1.9 and SPP Mode ECP and EPP 1.9 Mode	Change the Printer Port mode



### 3.1.2.6 iManager Configuration

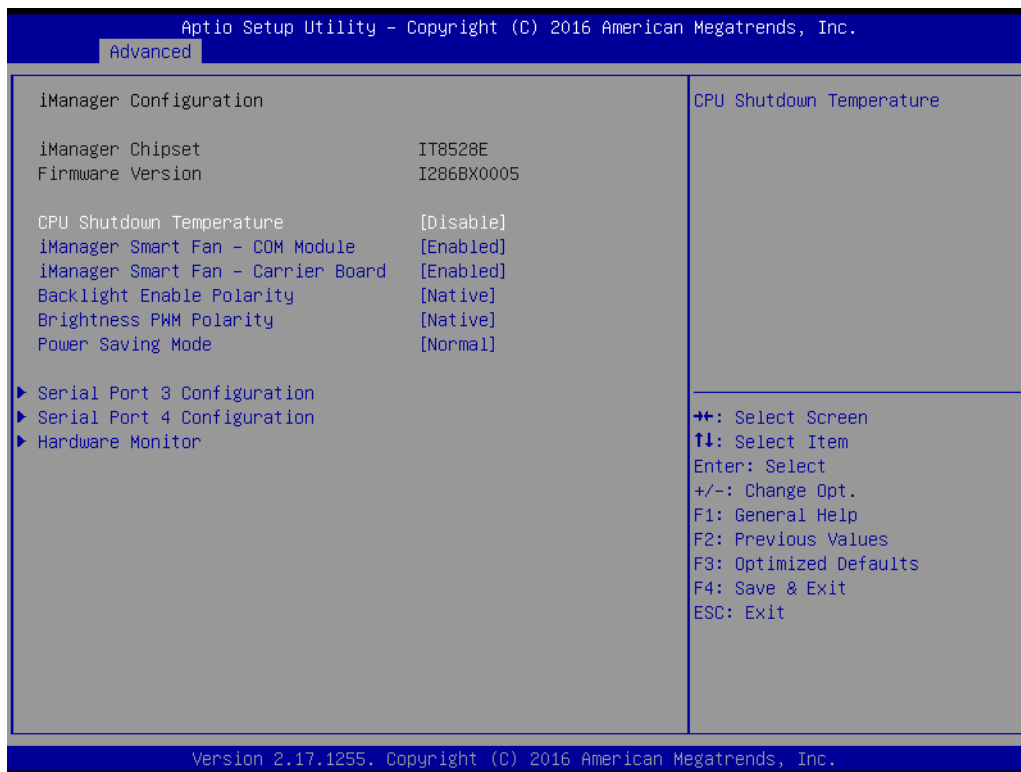

Feature	Options	Description
CPU Shutdown Temperature	Disable	CPU emergency shutdown temperature when over heated.
	70°C / 158°F	
	75°C / 167°F	
	80°C / 176°F	
	85°C / 185°F	
	90°C / 194°F	
	95°C / 203°F	
100°C / 212°F		
iManager Smart Fan - COM Module	Disable Enable	Enables / Disables Smart FAN control on COM module
iManager Smart Fan - Carrier Board	Disable Enable	Enables / Disables Smart FAN control on Carrier Board
Backlight Enable Polarity	Native Invert	Set Backlight Enable Polarity Native or Invert according to LVDS panel.
Brightness PWM Polarity	Native Invert	Set Brightness PWM Polarity Native or Invert according to LVDS panel.
Power Saving Mode	Normal Deep Sleep	Select Power Saving mode as Normal or Deep Sleep.

## ■ Serial Port 3 Configuration

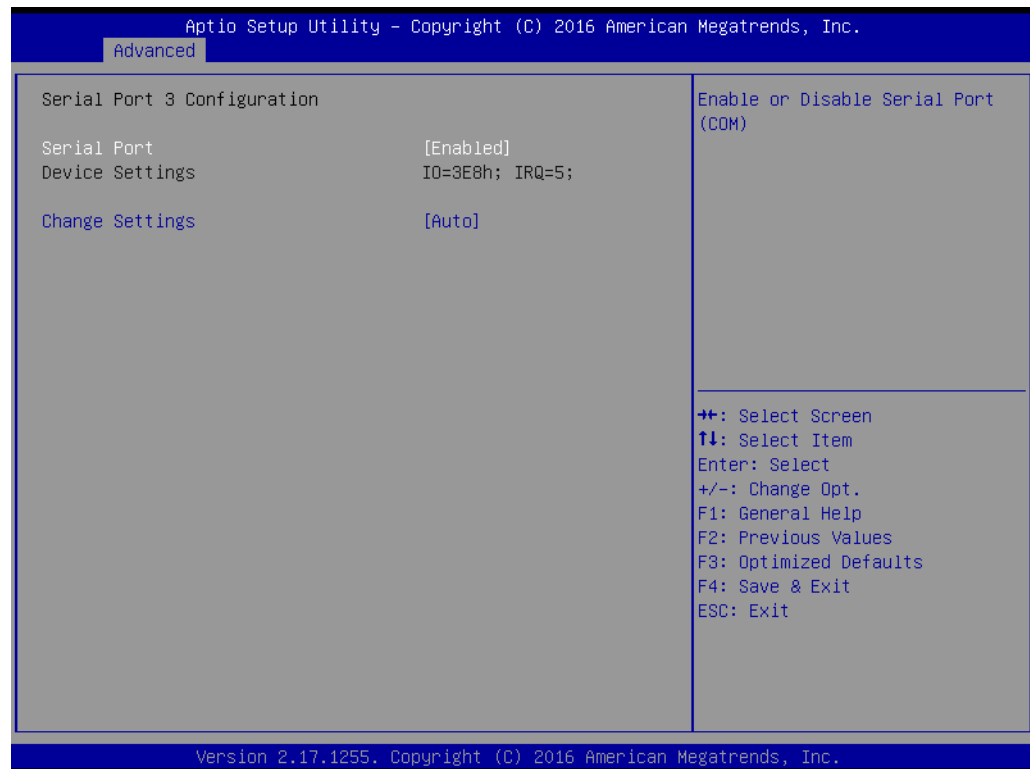

Feature	Options	Description
Serial Port	Disable Enable	Enable or Disable Serial Port (COM)
Device Settings	No option	The current settings
Change Settings	Auto IO=3E8h; IRQ=5; IO=3F8h; IRQ=3,4,5,6,7,11; IO=2F8h; IRQ=3,4,5,6,7,11; IO=3E8h; IRQ=3,4,5,6,7,11; IO=2E8h; IRQ=3,4,5,6,7,11;	

## Serial Port 4 Configuration

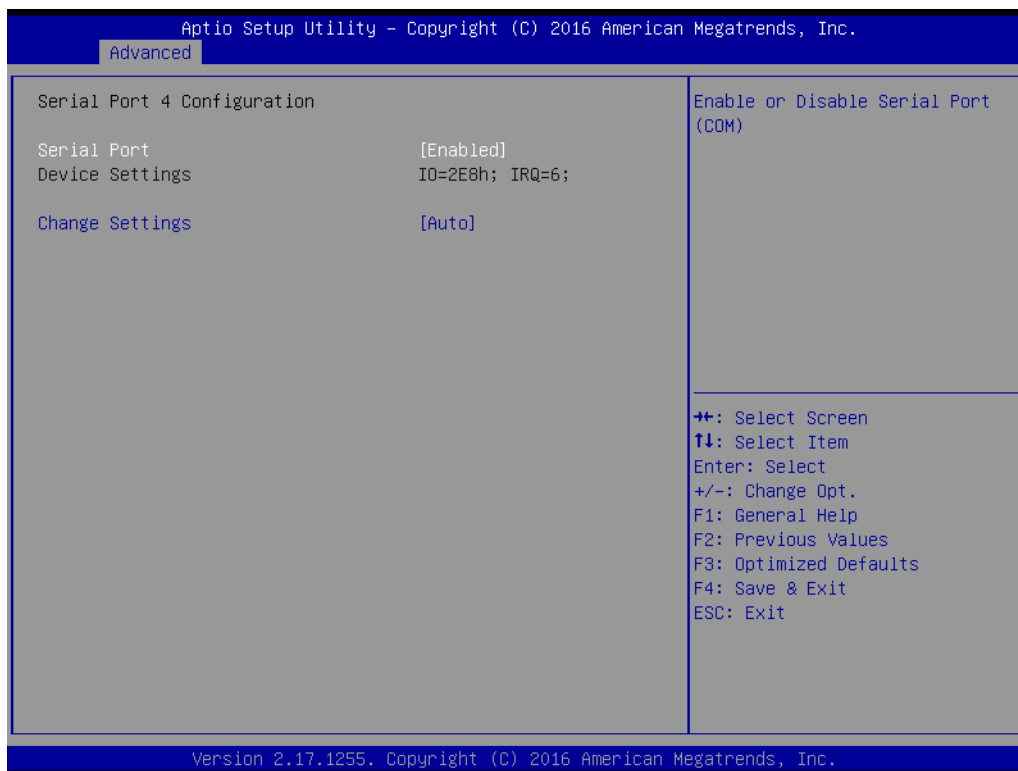

Feature	Options	Description
Serial Port	Disable Enable	Enable or Disable Serial Port (COM)
Device Settings	No option	The current settings
Change Settings	Auto IO=2E8h; IRQ=6; IO=3F8h; IRQ=3,4,5,6,7,11; IO=2F8h; IRQ=3,4,5,6,7,11; IO=3E8h; IRQ=3,4,5,6,7,11; IO=2E8h; IRQ=3,4,5,6,7,11;	

## ■ Hardware Monitor

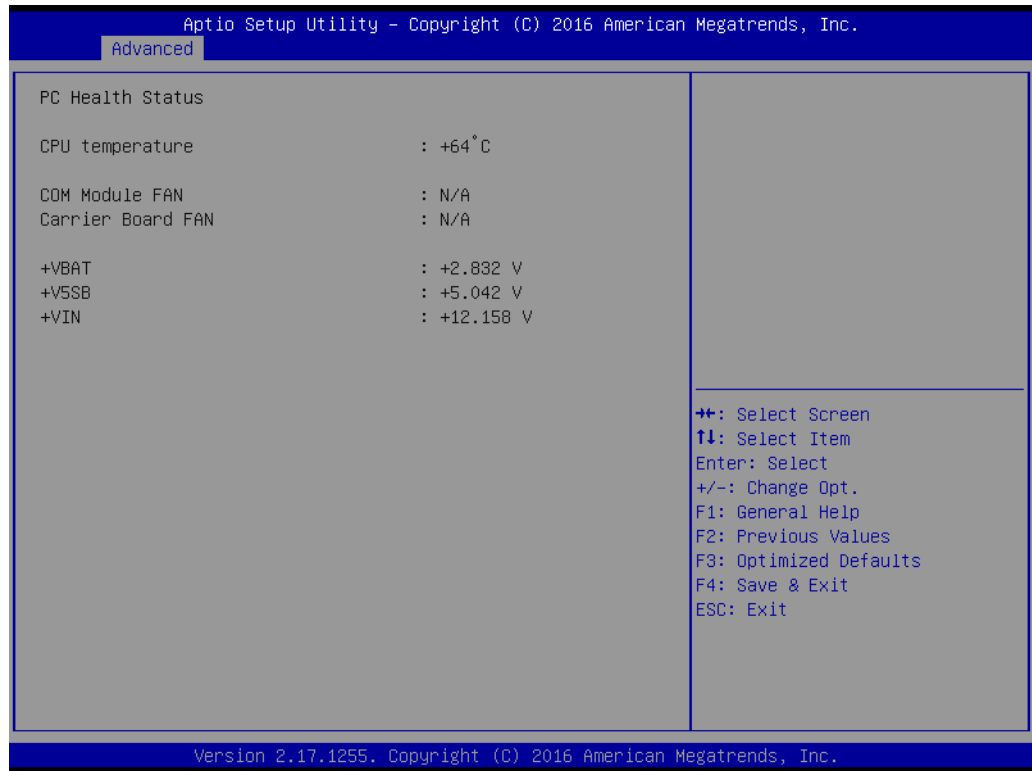

Feature	Options	Description
CPU temperature	No option	Shows the current status
COM Module FAN	No option	Shows the current status
Carrier Board FAN	No option	Shows the current status
+VBAT	No option	Shows the current status
+V5SB	No option	Shows the current status
+VIN	No option	Shows the current status

### 3.1.2.7 Serial Port Console Redirection

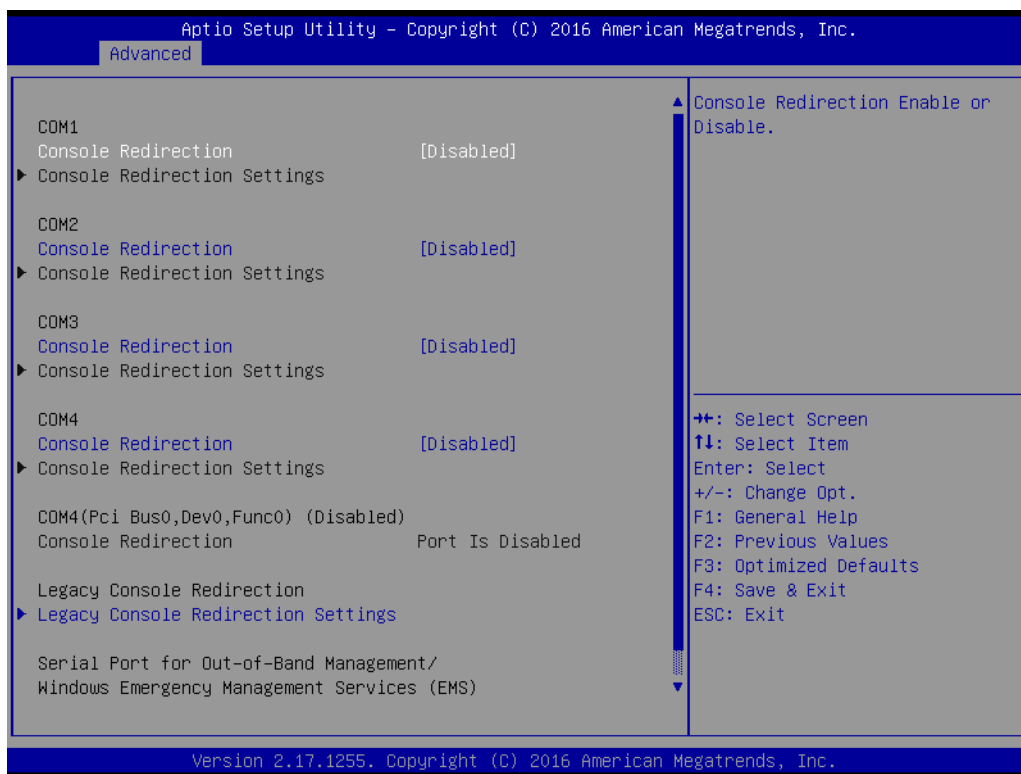

Feature	Options	Description
COM1	Disable Enable	Console Redirection Enable or Disable
Console Redirection Settings	<Sub Menu>	
COM2	Disable Enable	Console Redirection Enable or Disable
Console Redirection Settings	<Sub Menu>	
COM3	Disable Enable	Console Redirection Enable or Disable
Console Redirection Settings	<Sub Menu>	
COM4	Disable Enable	Console Redirection Enable or Disable
Console Redirection Settings	<Sub Menu>	
Legacy Console Redirection Settings	<Sub Menu>	Legacy Console Redirection Settings
Serial Port for Out-of-Band Management / Windows Emergency Management Services (EMS)	Disable Enable	Console Redirection Enable or Disable
Console Redirection Settings	<Sub Menu>	

COMx parameter:

Feature	Options	Description
Terminal Type	VT100 VT100+ VT-UTF8 ANSI	Emulation: ANSI: Extended ASCII char set. VT100: ASCII char set VT100+: Extends VT100 to support color, function keys, etc. VT-UTF8: Uses UTF8 encoding to map Unicode chars onto 1 or more bytes.
Bits per second	9600 19200 38400 57600 115200	Selects serial port transmission speed. The speed must be matched on the other side. Long or noisy lines may require lower speeds.
Data Bits	7 8	Set Data Bits
Parity	None Even Odd Mark Space	A parity bit can be sent with the data bits to detect some transmission errors. Even: parity bit is 0 if the num of 1's in the data bits is even. Odd: parity bit is 0 if num of 1's in the data bits is odd. Mark: parity bit is always 1. Space: parity bit is always 0. Mark and Space Parity do not allow for error detection.
Stop Bits	1 2	Stop bits indicate the end of a serial data packet. (A start bit indicates the beginning). The standard setting is 1 stop bit. Communication with slow devices may require more than 1 stop bit.
Flow Control	None Hardware RTS/CTS	Flow control can prevent data loss from buffer overflow. When sending data, if the receiving buffers are full a 'stop' signal can be sent to stop the data flow. Once the buffers are empty, a 'start' signal can be sent to re-start the flow. Hardware flow control uses two wires to send start/stop signals.
VT-UTF8 Combo Key Support	Disable Enable	Enable VT-UTF8 Combination key support for ANSI/VT100 terminals.
Recorder Mode	Disable Enable	With this mode enabled only text will be sent. This is to capture Terminal data.
Resolution 100x31	Disable Enable	Enables or disables extended terminal resolution
Legacy OS Redirection Resolution	80x24 80x25	On Legacy OS, the number of Rows and Columns supported redirection.
Putty KeyPad	VT100 LINUX XTERMR6 SCO ESCN VT400	Select FunctionKey and KeyPad on Putty.
Redirection After BIOS POST	Always Enable BootLoader	The settings specify if BootLoader is selected then Legacy console redirection is disabled before booting to Legacy OS. Default value is Always Enable which means Legacy console Redirection is enabled for Legacy OS.

## ■ Legacy Console Redirection Settings



Feature	Options	Description
Legacy Serial Redirection Port	COM1	Select a COM port to display redirection of Legacy OS and Legacy OPRM Messages
	COM2	
	COM3	
	COM4	
	COM4 (Pci Bus0, Dev0, Func0) (Disabled)	

### 3.1.2.8 CPU Configuration

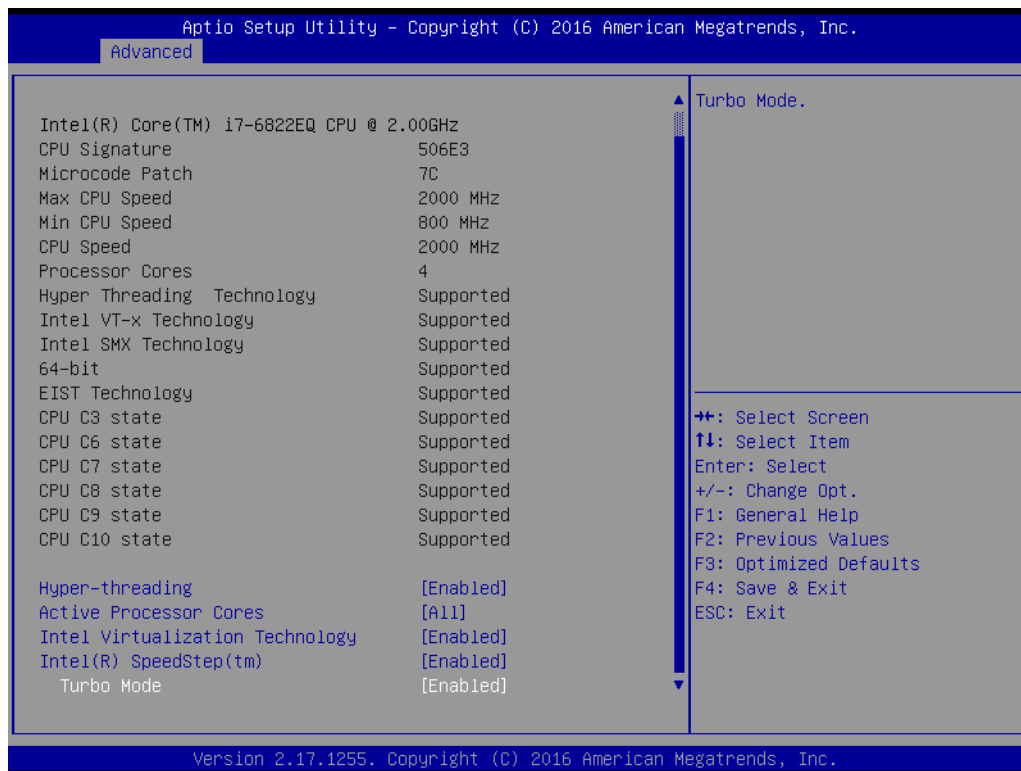
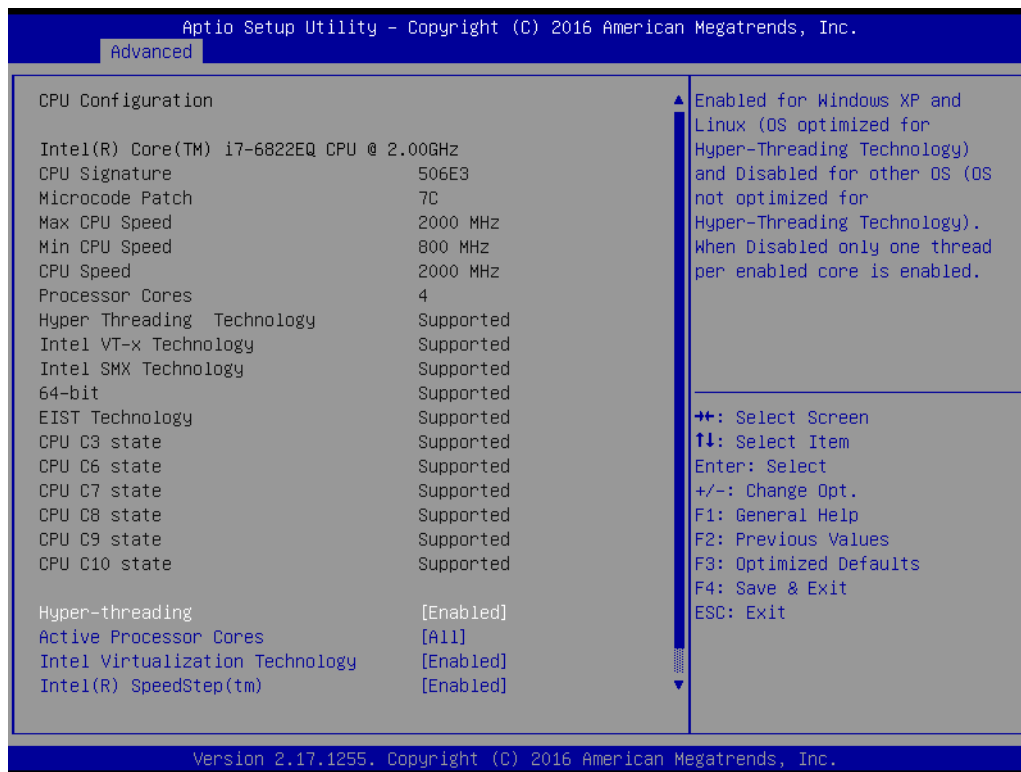

Feature	Options	Description
Hyper-threading	Disable Enable	Enabled or Disable Intel ® Hyper-Threading function.



Active Processor Cores	All 1 2 3	Set active cores number in processor.
Intel Virtualization Technology	Disable Enable	When enabled, a VMM (Virtual Machine Manager) can utilize the additional hardware capabilities provided by Vanderpool Technology
Intel® Speed-Step™	Disable Enable	Enables or Disable Intel SpeedStep function. Allows the system to dynamically adjust processor voltage and core frequency, decreasing average power consumption and heat production.
Turbo Mode	Disable Enable	Enables or Disables Intel® Turbo Boost Technology. This can accelerate processor and graphics performance for peak loads, automatically allowing processor cores to run faster than the rated operating frequency if they're operating below power, current, and temperature specification limits.

### 3.1.2.9 SATA Configuration

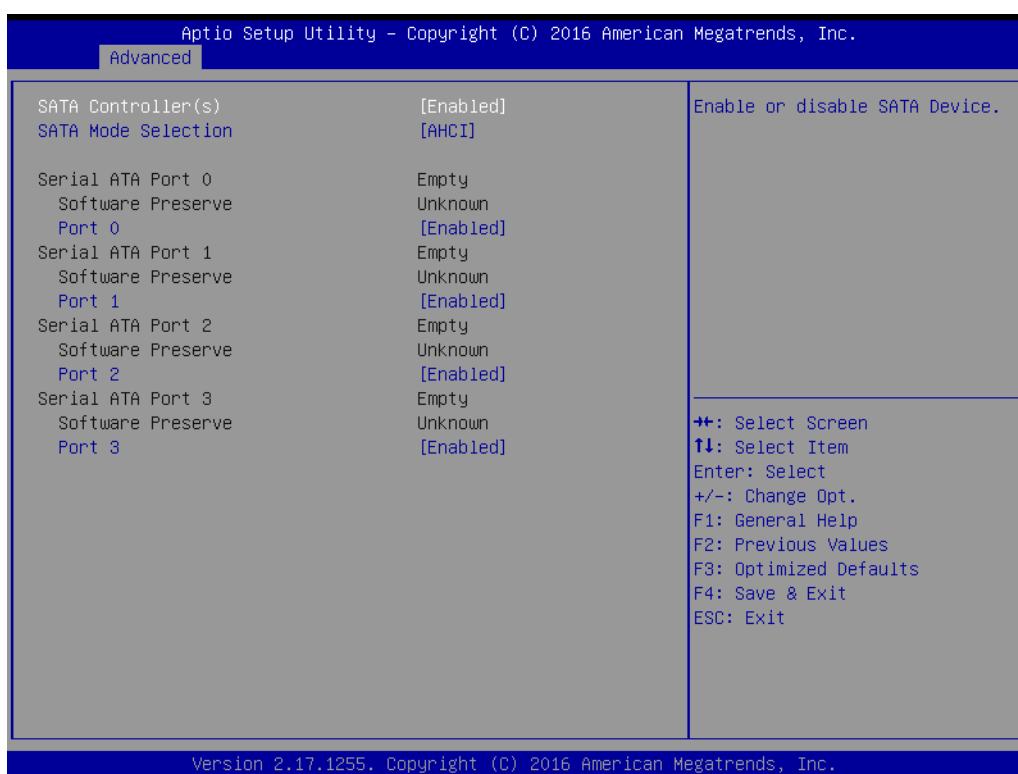

Feature	Options	Description
SATA Controller (s)	Disable Enable	Enable or disable SATA Device.
SATA Mode Selection	AHCI RAID	Determines how SATA controller(s) operate.
Serial ATA Port 0	Disable Enable	Enable or disable SATA port
Serial ATA Port 1	Disable Enable	Enable or disable SATA port

Serial ATA Port 2	Disable Enable	Enable or disable SATA port
Serial ATA Port 3	Disable Enable	Enable or disable SATA port

### 3.1.2.10 Network Stack Configuration



Feature	Options	Description
Network Stack	Disable Enable	Enable or disable the UEFI network stack.
Ipv4 PXE Support	Disable Enable	Enable or disable IPv4 PXE boot support. If disabled, IPv4 PXE boot option will not be created.
Ipv6 PXE Support	Disable Enable	Enable or disable IPv6 PXE boot support. If disabled, IPv6 PXE boot option will not be created.
PXE boot wait time	0~5	Set wait time to press ESC key to abort the PXE boot.
Media detect count	1~50	Set the number of times to check for the presence of media.

## 3.1.2.11 CSM Configuration

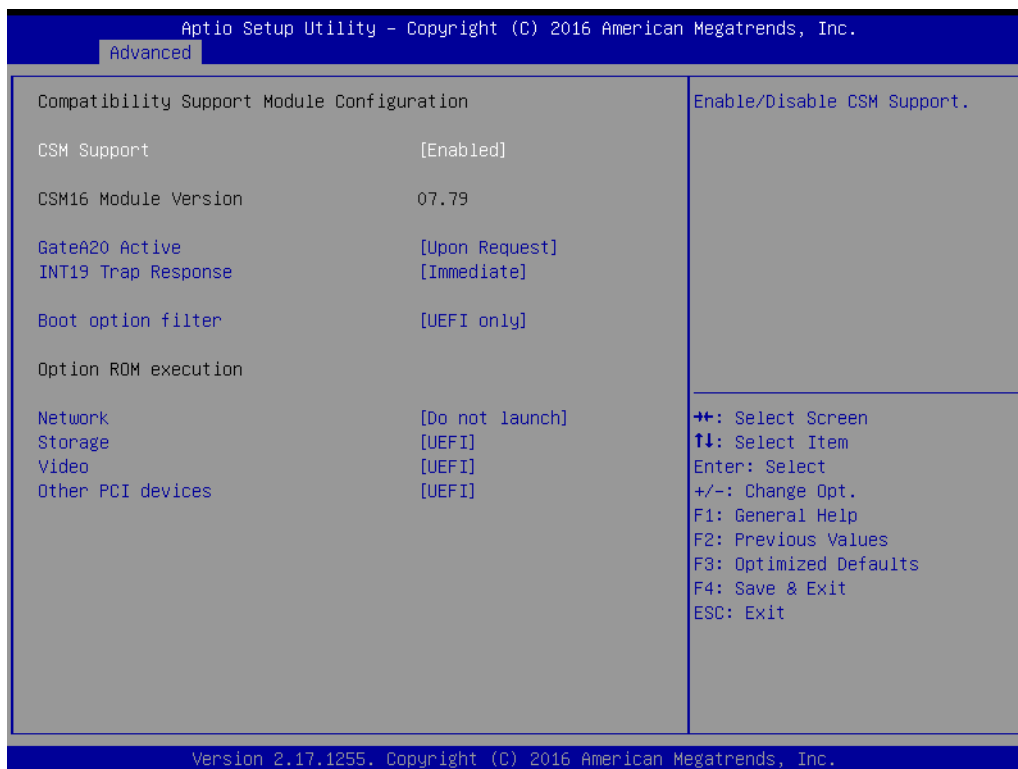

Feature	Options	Description
CSM Support	Disable Enable	Enable/Disable CSM support
Gate A20 Active	Upon Request Always	'Upon Request' - Gate A20 can be disabled with BIOS services. 'Always' - Gate A20 cannot be disabled. Note: This feature is useful if runtime code above 1MB is executed.
INT19 Trap Response	Immediate Postponed	Set BIOS reaction on INT19 trapping by option ROM: 'Immediate' - Executes the trap right away. 'Postponed' - Executes the trap during legacy boot.
Boot option filter	UEFI and Legacy Legacy only UEFI only	This option controls Legacy/UEFI ROMS priority
Network	Do not launch UEFI Legacy	Controls the execution of UEFI and Legacy PXE OpROM
Storage	Do not launch UEFI Legacy	Controls the execution of UEFI and Legacy Storage OpROM
Video	Do not launch UEFI Legacy	Controls the execution of UEFI and Legacy Video OpROM
Other PCI devices	Do not launch UEFI Legacy	Determines OpROM execution policy for devices other than Network, Storage, or Video

**Note!**  **CSM:** The Compatibility Support Module (CSM) is a component of the UEFI firmware that provides legacy BIOS compatibility by emulating a BIOS environment, allowing legacy operating systems and some option ROMs that do not support UEFI to still be used.

CSM also provides required legacy System Management Mode (SMM) functionality, called CompatibilitySmm, as an addition to features provided by the UEFI SMM. This is optional and highly chipset- and platform-specific. An example of such a legacy SMM functionality is providing USB legacy support for keyboard and mouse, by emulating their classic PS/2 counterparts.

### 3.1.2.12 USB Configuration

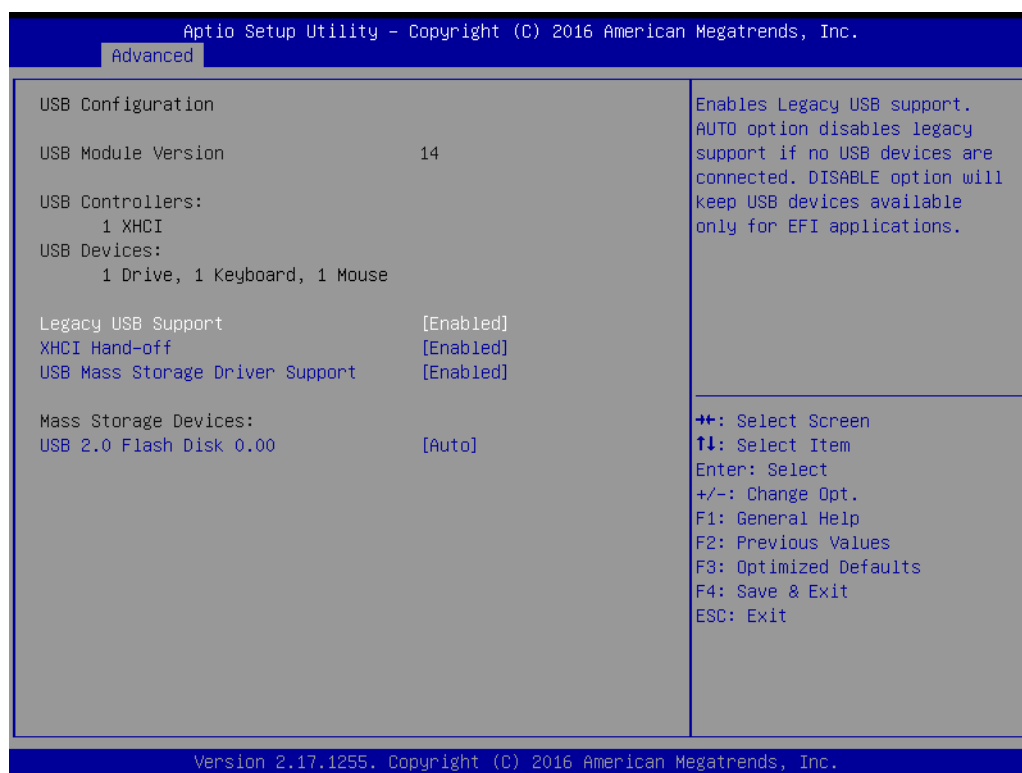

Feature	Options	Description
Legacy USB Support	Disable Enable Auto	Disable this feature to keep USB devices available for EFI applications and BIOS setup only. Select 'Auto' to disable legacy support if no USB devices are connected.
XHCI Hand-off	Disable Enable	This feature is a workaround for operating system without xHCI hand-off support. Note: If this feature is enabled, the xHCI ownership change should be claimed by the xHCI operating system driver.
USB Mass Storage Driver Support	Disable Enable	Enable/Disable USB Mass Storage Driver Support.

### 3.1.3 Chipset

Select the **Chipset** tab from the **SOM-5897** setup screen to enter the Chipset BIOS Setup screen. You can display a Chipset BIOS Setup option by highlighting it using the <Arrow> keys. All Plug and Play BIOS Setup options are described in this section. The Plug and Play BIOS Setup screen is shown below.

#### 3.1.3.1 System Agent & PCH Configuration

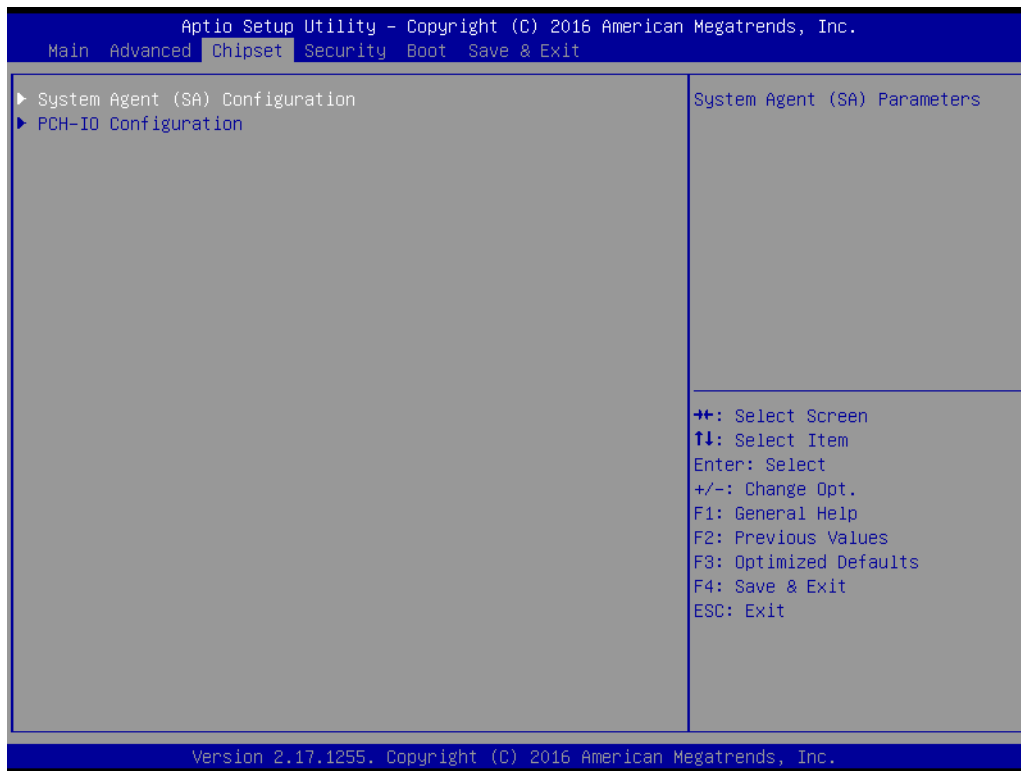

Feature	Options	Description
System Agent (SA) Configuration	<Sub Menu>	Config System Agent Parameters
PCH-IO Configuration	<Sub Menu>	Config PCH Parameters

## ■ System Agent Bridge Name

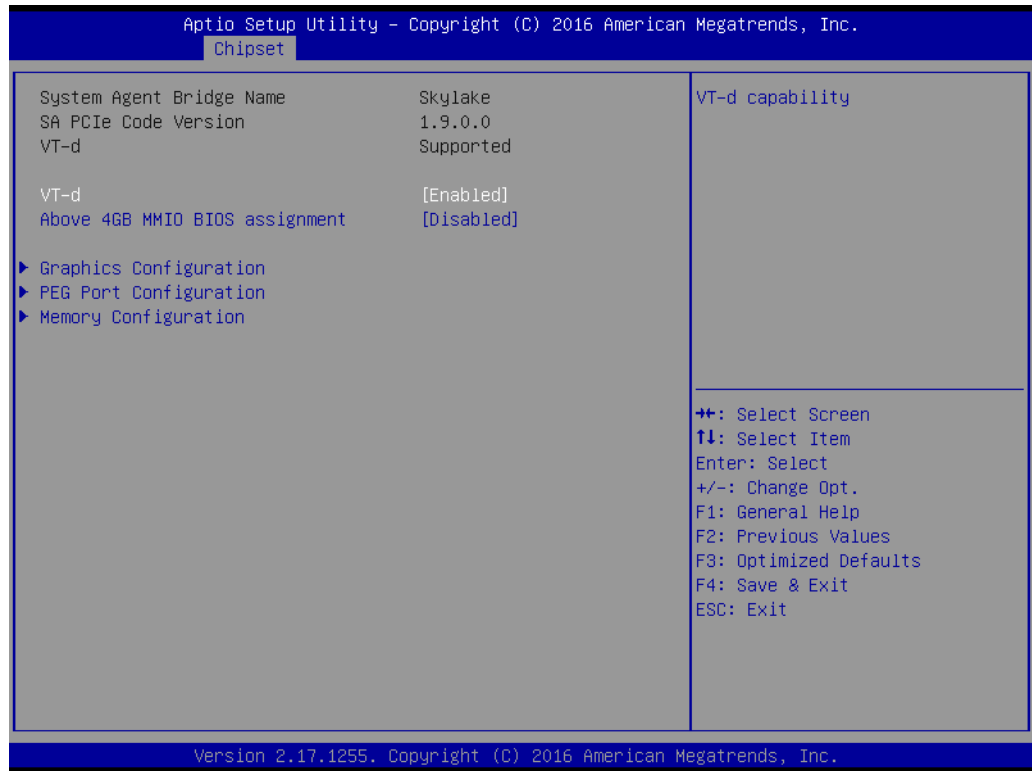

Feature	Options	Description
VT-d	Disable Enable	Enable/Disable VT-d (Intel® Virtualization Technology for Directed I/O)
Above 4GB MMIO BIOS assignment	Disable Enable	Enable/Disable above 4GB MemoryMappedIO BIOS assignment This is disabled automatically when Aperture Size is set to 2048MB.

## ■ Graphics Configuration

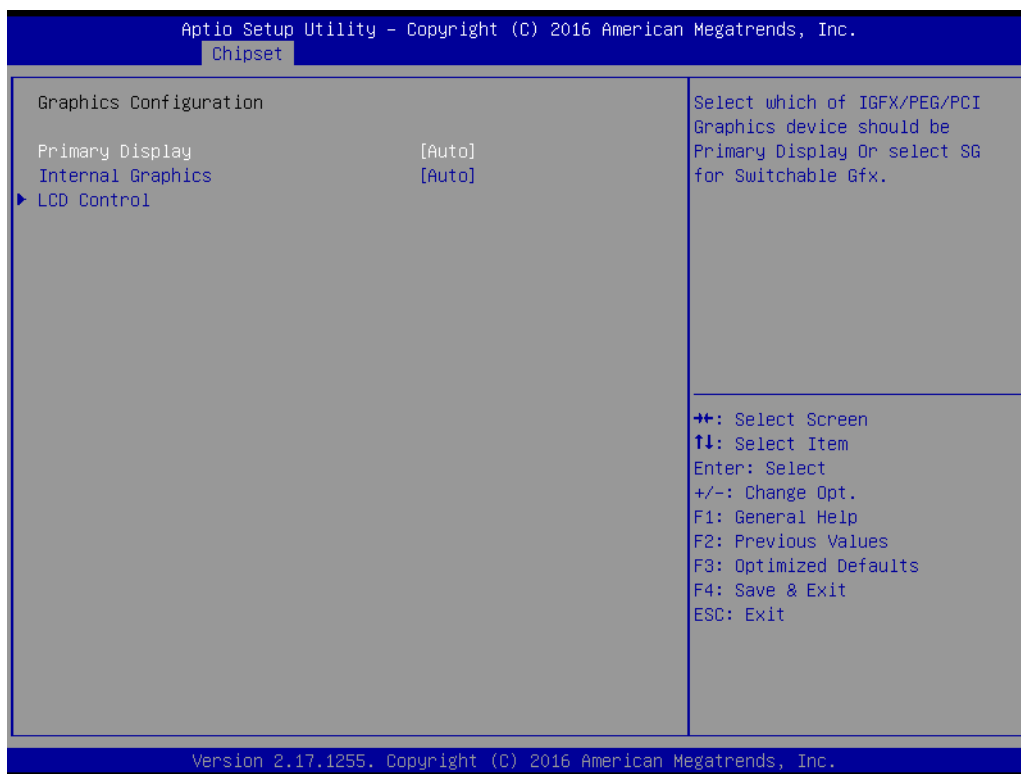

Feature	Options	Description
Primary Display	Auto IGFX PEG PCIE	Select which of IGFX/PEG/PCI Graphics device should be Primary Display.
Internal Graphics	Auto Disabled Enabled	Keep IGFX enabled based on the setup options.

## LCD Control

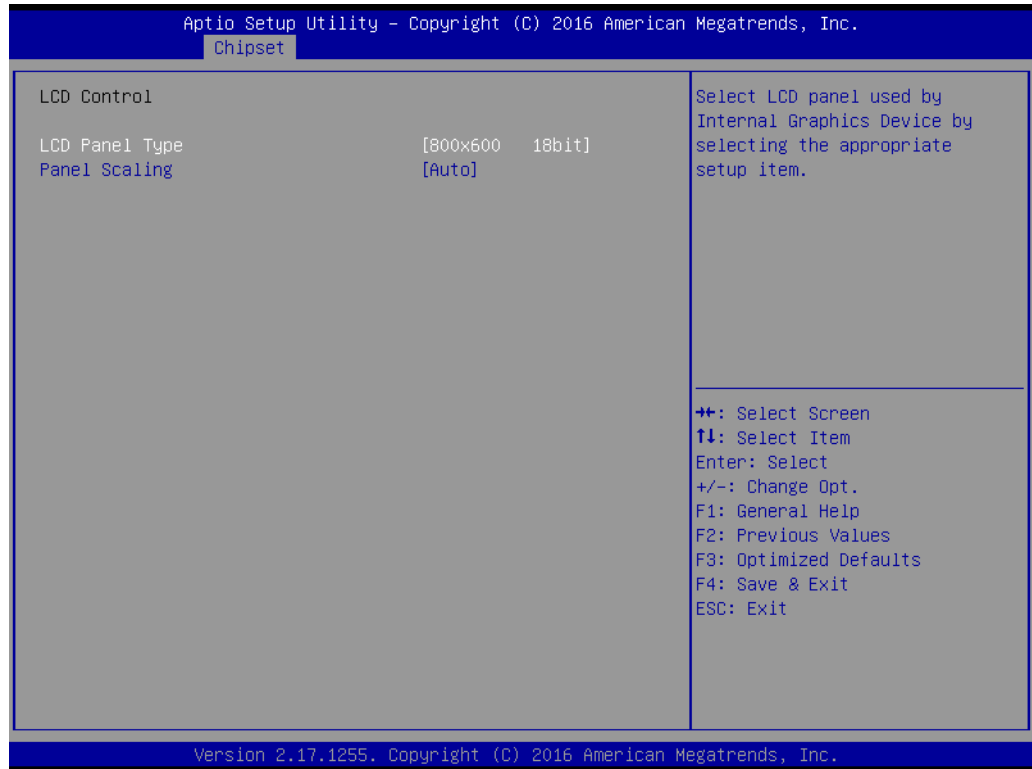

Feature	Options	Description
LCD Panel Type	800x600 18bit	Select LCD panel used by Internal Graphics Device by selecting the appropriate setup item.
	1024x768 18bit	
	1024x768 24bit	
	1280x800 18bit	
	1280x1024 48bit	
	1366x768 24bit	
	1440x900 48bit	
	1680x1050 48bit	
	1600x1200 48bit	
	1920x1080 48bit	
	1920x1200 48bit	
	Customize 1	
Customize 2		
Customize 3		
Disable CH7511		
Panel Scaling	Auto	Select the LCD panel scaling option used by the Internal Graphics Device.
	Off	
	Force Scaling	



■ **PEG Port Configuration**

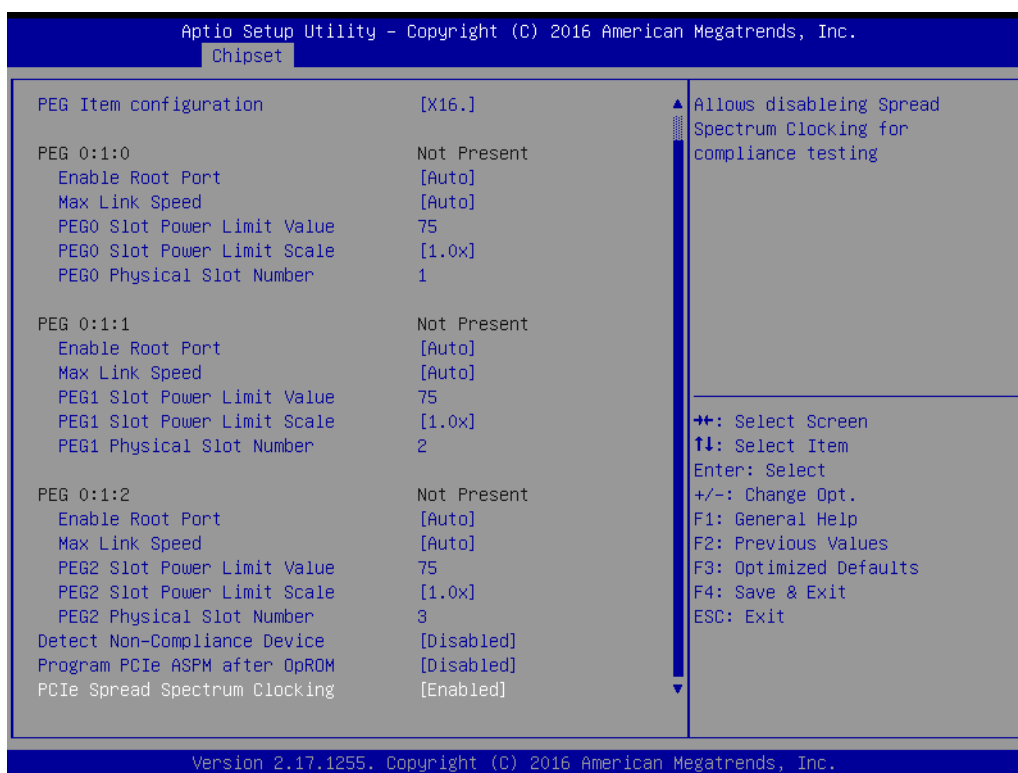
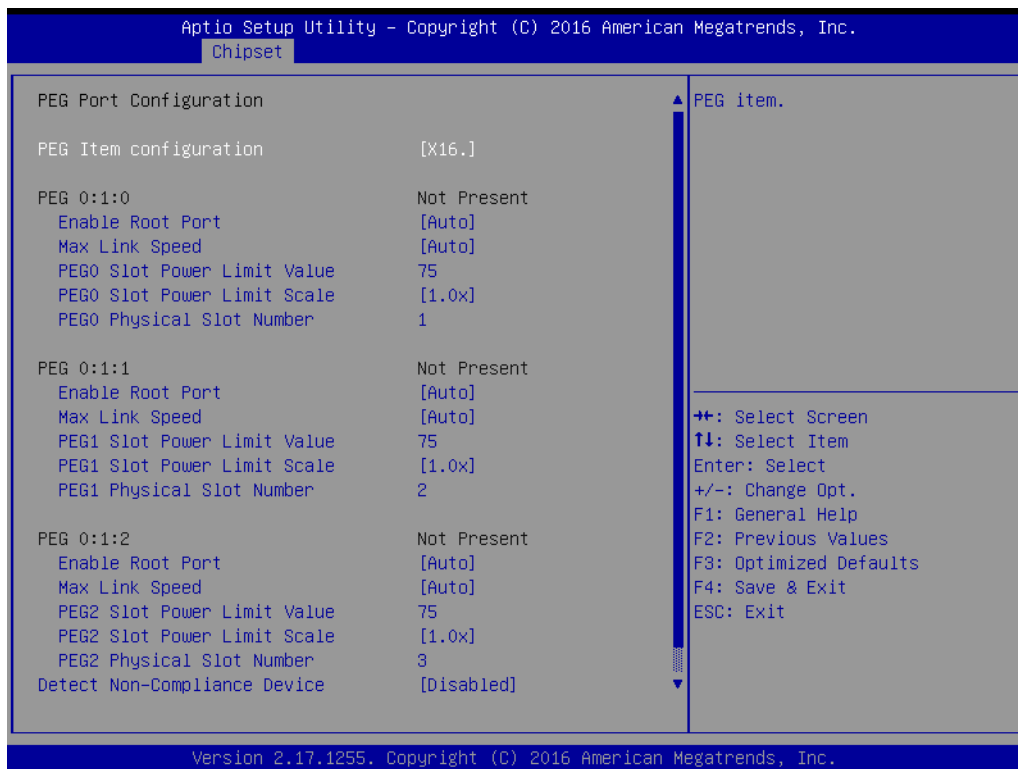

Feature	Options	Description
PEG Item configuration	1X8, 2X4. 2X8. X16.	PEG item.
PEG 0:1:0		

Enable Root Port	Disabled Enabled Auto	Enable or Disable the Root Port
Max Link Speed	Auto Gen1 Gen2 Gen3	Configure PEG 0:1:0 Max Speed
PEG0 Slot Power Limit Value	0~255	Set the upper limit on power supplied by slot. Power limit (in Watts) is calculated by multiplying this value by the Slot Power limit Scale. Values 0-255
PEG0 slot Power Limit Scale	1.0x 0.1x 0.01x 0.001x	Select the scale used for the Slot Power Limit Value.
PEG0 Physical Slot Number	0~8191	Set the physical slot number attached to be globally unique within the chassis Values 0-8191
PEG 0:1:1		
Enable Root Port	Disabled Enabled Auto	Enable or Disable the Root Port
Max Link Speed	Auto Gen1 Gen2 Gen3	Configure PEG 0:1:1 Max Speed
PEG1 Slot Power Limit Value	0~255	Set the upper limit on power supplied by slot. Power limit (in Watts) is calculated by multiplying this value by the Slot Power limit Scale. Values 0-255
PEG1 slot Power Limit Scale	1.0x 0.1x 0.01x 0.001x	Select the scale used for the Slot Power Limit Value.
PEG1 Physical Slot Number	0~8191	Set the physical slot number attached to be globally unique within the chassis Values 0-8191
PEG 0:1:2		
Enable Root Port	Disabled Enabled Auto	Enable or Disable the Root Port
Max Link Speed	Auto Gen1 Gen2 Gen3	Configure PEG 0:1:2 Max Speed
PEG2 Slot Power Limit Value	0~255	Set the upper limit on power supplied by slot. Power limit (in Watts) is calculated by multiplying this value by the Slot Power limit Scale. Values 0-255
PEG2 slot Power Limit Scale	1.0x 0.1x 0.01x 0.001x	Select the scale used for the Slot Power Limit Value.
PEG2 Physical Slot Number	0~8191	Set the physical slot number attached to be globally unique within the chassis Values 0-8191

Detect Non-Compliance Device	Disabled Enabled
Program PCIe ASPM after OpROM	Disabled Enabled
PCIe Spread Spectrum Clocking	Disabled Enabled

### ■ Memory Configuration

This page shows memory information.

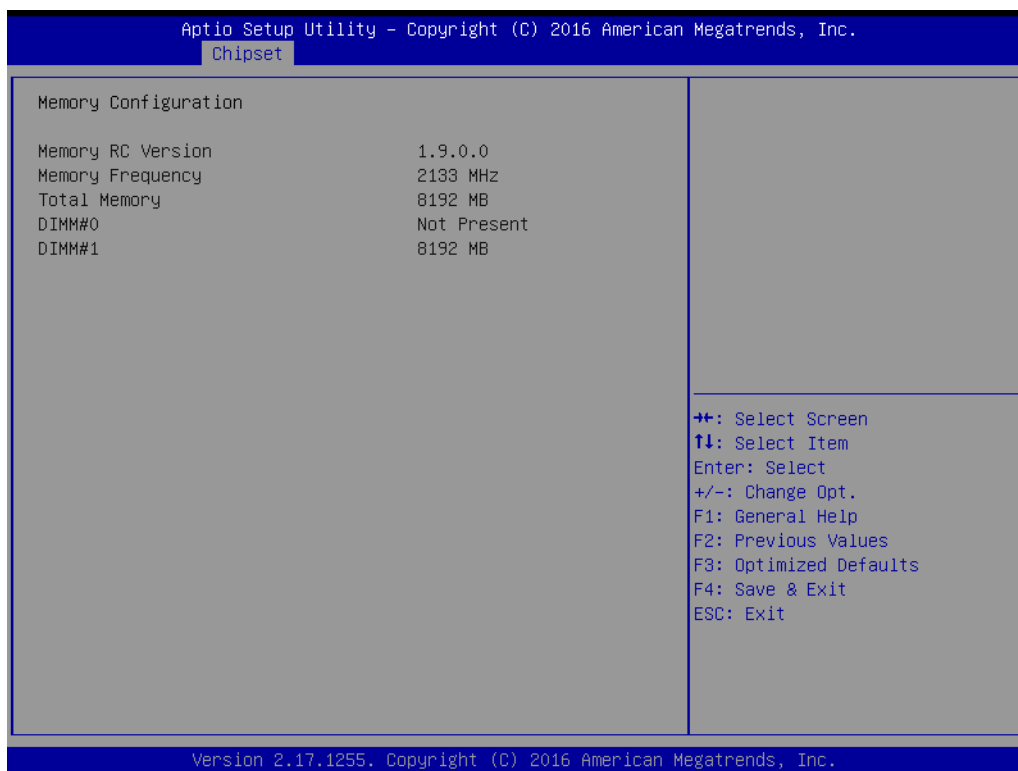

### 3.1.3.2 PCH-IO Configuration

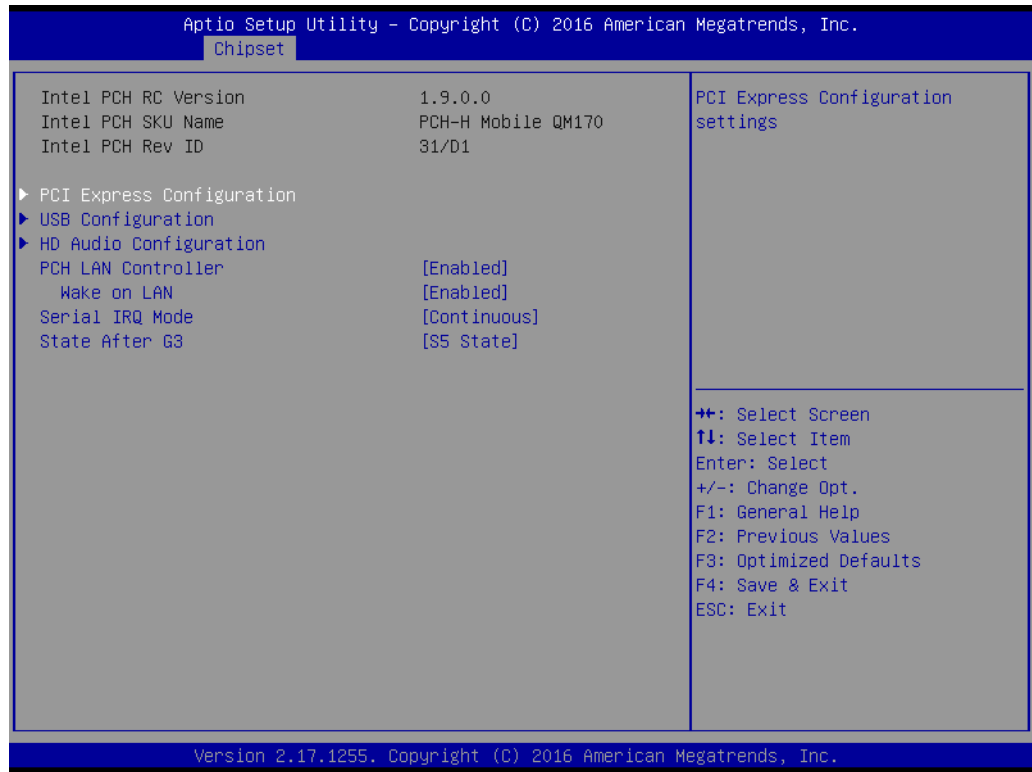

Feature	Options	Description
PCH LAN Controller	Enabled Disabled	Enable or disable onboard NIC.
Wake on LAN	Enabled Disabled	Enable or disable integrated LAN to wake the system. (The Wake On LAN cannot be disabled if ME is on at Sx state.)
Serial IRQ Mode	Quiet Continuous	Configure Serial IRQ Mode
State After G3	S0 State S5 State	Specify what state to go to when power is re-applied after a power failure (G3 state).

## ■ PCI Express Configuration

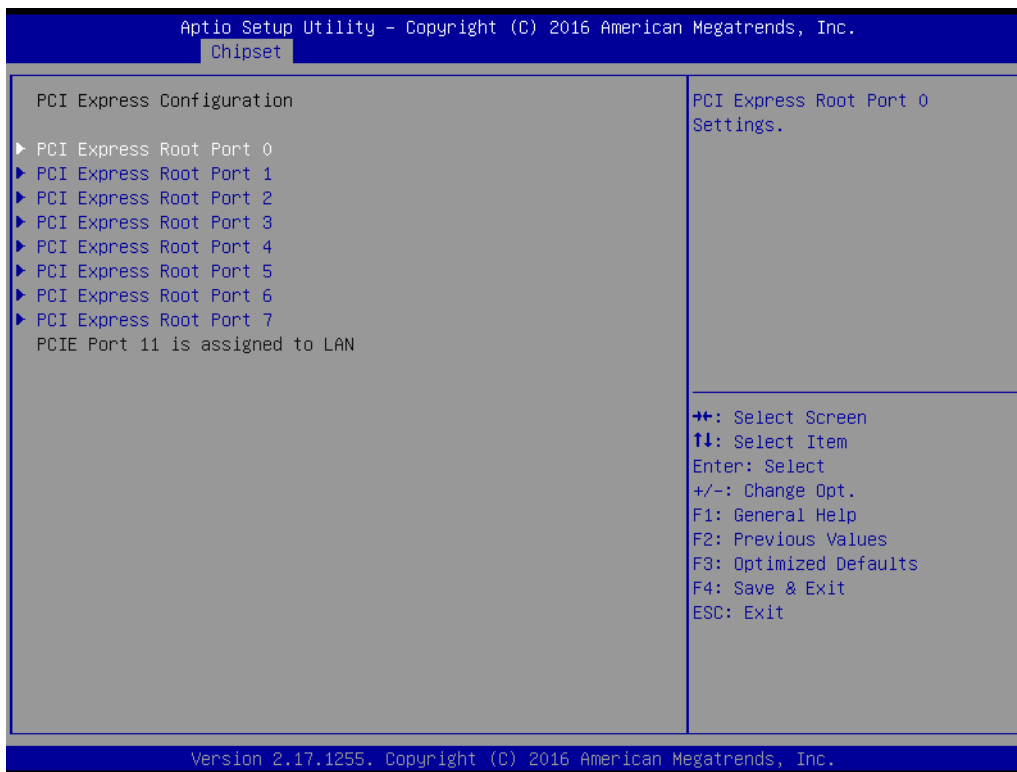

### – PCI Express Root Port 0~7

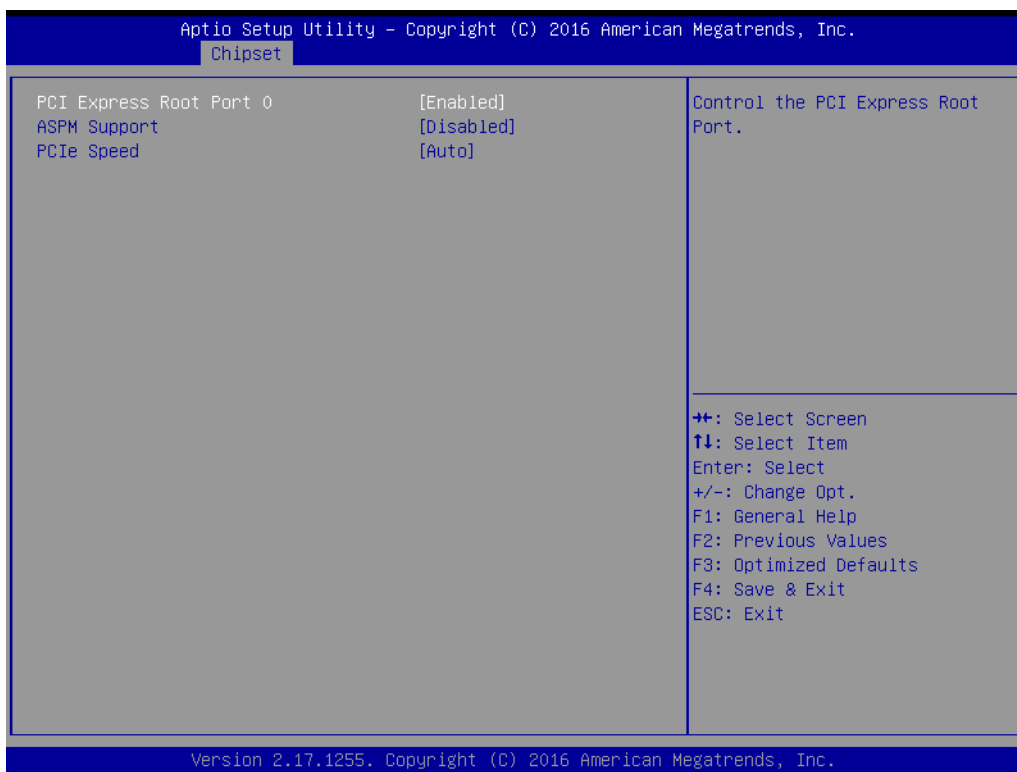

Feature	Options	Description
PCI Express Root Port 0~7	Disabled Enabled	Control the PCI Express Root Port.
ASPM Support	Disabled L0s L1 L0sL1 Auto	Set the ASPM Level: Force L0s - Force all links to L0s State Auto - BIOS auto configure Disable - Disable ASPM
PCIe Speed	Auto Gen1 Gen2 Gen3	

## ■ USB Configuration

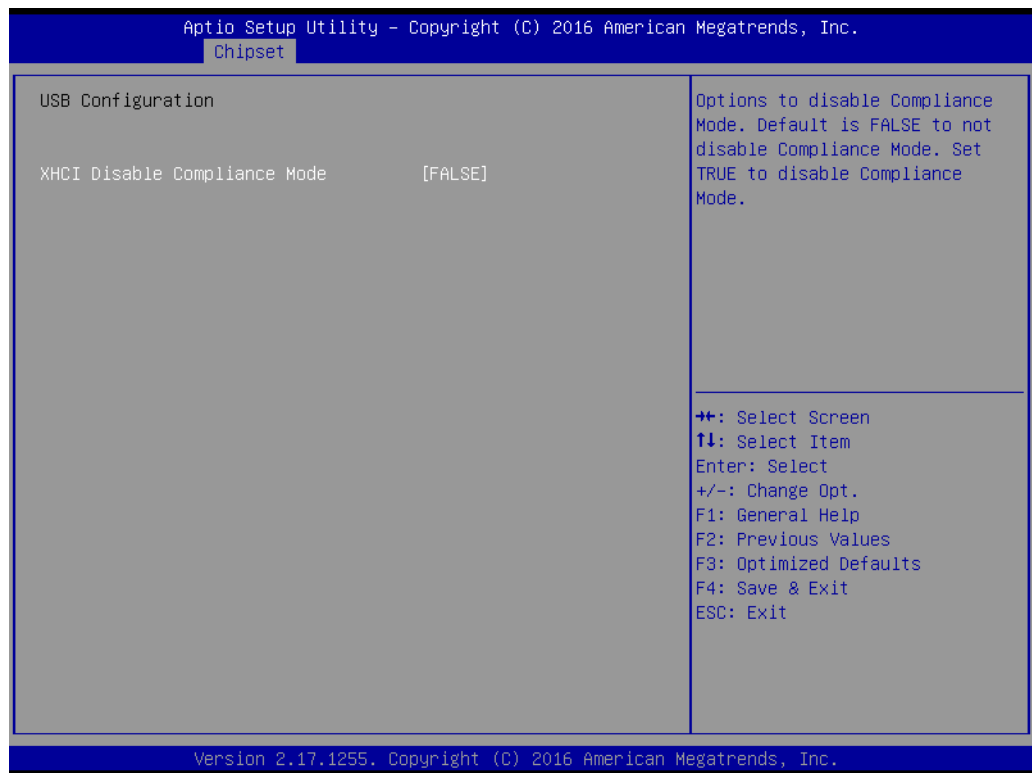

Feature	Options	Description
XHCI Disable Compliance Mode	FALSE TRUE	Options to disable Compliance Mode. Default is FALSE to not disable Compliance Mode. Set TRUE to disable Compliance Mode.

## ■ HD Audio Configuration



Feature	Options	Description
HD Audio	Disabled Enabled Auto	Control Detection of the HD-Audio device. Disabled = HDA will be unconditionally disabled. Enabled = HDA will be unconditionally enabled Auto = HDA will be enabled if present, disabled otherwise.

### 3.1.4 Security

Select **Security** tab from the **SOM-5897** main BIOS setup menu. All security setup options, such as password protection are described in this section. To access the sub menu for the following items, select the item and press <Enter>:

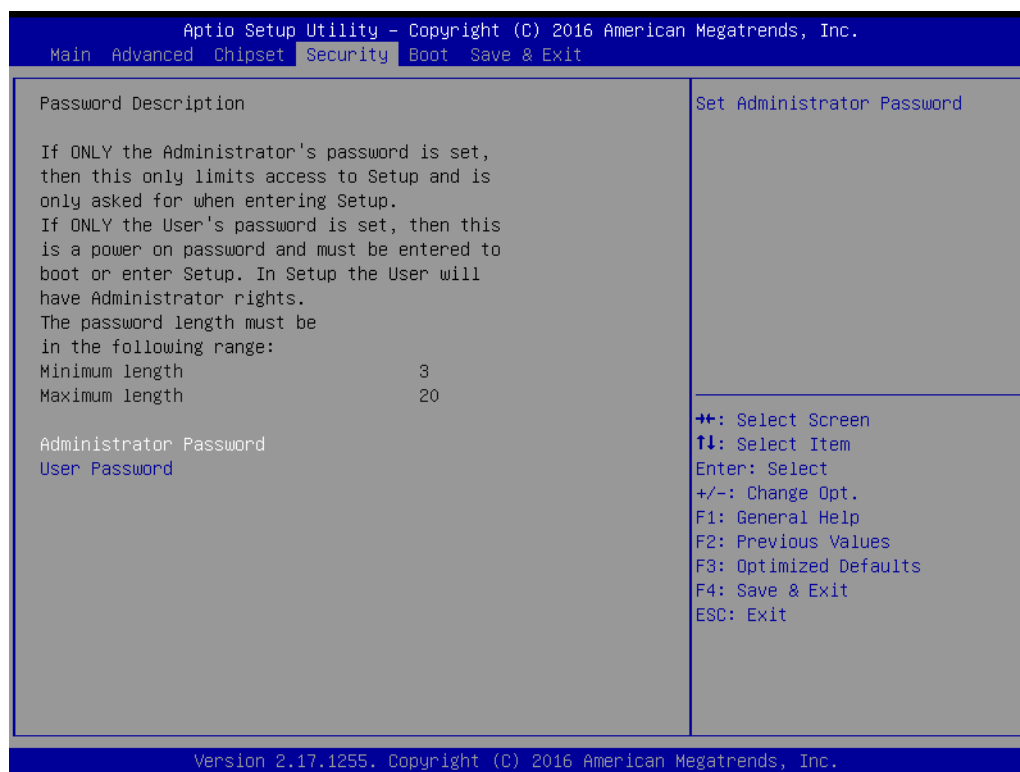

**Change Administrator / User Password:** Select this option and press **Enter** to access the sub menu, and then type in the password.

The password length is Minimum 3 digits and maximum 20 digits.

If you set "Administrator Password" only, it will require a password only when entering the BIOS setup.

If you set "User Password" only, it will require a password every boot-up. However, if the Administrator password is not set, using "User Password" to enter the BIOS setup will permit all access privileges.

If you set both passwords, it will require a password every boot-up. To boot into the OS, you can use either password. To enter BIOS setup, "Administrator Password" gives all privileges to access all items, while "User Password" only gives partial privileges.

**Note!** *Please keep your password safe. For security reasons, the BIOS password can't be reset by clearing CMOS. If you forget your password, please contact Advantech for technical support.*





### 3.1.5 Boot Settings

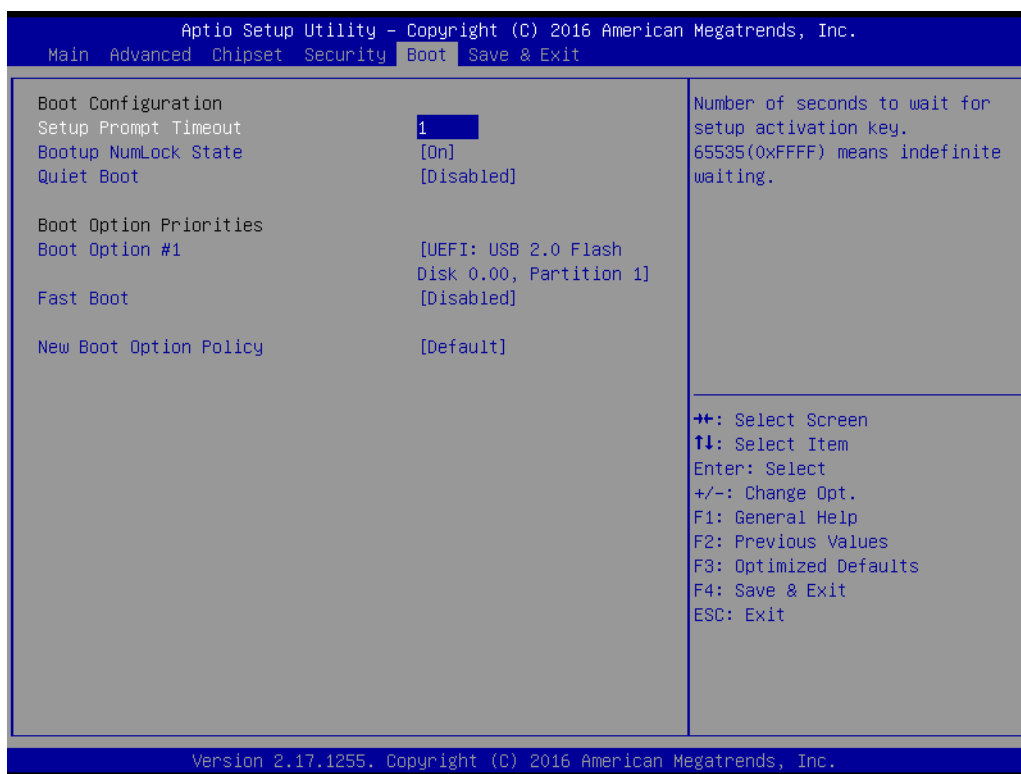

Feature	Options	Description
<b>Boot Configuration</b>		
Setup Prompt Timeout	1~65535	Number of seconds to wait for setup activation key. 65535 (0xFFFF) means indefinite waiting.
Bootup NumLock State	On Off	Select the keyboard Numlock state
Quiet Boot	Disabled Enabled	Enables or disables Quiet Boot option
<b>Boot Option Priorities</b>		
Fast Boot	Disabled Enabled	Enables or disables boot with initialization of a minimal set of devices required to launch active boot option. Has no effect for BBS boot options.
New Boot Option Policy	Default Place First Place Last	Controls the placement of newly detected UEFI boot options

### 3.1.6 Save & Exit

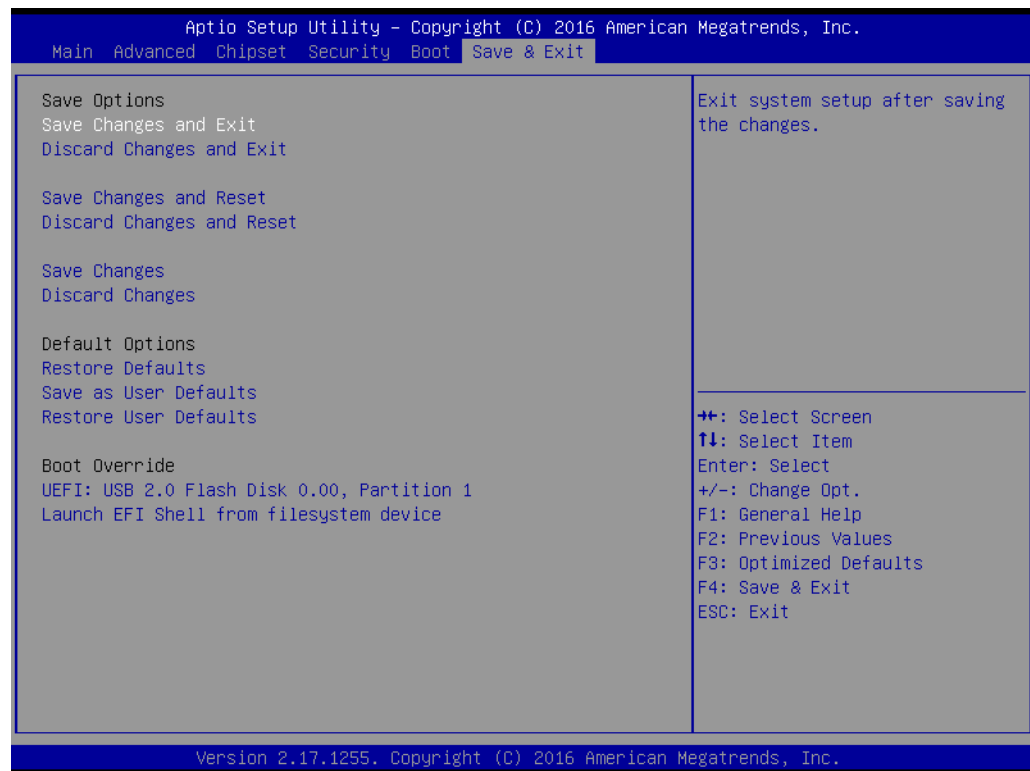

Feature	Options	Description
<b>Save Options</b>		
Save Changes and Exit	Yes No	Exit system setup after saving the changes.
Discard Changes and Exit	Yes No	Exit system setup without saving any changes.
Save Changes and Reset	Yes No	Reset the system after saving the changes.
Discard Changes and Reset	Yes No	Reset system setup without saving any changes.
Save Changes	Yes No	Save Changes done so far to any of the setup options.
Discard Changes	Yes No	Discard changes done so far to any of the setup options.
<b>Default Options</b>		
Restore Defaults	Yes No	Restore/Load Default values for all the setup options.
Save as User Defaults	Yes No	Save the changes done so far as User Defaults.
Restore User Defaults	Yes No	Restore the User Defaults to all the setup options.
<b>Boot Override</b>		
<Bootable device list>		The bootable devices are displayed in the list. Select one of the devices to boot. It only changes on this boot, and will not change the default boot sequence.
Launch EFI Shell from filesystem device		Attempts to Launch EFI Shell application (Shell.efi) from one of the available filesystem devices.

# Chapter 4

## S/W Introduction & Installation

Sections include:

- S/W Introduction
- Driver Installation
- Advantech iManager

---

## 4.1 S/W Introduction

The mission of Advantech Embedded Software Services is to "Enhance quality of life with Advantech platforms and Microsoft Windows embedded technology." We enable Windows Embedded software products on Advantech platforms to more effectively support the embedded computing community. Customers are freed from the hassle of dealing with multiple vendors (Hardware suppliers, System integrators, Embedded OS distributor) for projects. Our goal is to make Windows Embedded Software solutions easily and widely available to the embedded computing community.

## 4.2 Driver Installation

To install the drivers on a windows-based operation system, please connect to the interweb and browse to the website <http://support.advantech.com.tw> and download the drivers that you want to install and follow Driver Setup instructions to complete the installation.

### 4.2.1 Windows Driver Setup

To install the drivers on a windows-based OS, please connect to the internet and go to <http://support.advantech.com.tw> to download the drivers that you want to install and follow Driver Setup instructions to complete the installation.











### 4.2.2 Other OS

To install the drivers for other OS, please connect to internet and browse the browse the website <http://support.advantech.com.tw> to download the setup file.

## 4.3 Advantech iManager

Advantech's platforms come equipped with iManager, a micro controller that provides embedded features for system integrators. Embedded features have been moved from the OS/BIOS level to the board level, to increase reliability and simplify integration.

iManager runs whether the operating system is running or not; it can count the boot times and running hours of the device, monitor device health, and provide an advanced watchdog to handle errors as they happen. iManager also comes with a secure & encrypted EEPROM for storing important security keys or other customer information. All the embedded functions are configured through the API and provide corresponding utilities to demonstrate. These APIs comply with PICMG EAPI (Embedded Application Programmable Interface) specifications and makes these embedded features easier to integrate, speed development schedules, and provide customer's with software continuity while upgrading hardware. For more details of how to use the APIs and utilities, please refer to the Advantech iManager 2.0 Software API User Manual.

<b>Control</b>	<b>Monitor</b>
 <p><b>GPIO</b></p> <p>General Purpose Input/Output is a flexible parallel interface that allows a variety of custom connections. It allows users to monitor the level of signal input or set the output status to switch on/off a device. Our API also provides Programmable GPIO, which allows developers to dynamically set the GPIO input or output status.</p>	 <p><b>Watchdog</b></p> <p>A watchdog timer (WDT) is a device that performs a specific operation after a certain period of time if something goes wrong and the system does not recover on its own. A watchdog timer can be programmed to perform a warm boot (restarting the system) after a certain number of seconds.</p>
 <p><b>SMBus</b></p> <p>SMBus is the System Management Bus defined by Intel® Corporation in 1995. It is used in personal computers and servers for low-speed system management communications. The SMBus API allows a developer to interface a embedded system environment and transfer serial messages using the SMBus protocols, allowing multiple simultaneous device control.</p>	 <p><b>Hardware Monitor</b></p> <p>The Hardware Monitor (HWM) API is a system health supervision API that inspects certain condition indexes, such as fan speed, temperature and voltage.</p>
 <p><b>I2C</b></p> <p>I2C is a bi-directional two wire bus that was developed by Philips for use in their televisions in the 1980s. The I2C API allows a developer to interface with an embedded system environment and transfer serial messages using the I2C protocols, allowing multiple simultaneous device control.</p>	 <p><b>Hardware Control</b></p> <p>The Hardware Control API allows developers to set the PWM (Pulse Width Modulation) value to adjust fan speed or other devices; it can also be used to adjust the LCD brightness.</p>
<b>Display</b>	<b>Power Saving</b>
 <p><b>Brightness Control</b></p> <p>The Brightness Control API allows a developer to interface with an embedded device to easily control brightness.</p>	 <p><b>CPU Speed</b></p> <p>Make use of Intel SpeedStep technology to reduce power power consumption. The system will automatically adjust the CPU Speed depending on system loading.</p>
 <p><b>Backlight</b></p> <p>The Backlight API allows a developer to control the backlight (screen) on/off in an embedded device.</p>	 <p><b>System Throttling</b></p> <p>Refers to a series of methods for reducing power consumption in computers by lowering the clock frequency. These APIs allow the user to lower the clock from 87.5% to 12.5%.</p>



# Appendix **A**

## Pin Assignment

This appendix gives you the information about the hardware pin assignment of the SOM-5897 CPU System on Module.

Sections include:

- SOM-5897 Type 6 Pin Assignment

## A.1 SOM-5897 Type 6 Pin Assignment

This section gives SOM-5897 pin assignment on COM Express connector which compliant with COMR.0 R2.1 Type 6 pin-out definitions. More details about how to use these pins and get design reference, please contact to Advantech for design guide, checklist, reference schematic, and other hardware/software supports.

SOM-5897 Row A,B			
A1	GND (FIXED)	B1	GND (FIXED)
A2	GBE0_MDI3-	B2	GBE0_ACT#
A3	GBE0_MDI3+	B3	LPC_FRAME#
A4	GBE0_LINK100#	B4	LPC_AD0
A5	GBE0_LINK1000#	B5	LPC_AD1
A6	GBE0_MDI2-	B6	LPC_AD2
A7	GBE0_MDI2+	B7	LPC_AD3
A8	GBE0_LINK#	B8	N/A
A9	GBE0_MDI1-	B9	N/A
A10	GBE0_MDI1+	B10	LPC_CLK
A11	GND (FIXED)	B11	GND (FIXED)
A12	GBE0_MDI0-	B12	PWRBTN#
A13	GBE0_MDI0+	B13	SMB_CK
A14	N/A	B14	SMB_DAT
A15	SUS_S3#	B15	SMB_ALERT#
A16	SATA0_TX+	B16	SATA1_TX+
A17	SATA0_TX-	B17	SATA1_TX-
A18	SUS_S4#	B18	SUS_STAT#
A19	SATA0_RX+	B19	SATA1_RX+
A20	SATA0_RX-	B20	SATA1_RX-
A21	GND (FIXED)	B21	GND (FIXED)
A22	SATA2_TX+	B22	SATA3_TX+
A23	SATA2_TX-	B23	SATA3_TX-
A24	SUS_S5#	B24	PWR_OK
A25	SATA2_RX+	B25	SATA3_RX+
A26	SATA2_RX-	B26	SATA3_RX-
A27	BATLOW#	B27	WDT
A28	(S)ATA_ACT#	B28	N/A
A29	HDA_SYNC	B29	HDA_SDIN1
A30	HDA_RST#	B30	HDA_SDIN0
A31	GND (FIXED)	B31	GND (FIXED)
A32	HDA_BITCLK	B32	SPKR
A33	HDA_SDOUT	B33	I2C_CK
A34	BIOS_DIS0#	B34	I2C_DAT
A35	THRMTRIP#	B35	THRM#
A36	USB6-	B36	USB7-
A37	USB6+	B37	USB7+
A38	USB_6_7_OC#	B38	USB_4_5_OC#
A39	USB4-	B39	USB5-
A40	USB4+	B40	USB5+
A41	GND (FIXED)	B41	GND (FIXED)
A42	USB2-	B42	USB3-



A43	USB2+	B43	USB3+
A44	USB_2_3_OC#	B44	USB_0_1_OC#
A45	USB0-	B45	USB1-
A46	USB0+	B46	USB1+
A47	VCC_RTC	B47	EXCD1_PERST#
A48	EXCD0_PERST#	B48	EXCD1_CPPE#
A49	EXCD0_CPPE#	B49	SYS_RESET#
A50	LPC_SERIRQ	B50	CB_RESET#
A51	GND (FIXED)	B51	GND (FIXED)
A52	PCIE_TX5+	B52	PCIE_RX5+
A53	PCIE_TX5-	B53	PCIE_RX5-
A54	GPI0	B54	GPO1
A55	PCIE_TX4+	B55	PCIE_RX4+
A56	PCIE_TX4-	B56	PCIE_RX4-
A57	GND	B57	GPO2
A58	PCIE_TX3+	B58	PCIE_RX3+
A59	PCIE_TX3-	B59	PCIE_RX3-
A60	GND (FIXED)	B60	GND (FIXED)
A61	PCIE_TX2+	B61	PCIE_RX2+
A62	PCIE_TX2-	B62	PCIE_RX2-
A63	GPI1	B63	GPO3
A64	PCIE_TX1+	B64	PCIE_RX1+
A65	PCIE_TX1-	B65	PCIE_RX1-
A66	GND	B66	WAKE0#
A67	GPI2	B67	WAKE1#
A68	PCIE_TX0+	B68	PCIE_RX0+
A69	PCIE_TX0-	B69	PCIE_RX0-
A70	GND (FIXED)	B70	GND (FIXED)
A71	LVDS_A0+	B71	LVDS_B0+
A72	LVDS_A0-	B72	LVDS_B0-
A73	LVDS_A1+	B73	LVDS_B1+
A74	LVDS_A1-	B74	LVDS_B1-
A75	LVDS_A2+	B75	LVDS_B2+
A76	LVDS_A2-	B76	LVDS_B2-
A77	LVDS_VDD_EN	B77	LVDS_B3+
A78	LVDS_A3+	B78	LVDS_B3-
A79	LVDS_A3-	B79	LVDS_BKLT_EN
A80	GND (FIXED)	B80	GND (FIXED)
A81	LVDS_A_CK+	B81	LVDS_B_CK+
A82	LVDS_A_CK-	B82	LVDS_B_CK-
A83	LVDS_I2C_CK	B83	LVDS_BKLT_CTRL
A84	LVDS_I2C_DAT	B84	VCC_5V_SBY
A85	GPI3	B85	VCC_5V_SBY
A86	N/A	B86	VCC_5V_SBY
A87	eDP_HPD	B87	VCC_5V_SBY
A88	PCIE_CLK_REF+	B88	BIOS_DIS1#
A89	PCIE_CLK_REF-	B89	VGA_RED
A90	GND (FIXED)	B90	GND (FIXED)

A91	SPI_POWER	B91	VGA_GRN
A92	SPI_MISO	B92	VGA_BLU
A93	GPO0	B93	VGA_HSYNC
A94	SPI_CLK	B94	VGA_VSYNC
A95	SPI_MOSI	B95	VGA_I2C_CK
A96	TPM_PP	B96	VGA_I2C_DAT
A97	N/A	B97	SPI_CS#
A98	SER0_TX	B98	N/A
A99	SER0_RX	B99	N/A
A100	GND (FIXED)	B100	GND (FIXED)
A101	SER1_TX	B101	FAN_PWMOUT
A102	SER1_RX	B102	FAN_TACHIN
A103	LID#	B103	SLEEP#
A104	VCC_12V	B104	VCC_12V
A105	VCC_12V	B105	VCC_12V
A106	VCC_12V	B106	VCC_12V
A107	VCC_12V	B107	VCC_12V
A108	VCC_12V	B108	VCC_12V
A109	VCC_12V	B109	VCC_12V
A110	GND (FIXED)	B110	GND (FIXED)
SOM-5897 Row C,D			
C1	GND (FIXED)	D1	GND (FIXED)
C2	GND	D2	GND
C3	USB_SSRX0-	D3	USB_SSTX0-
C4	USB_SSRX0+	D4	USB_SSTX0+
C5	GND	D5	GND
C6	USB_SSRX1-	D6	USB_SSTX1-
C7	USB_SSRX1+	D7	USB_SSTX1+
C8	GND	D8	GND
C9	USB_SSRX2-	D9	USB_SSTX2-
C10	USB_SSRX2+	D10	USB_SSTX2+
C11	GND (FIXED)	D11	GND (FIXED)
C12	USB_SSRX3-	D12	USB_SSTX3-
C13	USB_SSRX3+	D13	USB_SSTX3+
C14	GND	D14	GND
C15	N/A	D15	DDI1_CTRLCLK_AUX+
C16	N/A	D16	DDI1_CTRLDATA_AUX-
C17	N/A	D17	N/A
C18	N/A	D18	N/A
C19	PCIE_RX6+	D19	PCIE_TX6+
C20	PCIE_RX6-	D20	PCIE_TX6-
C21	GND (FIXED)	D21	GND (FIXED)
C22	PCIE_RX7+	D22	PCIE_TX7+
C23	PCIE_RX7-	D23	PCIE_TX7-
C24	DDI1_HPD	D24	N/A
C25	N/A	D25	N/A
C26	N/A	D26	DDI1_PAIR0+

C27	N/A	D27	DDI1_PAIR0-
C28	N/A	D28	N/A
C29	N/A	D29	DDI1_PAIR1+
C30	N/A	D30	DDI1_PAIR1-
C31	GND (FIXED)	D31	GND (FIXED)
C32	DDI2_CTRLCLK_AUX+	D32	DDI1_PAIR2+
C33	DDI2_CTRLDATA_AUX-	D33	DDI1_PAIR2-
C34	DDI2_DDC_AUX_SEL	D34	DDI1_DDC_AUX_SEL
C35	N/A	D35	N/A
C36	DDI3_CTRLCLK_AUX+	D36	DDI1_PAIR3+
C37	DDI3_CTRLDATA_AUX-	D37	DDI1_PAIR3-
C38	DDI3_DDC_AUX_SEL	D38	N/A
C39	DDI3_PAIR0+	D39	DDI2_PAIR0+
C40	DDI3_PAIR0-	D40	DDI2_PAIR0-
C41	GND (FIXED)	D41	GND (FIXED)
C42	DDI3_PAIR1+	D42	DDI2_PAIR1+
C43	DDI3_PAIR1-	D43	DDI2_PAIR1-
C44	DDI3_HPD	D44	DDI2_HPD
C45	N/A	D45	N/A
C46	DDI3_PAIR2+	D46	DDI2_PAIR2+
C47	DDI3_PAIR2-	D47	DDI2_PAIR2-
C48	N/A	D48	N/A
C49	DDI3_PAIR3+	D49	DDI2_PAIR3+
C50	DDI3_PAIR3-	D50	DDI2_PAIR3-
C51	GND (FIXED)	D51	GND (FIXED)
C52	PEG_RX0+	D52	PEG_TX0+
C53	PEG_RX0-	D53	PEG_TX0-
C54	N/A	D54	PEG_LANE_RV#
C55	PEG_RX1+	D55	PEG_TX1+
C56	PEG_RX1-	D56	PEG_TX1-
C57	N/A	D57	TYPE2#
C58	PEG_RX2+	D58	PEG_TX2+
C59	PEG_RX2-	D59	PEG_TX2-
C60	GND (FIXED)	D60	GND (FIXED)
C61	PEG_RX3+	D61	PEG_TX3+
C62	PEG_RX3-	D62	PEG_TX3-
C63	N/A	D63	N/A
C64	N/A	D64	N/A
C65	PEG_RX4+	D65	PEG_TX4+
C66	PEG_RX4-	D66	PEG_TX4-
C67	N/A	D67	GND
C68	PEG_RX5+	D68	PEG_TX5+
C69	PEG_RX5-	D69	PEG_TX5-
C70	GND (FIXED)	D70	GND (FIXED)
C71	PEG_RX6+	D71	PEG_TX6+
C72	PEG_RX6-	D72	PEG_TX6-
C73	GND	D73	GND
C74	PEG_RX7+	D74	PEG_TX7+

C75	PEG_RX7-	D75	PEG_TX7-
C76	GND	D76	GND
C77	N/A	D77	N/A
C78	PEG_RX8+	D78	PEG_TX8+
C79	PEG_RX8-	D79	PEG_TX8-
C80	GND (FIXED)	D80	GND (FIXED)
C81	PEG_RX9+	D81	PEG_TX9+
C82	PEG_RX9-	D82	PEG_TX9-
C83	N/A	D83	N/A
C84	GND	D84	GND
C85	PEG_RX10+	D85	PEG_TX10+
C86	PEG_RX10-	D86	PEG_TX10-
C87	GND	D87	GND
C88	PEG_RX11+	D88	PEG_TX11+
C89	PEG_RX11-	D89	PEG_TX11-
C90	GND (FIXED)	D90	GND (FIXED)
C91	PEG_RX12+	D91	PEG_TX12+
C92	PEG_RX12-	D92	PEG_TX12-
C93	GND	D93	GND
C94	PEG_RX13+	D94	PEG_TX13+
C95	PEG_RX13-	D95	PEG_TX13-
C96	GND	D96	GND
C97	N/A	D97	PEG_ENABLE#
C98	PEG_RX14+	D98	PEG_TX14+
C99	PEG_RX14-	D99	PEG_TX14-
C100	GND (FIXED)	D100	GND (FIXED)
C101	PEG_RX15+	D101	PEG_TX15+
C102	PEG_RX15-	D102	PEG_TX15-
C103	GND	D103	GND
C104	VCC_12V	D104	VCC_12V
C105	VCC_12V	D105	VCC_12V
C106	VCC_12V	D106	VCC_12V
C107	VCC_12V	D107	VCC_12V
C108	VCC_12V	D108	VCC_12V
C109	VCC_12V	D109	VCC_12V
C110	GND (FIXED)	D110	GND (FIXED)

# Appendix **B**

## Watchdog Timer

This appendix gives you the information about the watchdog timer programming on the SOM-5897 CPU System on Module.

Sections include:

- Watchdog Timer Programming

---

## B.1 Programming the Watchdog Timer

Trigger Event	Note
IRQ	(BIOS setting default disable)**
NMI	N/A
SCI	Power button event
Power Off	Support
H/W Restart	Support
External WDT	N/A

\*\* WDT new driver support automatically selects available IRQ. Only Win XP, Win7 and Win8 support it.

In other OS, for details, please refer to iManager & Software API User Manual

# Appendix **C**

## Programming GPIO

This Appendix gives the illustration of the General Purpose Input and Output pin setting.

Sections include:

- System I/O Ports

---

## C.1 GPIO Register

GPIO Byte Mapping	H/W Pin Name
BIT0	GPO0
BIT1	GPO1
BIT2	GPO2
BIT3	GPO3
BIT4	GPI0
BIT5	GPI1
BIT6	GPI2
BIT7	GPI3

For details, please refer to *iManager & Software API User Manual*.

[Download Here!](#)



# Appendix **D**

## System Assignments

This appendix gives you the information about the system resource allocation on the SOM-5897 CPU System on Module.

Sections include:

- System I/O ports
- DMA Channel Assignments
- Interrupt Assignments
- 1st MB Memory Map

## D.1 System I/O Ports

**Table D.1: System I/O ports**

<b>Addr.Range(Hex)</b>	<b>Device</b>
0000-0CF7	PCI Express Root Complex
0020-0021	Programmable interrupt controller
0024-0025	Programmable interrupt controller
0028-0029	Programmable interrupt controller
002C-002D	Programmable interrupt controller
002E-002F	Motherboard resources
0030-0031	Programmable interrupt controller
0034-0035	Programmable interrupt controller
0038-0039	Programmable interrupt controller
003C-003D	Programmable interrupt controller
0040-0043	System timer
004E-004F	Motherboard resources
0050-0053	System timer
0060-0060	Standard PS/2 Keyboard
0061-0061	Motherboard resources
0062-0062	Microsoft ACPI-Compliant Embedded Controller
0063-0063	Motherboard resources
0064-0064	Standard PS/2 Keyboard
0065-0065	Motherboard resources
0066-0066	Microsoft ACPI-Compliant Embedded Controller
0067-0067	Motherboard resources
0070-0070	Motherboard resources
0070-0077	System CMOS/real time clock
0080-0080	Motherboard resources
0092-0092	Motherboard resources
00A0-00A1	Programmable interrupt controller
00A4-00A5	Programmable interrupt controller
00A8-00A9	Programmable interrupt controller
00AC-00AD	Programmable interrupt controller
00B0-00B1	Programmable interrupt controller
00B2-00B3	Motherboard resources
00B4-00B5	Programmable interrupt controller
00B8-00B9	Programmable interrupt controller
00BC-00BD	Programmable interrupt controller
00F0-00F0	Numeric data processor
029C-029D	Motherboard resources
02E8-02EF	Communications Port (COM4)
02F8-02FF	Communications Port (COM2)
0378-037F	Printer Port (LPT1)
03E8-03EF	Communications Port (COM3)
03F8-03FF	Communications Port (COM1)
04D0-04D1	Programmable interrupt controller
0680-069F	Motherboard resources

**Table D.1: System I/O ports**

0778-077F	Printer Port (LPT1)
0800-087F	Motherboard resources
0A00-0A0F	Motherboard resources
0A10-0A1F	Motherboard resources
0D00-FFFF	PCI Express Root Complex
164E-164F	Motherboard resources
1800-18FE	Motherboard resources
1854-1857	Motherboard resources
F000-F03F	Intel(R) HD Graphics 530
F040-F05F	Intel 100 Series/C230 Series Chipset Family SMBus – A123
F060-F07F	Intel 100 Series/C230 Series Chipset Family SATA AHCI Controller
F080-F083	Intel 100 Series/C230 Series Chipset Family SATA AHCI Controller
F090-F097	Intel 100 Series/C230 Series Chipset Family SATA AHCI Controller
FEF8-FEFF	Intel Active Management Technology – SOL (COM5)
FF00-FFFF	Motherboard resources
FFFF-FFFF	Motherboard resources

## D.2 DMA Channel Assignments

**Table D.2: DMA Channel Assignments**

Channel	Function
3	Printer Port (LPT1)

## D.3 Interrupt Assignments

**Table D.3: Interrupt Assignments**

Interrupt#	Interrupt Source
IRQ 0	System Timer
IRQ 1	Standard PS/2 Keyboard
IRQ 3	Communications Port (COM2)
IRQ 4	Communications Port (COM1)
IRQ 5	Communications Port (COM3)
IRQ 6	Communications Port (COM4)
IRQ 8	System CMOS/real time clock
IRQ 12	Microsoft PS/2 Mouse
IRQ 13	Numeric data processor
IRQ 14	Motherboard resources
IRQ 81~511	Microsoft ACPI-Compliant System
IRQ 11	Intel(R) 100 Series/C230 Series Chipset Family Thermal subsystem – A131
IRQ 11	Intel(R) 100 Series/C230 Series Chipset Family SMBus – A123
IRQ 16	High Definition Audio Controller
IRQ 19	Intel(R) Active Management Technology – SOL (COM5)

**Table D.3: Interrupt Assignments**

IRQ FFFFFFFFA (-6)	Intel(R) Management Engine Interface
IRQ FFFFFFFFB (-5)	Intel(R) USB 3.0 Host Controller Adaptation Driver
IRQ FFFFFFFFC (-4)	Intel(R) HD Graphics 530
IRQ FFFFFFFFD (-3)	Intel(R) Ethernet Connection (2) I219-LM
IRQ FFFFFFFFE (-2)	Intel(R) 100 Series/C230 Chipset Family SATA AHCI Controller

## D.4 1st MB Memory Map

**Table D.4: 1st MB Memory Map**

Addr. Range (Hex)	Device
0x000A0000-0x000BFFFF	PCI Express Root Complex
0x90000000-0xDFFFFFFF	PCI Express Root Complex
0xC0000000-0xCEFFFFFF	Intel(R) HD Graphics 530
0xDE000000-0xDEFFFFFF	Intel(R) HD Graphics 530
0xDF000000-0xDF01FFFF	Intel(R) I210 Ethernet Connection I219-LM
0xDF020000-0xDF02FFFF	High Definition Audio Controller
0xDF030000-0xDF03FFFF	Intel(R) USB 3.0 Host controller Adaptation Driver
0xDF040000-0xDF043FFF	High Definition Audio Controller
0xDF044000-0xDF047FFF	Intel(R) 100 Series/C230 Series Chipset Family PMC - A121
0xDF048000-0xDF049FFF	Intel(R) 100 Series/C230 Series Chipset Family SATA AHCI Controller
0xDF04A000-0xDF04A0FF	Intel(R) 100 Series/C230 Series Chipset Family SMBus - A123
0xDF04B000-0xDF04B7FF	Intel(R) 100 Series/C230 Series Chipset Family SATA AHCI Controller
0xDF04C000-0xDF04C0FF	Intel(R) 100 Series/C230 Series Chipset Family SATA AHCI Controller
0xDF04F000-0xDF04FFFF	Intel(R) 100 Series/C230 Series Chipset Family Thermal subsystem - A131
0xDFFE0000-0xDFFFFFFF	Motherboard resources
0xE0000000-0xEFFFFFFF	Motherboard resources
0xFD000000-0xFDABFFFF	Motherboard resources
0xFD000000-0xFE7FFFFF	PCI Express Root Complex
0xFDAC0000-0xFDACFFFF	Intel(R) Serial IO GPIO Host Controller - INT345D
0xFDAD0000-0xFDADFFFF	Motherboard resources
0xFDAE0000-0xFDAEFFFF	Intel(R) Serial IO GPIO Host Controller - INT345D
0xFDAF0000-0xFDAFFFFF	Intel(R) Serial IO GPIO Host Controller - INT345D
0xFDB00000-0xFDFFFFFF	Motherboard resources
0xFE000000-0xFE01FFFF	Motherboard resources
0xFE036000-0xFE03BFFF	Motherboard resources
0xFE03D000-0xFE3FFFFF	Motherboard resources
0xFE10000-0xFE1FFFFF	Intel(R) 100 Series/C230 Series Chipset Family Trace Hub - A126

Table D.4: 1st MB Memory Map	
0xFE20000-0xFE3FFFFFF	Intel(R) 100 Series/C230 Series Chipset Family Trace Hub - A126
0xFE40E000-0xFE40EFFF	Intel(R) Management Engine Interface
0xFE40F000-0xFE40FFFF	Intel(R) Active Management Technology - SOL (COM5)
0xFE410000-0xFE7FFFFFF	Motherboard resources
0xFED00000-0xFED003FF	High precision event timer
0xFED10000-0xFED17FFF	Motherboard resources
0xFED18000-0xFED18FFF	Motherboard resources
0xFED19000-0xFED19FFF	Motherboard resources
0xFED20000-0xFED3FFFF	Motherboard resources
0xFED45000-0xFED8FFFF	Motherboard resources
0xFED90000-0xFED93FFF	Motherboard resources
0xFEE00000-0xFEEFFFFFF	Motherboard resources
0xFF000000-0xFFFFFFFF	Intel(R) 82802 Firmware Hub Device
0xFF000000-0xFFFFFFFF	Motherboard resources

**ADVANTECH**

*Enabling an Intelligent Planet*

**[www.advantech.com](http://www.advantech.com)**

Please verify specifications before quoting. This guide is intended for reference purposes only.

All product specifications are subject to change without notice.

No part of this publication may be reproduced in any form or by any means, electronic, photocopying, recording or otherwise, without prior written permission of the publisher.

All brand and product names are trademarks or registered trademarks of their respective companies.

© Advantech Co., Ltd. 2018