

18 TURNS CERMET TRIMMERS

CT-94

RoHS compliant



FEATURES

- RoHS compliant
- Thin body design (4.8 mm thick)
- 18 turns, sealed, precision type

INTERNAL STRUCTURE

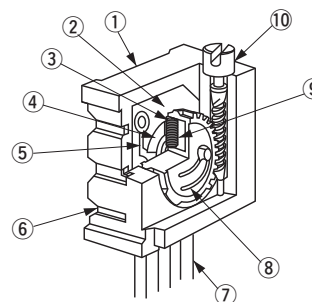

	Part name	Material	Flammability
①	Housing	Polybutyleneterephthalate	UL94V-0
②	Base element	Ceramic	—
③	Wiper	Multi metal alloy	
④	Resistive element	RuO ₂ cermet	
⑤	Electrode	Ag-Pd cermet	
⑥	Adhesive	Epoxy	UL94V-0
⑦	Terminal pin	Copper, Tin-plated	—
⑧	Rotor gear	Polyamide	UL94HB
⑨	Rubber cushion	Silicone rubber	—
⑩	Shaft	Brass, Nickel-plated	

PART NUMBER DESIGNATION

CT - 94 E W 1 k Ω (1 0 2)

Series name

Terminal pin

E : Sn (Lead-free)

Product shape

W, Y : Top adjustment

X, P, Z : Side adjustment

Resistance code







Resistance value

※ Please refer to the LIST OF PART NUMBERS when placing orders.

CT-94

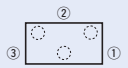
CERMET TRIMMERS

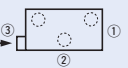
LIST OF PART NUMBERS

Adjustment position	Shape of terminal (Top view)	Form of packaging	Pieces in package
		Plastic bag	
Top adjustment 		CT-94EW	50 pcs./pack
		CT-94EY	
Side adjustment (↑ Adjustment direction)		CT-94EX	
		CP-94EP	
		CT-94EZ	
			

ELECTRICAL CHARACTERISTICS

Nominal resistance range	10 Ω ~ 2 MΩ
Resistance tolerance	± 10 %
Power ratings	0.5 W (70 °C) 0 W (125 °C)
Resistance law	(B) Linear law
Maximum input voltage	DC300 V or power rating, whichever is smaller
Maximum wiper current	100 mA or power rating, whichever is smaller
Effective electrical turn	15 turns
End resistance	1 % or 2 Ω, whichever is greater
C.R.V.	1 % or 3 Ω, whichever is greater
Operating temp. range	-55 ~ 125 °C
Temp. coefficient	10 Ω, 20 Ω : ± 250 10 ⁻⁶ /°C maximum 50 Ω ~ 2 MΩ : ± 100 10 ⁻⁶ /°C maximum
Insulation resistance	1000 MΩ minimum (DC500 V)
Dielectric strength	AC900 V, 60 s
Net weight	Approx. 0.88 g (CT-94EP) Approx. 0.92 g (CT-94EW, EX, EY, EZ)

<Nominal resistance values>

↻ 10 Ω	↻ 20 Ω	↻ 25 Ω	50 Ω	100 Ω	200 Ω	500 Ω	1 kΩ	2 kΩ	5 kΩ
10 kΩ	20 kΩ	25 kΩ	50 kΩ	100 kΩ	200 kΩ	↻ 250 kΩ	500 kΩ	1 MΩ	2 MΩ

Fig.1

※ The above part numbers are all available with the respective combination of <Nominal resistance values> (Fig. 1).

※ Verify the above part numbers when placing orders.

The products indicated by ↻ mark are manufactured upon receipt of order basis.

MECHANICAL CHARACTERISTICS

Mechanical turn	18 turns
Operating torque	35 mN·m {357 gf·cm} maximum
Mechanical stop	Clutch action
Rotational life	200 cycles [Δ R/R ≤ ± (2 Ω + 3 %)]
Terminal strength	10 N {1.02 kgf} minimum (Tensile strength)
Thrust to shaft	10 N {1.02 kgf} minimum
Solderability	245 ± 3 °C, 2 ~ 3 s

{ } : Reference only

ENVIRONMENTAL CHARACTERISTICS

Test item	Test conditions	Specifications
Thermal shock	-65 ~ 125 °C (0.5 h), 5 cycles	[Δ R/R ≤ 1 %] [S.S. ≤ 1 %]
Humidity	-10 ~ 65 °C (80 ~ 98 %), 10 cycles, 240 h	[Δ R/R ≤ 2 %]
Shock	981 m/s ² , 6 ms 6 directions for 3 times each	[Δ R/R ≤ 1 %] [S.S. ≤ 1 %]
Vibration	(Amplitude) 1.52 mm or (Acceleration) 196 m/s ² , 10 ~ 2000 Hz, 3 directions, 12 times each	
Load life	70 °C, 0.5 W, 1000 h	[Δ R/R ≤ 3 %] [S.S. ≤ 1 %]
Low temp. operation	-55 °C, 2 h	[Δ R/R ≤ 2 %] [S.S. ≤ 2 %]
High temp. exposure	125 °C, 250 h	[Δ R/R ≤ 3 %] [S.S. ≤ 2 %]
Immersion seal	85 °C, 60 s	No leaks (No continuous bubbles)
Soldering heat	Flow 260 ± 3 °C, 5 ~ 6 s, two times maximum Manual soldering 380 ± 10 °C, 3 ~ 4 s	[Δ R/R ≤ 1 %]

Δ R/R : Change in total resistance
S.S. : Setting stability

CT-94

CERMET TRIMMERS

MAXIMUM INPUT RATINGS

Nominal resistance values (Ω)	Resistance code	Maximum input voltage (V)	Maximum wiper current (mA)
<ul style="list-style-type: none"> ↻ 10 ↻ 20 50 100 200 500 	<ul style="list-style-type: none"> 100 200 500 101 201 501 	<ul style="list-style-type: none"> 1.00 2.00 5.00 7.07 10.0 15.8 	<ul style="list-style-type: none"> 100 100 100 70.7 50.0 31.6
<ul style="list-style-type: none"> 1 k 2 k 5 k 10 k 20 k ↻ 25 k 50 k 	<ul style="list-style-type: none"> 102 202 502 103 203 253 503 	<ul style="list-style-type: none"> 22.4 31.6 50.0 70.7 100 112 158 	<ul style="list-style-type: none"> 22.4 15.8 10.0 7.07 5.00 4.48 3.16
<ul style="list-style-type: none"> ↻ 100 k 200 k 250 k 500 k 1 M 2 M 	<ul style="list-style-type: none"> 104 204 254 504 105 205 	<ul style="list-style-type: none"> 224 300 300 300 300 300 	<ul style="list-style-type: none"> 2.24 1.50 1.20 0.60 0.30 0.15

The products indicated by ↻ mark are manufactured upon receipt of order basis.

OUTLINE DIMENSIONS

CT-94EW Top adjustment

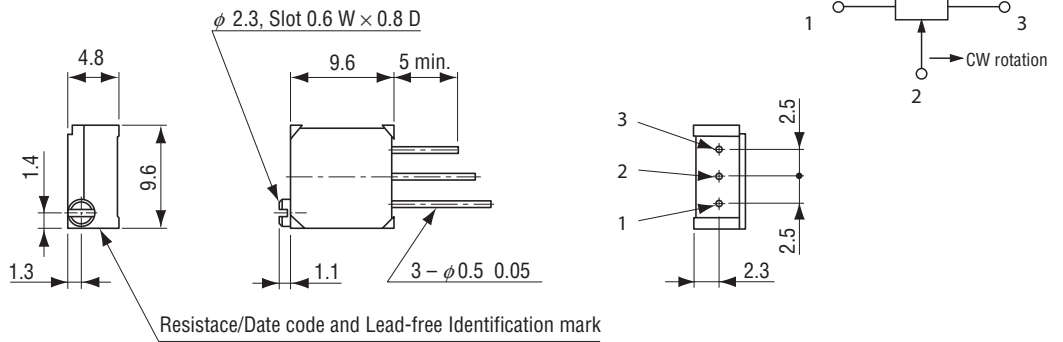

CT-94EX Side adjustment

