

Turbo 2 ultrafast high voltage rectifier

Datasheet - production data

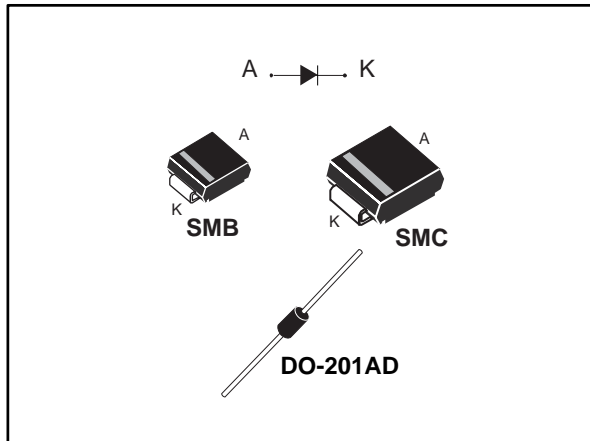

Features

- Ultrafast switching
- Low forward voltage drop
- Low thermal resistance
- Low leakage current (platinum doping)

Description

This device uses ST Turbo 2 600 V technology, and is particularly suited as boost diode in discontinuous or critical mode power factor corrections.

It is also intended for use as a freewheeling diode in power supplies and other power switching applications.

Table 1: Device summary

Symbol	Value
$I_{F(AV)}$	3 A
V_{RRM}	600 V
I_R (max.)	100 μ A
T_j (max.)	175 °C
V_F (typ.)	0.85 V
t_{rr} (typ.)	60 ns

Table 2: Order codes

Part number	Marking
STTH3L06	STTH3L06
STTH3L06U	3L6U
STTH3L06S	S06

1 Characteristics

Table 3: Absolute ratings (limiting values at 25 °C, unless otherwise specified)

Symbol	Parameter		Value	Unit	
V _{RRM}	Repetitive peak reverse voltage		600	V	
I _{F(RMS)}	Forward rms current		10	A	
I _{F(AV)}	Average forward current $\delta = 0.5$, square wave	DO-201AD/SMC	TI = 100 °C	3	A
		SMB	TI = 80 °C		
I _{FSM}	Surge non repetitive forward current, t _p = 10 ms sinusoidal	DO-201AD	70	A	
		SMB/SMC	60	A	
T _{stg}	Storage temperature range		-65 to +175	°C	
T _j	Maximum operating junction temperature		+175	°C	

Table 4: Thermal parameters

Symbol	Parameter		Maximum	Unit
R _{th(j-l)}	Junction to lead	DO-201AD L = 10 mm	20	°C/W
		SMB	25	
		SMC	20	
R _{th(j-a)}	Junction to ambient	DO-201AD L = 10 mm	75	

Table 5: Static electrical characteristics

Symbol	Parameter	Test conditions		Min.	Typ.	Max.	Unit
I _R	Reverse leakage current	T _j = 25 °C	V _R = V _{RRM}	-		3	μA
		T _j = 150 °C		-	15	100	
V _F	Forward voltage drop	T _j = 25 °C	I _F = 3 A	-		1.3	V
		T _j = 150 °C		-	0.85	1.05	

To evaluate the conduction losses use the following equation:

$$P = 0.89 \times I_{F(AV)} + 0.055 I_{F(RMS)}^2$$

Table 6: Dynamic characteristics

Symbol	Parameters	Test conditions		Min.	Typ.	Max.	Unit
t _{rr}	Reverse recovery time	T _j = 25 °C	I _F = 1 A; dI _F /dt = -50 A/μs; V _R = 30 V	-	60	85	ns
t _{fr}	Forward recovery time		I _F = 3 A; dI _F /dt = 100 A/μs; V _{FR} = 1.1 x V _{Fmax}	-		100	
V _{FP}	Forward recovery voltage	T _j = 25 °C	I _F = 3 A; dI _F /dt = 100 A/μs	-		7.5	V

1.1 Characteristics (curves)

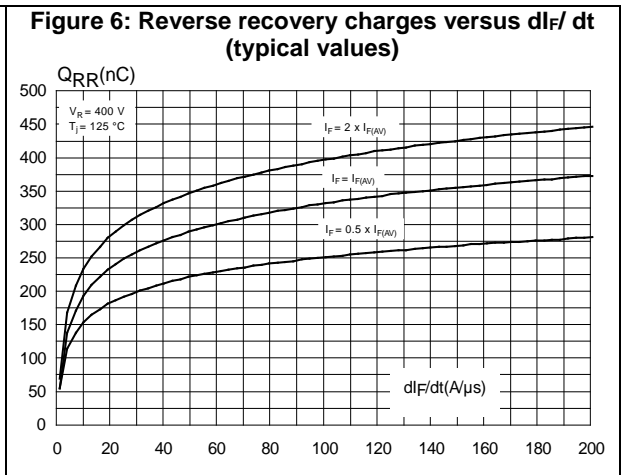
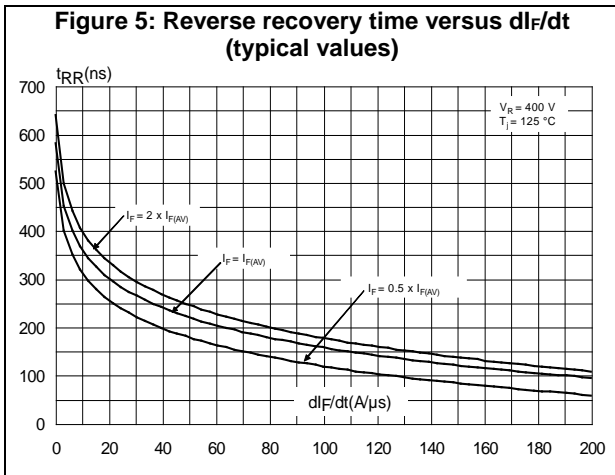
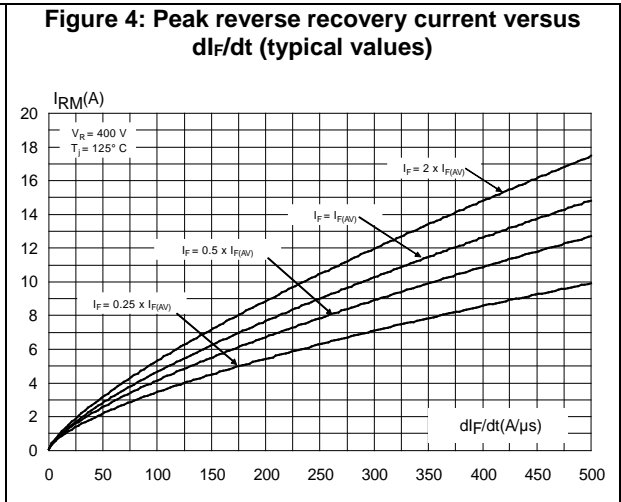
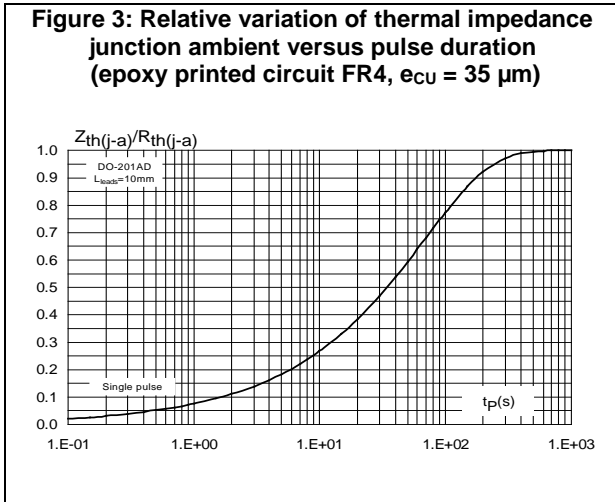
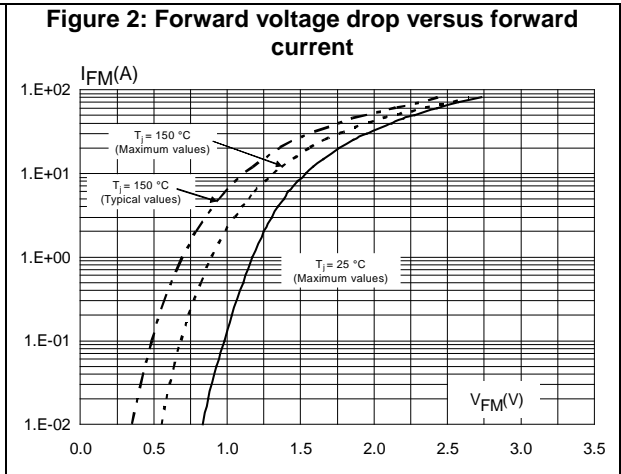
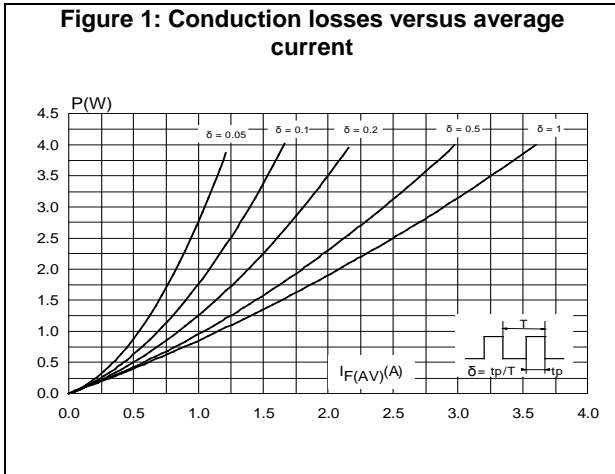

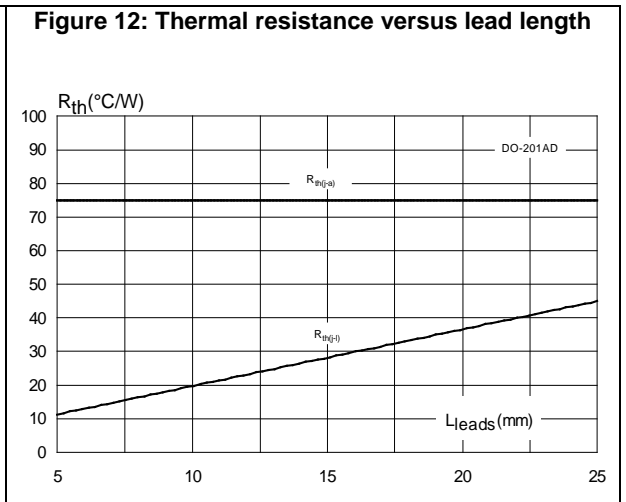
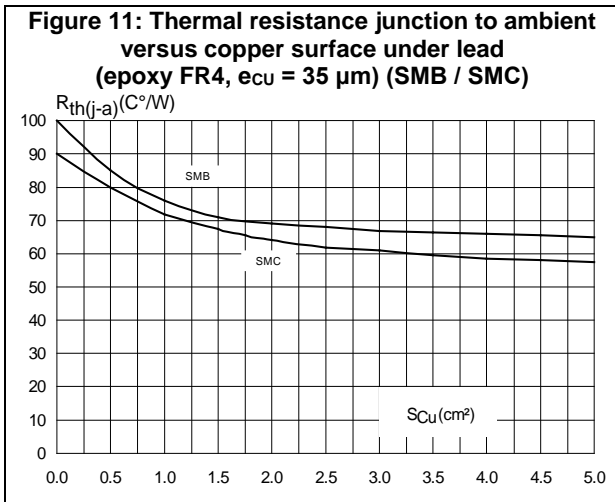
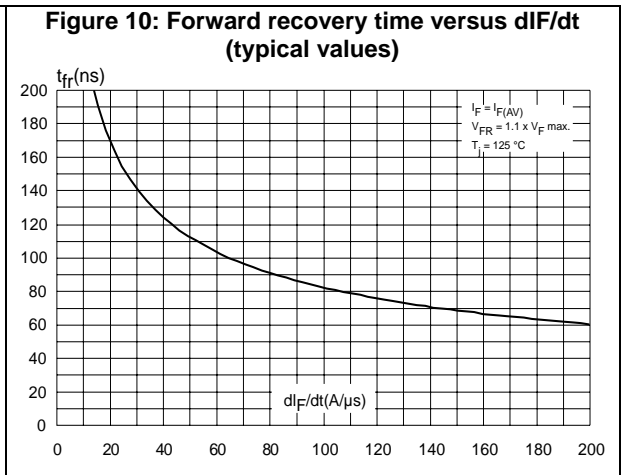
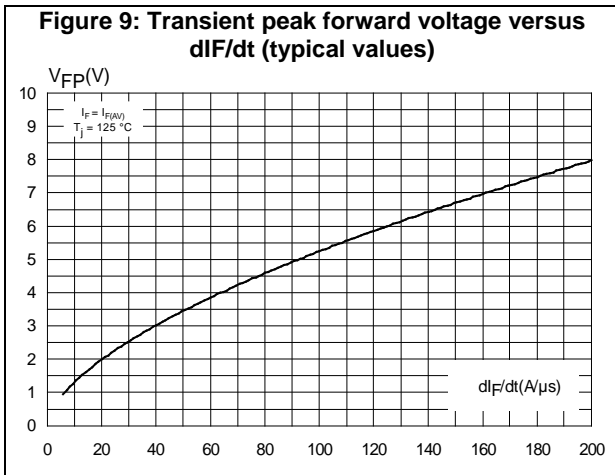
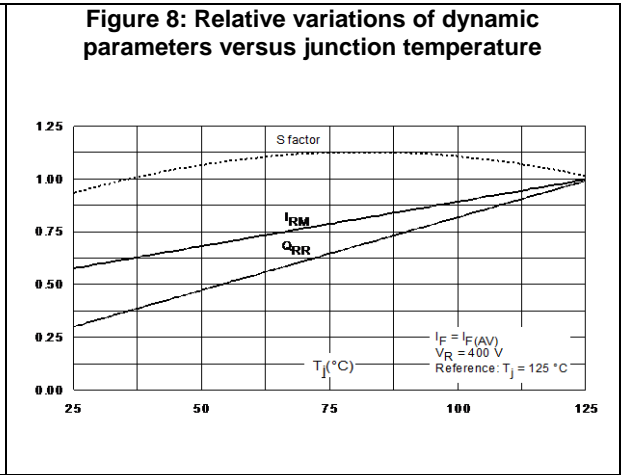
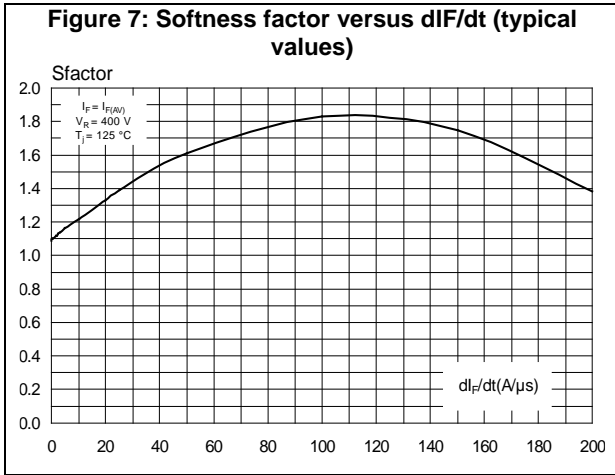

2 Package information

In order to meet environmental requirements, ST offers these devices in different grades of ECOPACK® packages, depending on their level of environmental compliance. ECOPACK® specifications, grade definitions and product status are available at: www.st.com. ECOPACK® is an ST trademark.

- Epoxy meets UL94, V0
- Band indicated cathode (DO-201AD)
- Bending method: see application note AN1471 (DO-201AD)

2.1 DO-201AD package information

Figure 13: DO-201AD package outline

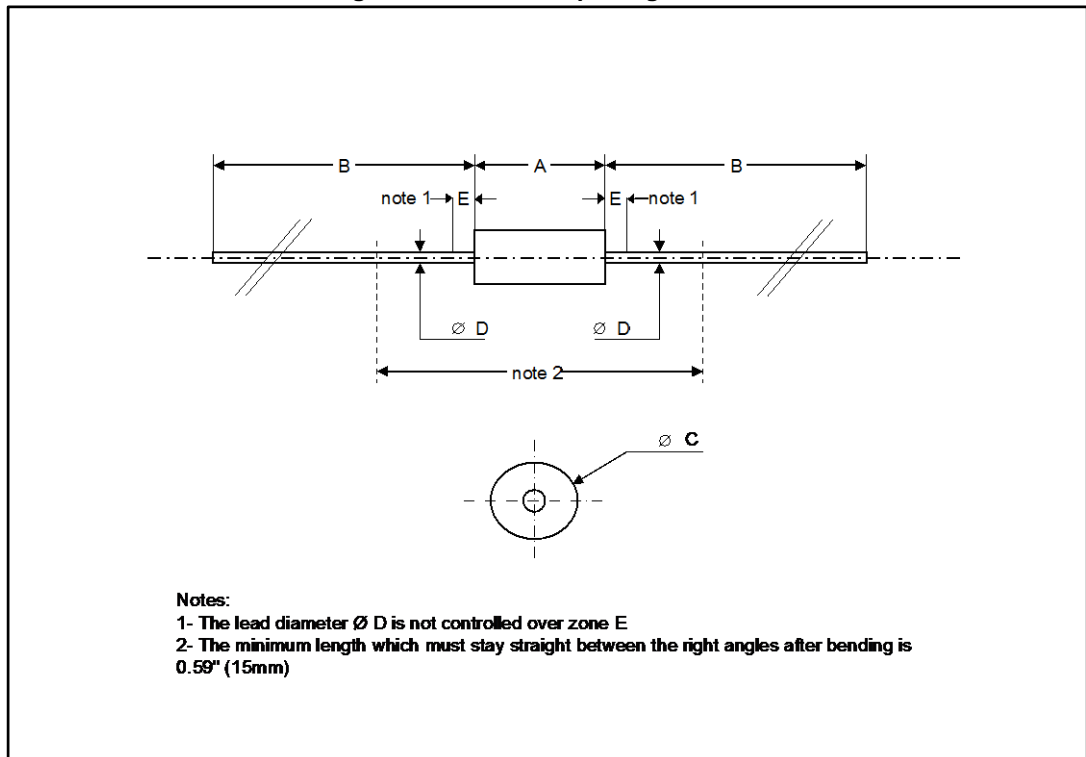

Table 7: DO-201AD package mechanical data

Ref.	Dimensions			
	Millimeters		Inches	
	Min.	Max.	Min.	Max.
A		9.5		0.3740
B	25.4		1.000	
C		5.3		0.2087
D		1.3		0.0512
E		1.25		0.0492

2.2 SMC package information

Figure 14: SMC package outline

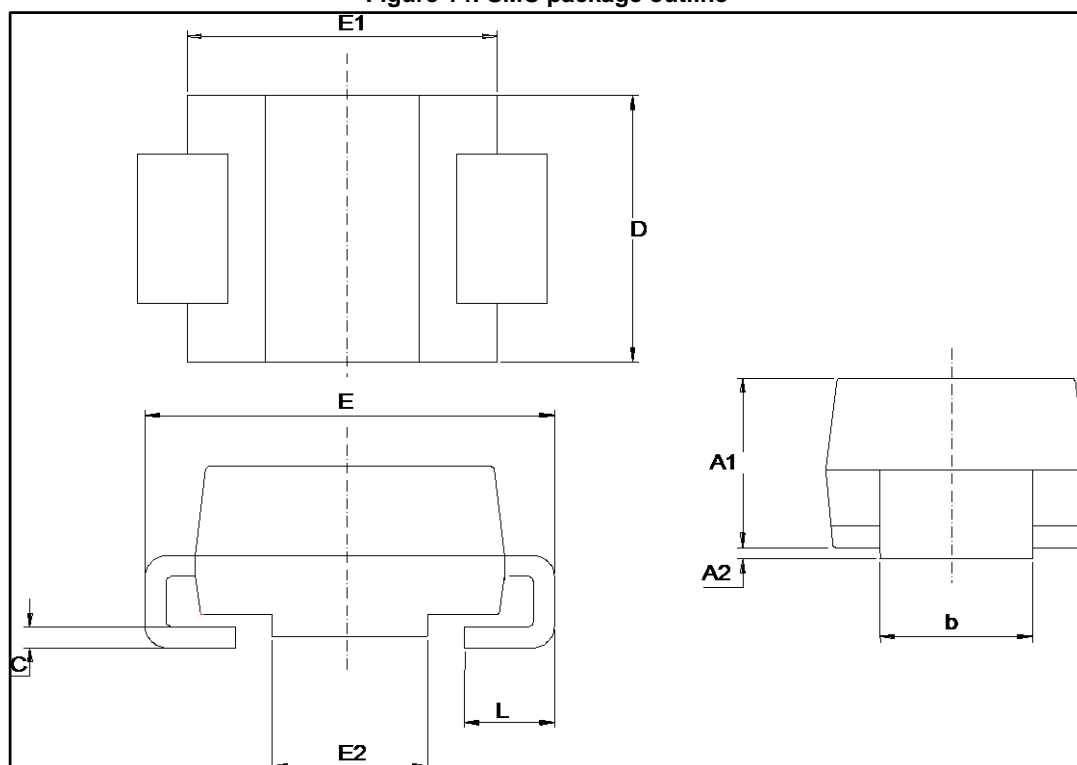
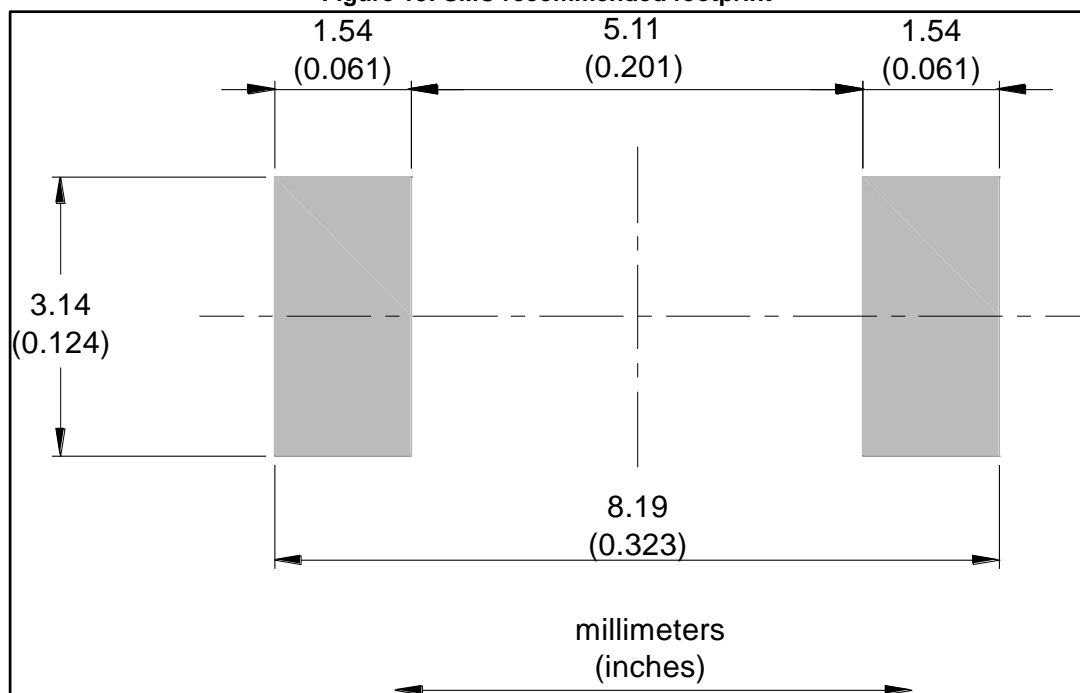

Table 8: SMC package mechanical data

Ref.	Dimensions			
	Millimeters		Inches	
	Min.	Max.	Min.	Max.
A1	1.90	2.45	0.0748	0.0965
A2	0.05	0.20	0.0020	0.0079
b	2.90	3.20	0.1142	0.1260
c	0.15	0.40	0.0059	0.0157
D	5.55	6.25	0.2185	0.2461
E	7.75	8.15	0.3051	0.3209
E1	6.60	7.15	0.2598	0.2815
E2	4.40	4.70	0.1732	0.1850
L	0.75	1.50	0.0295	0.0591

Figure 15: SMC recommended footprint



2.3 SMB package information

Figure 16: SMB package outline

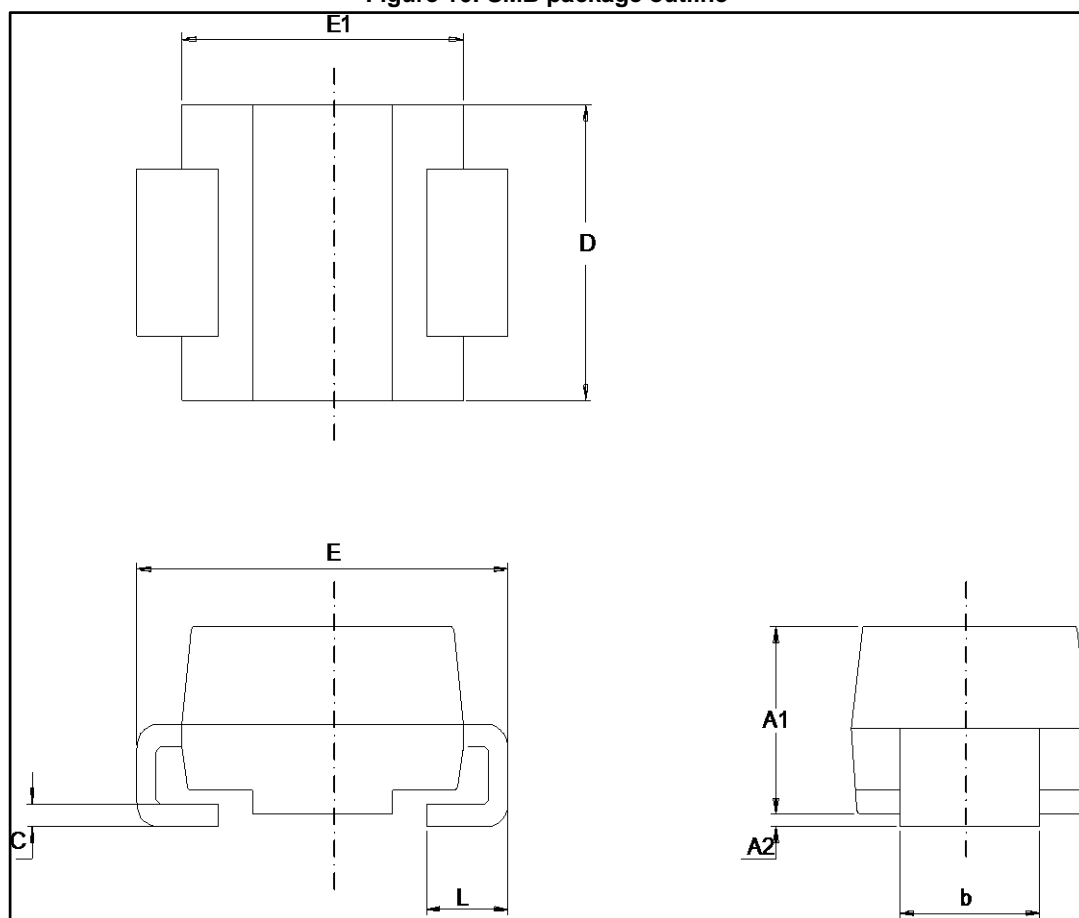
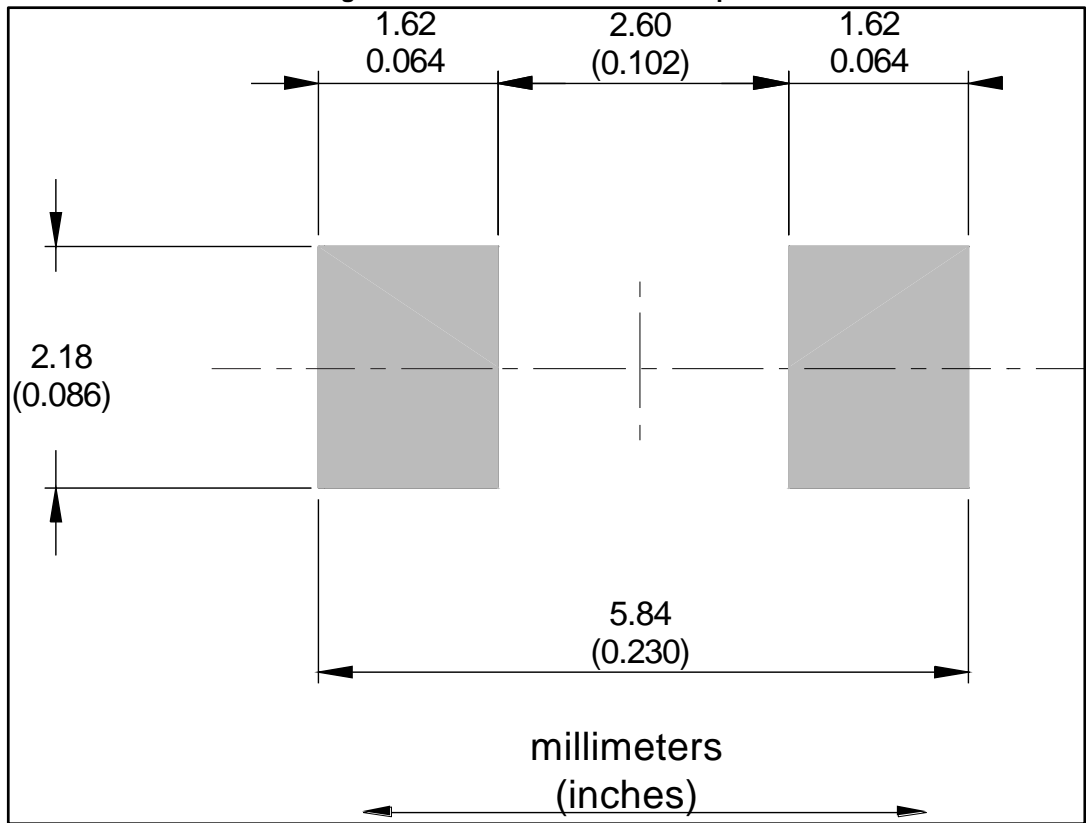

Table 9: SMB package mechanical data

Ref.	Dimensions			
	Millimeters		Inches	
	Min.	Max.	Min.	Max.
A1	1.90	2.45	0.0748	0.0965
A2	0.05	0.20	0.0020	0.0079
b	1.95	2.20	0.0768	0.0867
c	0.15	0.40	0.0059	0.0157
D	3.30	3.95	0.1299	0.1556
E	5.10	5.60	0.2008	0.2205
E1	4.05	4.60	0.1594	0.1811
L	0.75	1.50	0.0295	0.0591

Figure 17: SMB recommended footprint



3 Ordering information

Table 10: Ordering information

Order code	Marking	Package	Weight	Base qty.	Delivery mode
STTH3L06	STTH3L06	DO-201AD	1.12 g	600	Ammopack
STTH3L06-RL	STTH3L06			1900	Tape and reel
STTH3L06U	3L6U	SMB	0.11 g	2500	Tape and reel
STTH3L06S	S06	SMC	0.243 g	2500	Tape and reel

4 Revision history

Table 11: Document revision history

Date	Revision	Changes
October-2001	1	First issue
07-Sep-2004	2	SMB, SMC and DPAK packages added.
14-Oct-2005	3	Changed marking of STTH3L06U from 3L06U to 3L6U. Added ECOPACK statement.
29-Apr-2016	4	Removed DPAK package information. Minor text changes

IMPORTANT NOTICE – PLEASE READ CAREFULLY

STMicroelectronics NV and its subsidiaries ("ST") reserve the right to make changes, corrections, enhancements, modifications, and improvements to ST products and/or to this document at any time without notice. Purchasers should obtain the latest relevant information on ST products before placing orders. ST products are sold pursuant to ST's terms and conditions of sale in place at the time of order acknowledgement.

Purchasers are solely responsible for the choice, selection, and use of ST products and ST assumes no liability for application assistance or the design of Purchasers' products.

No license, express or implied, to any intellectual property right is granted by ST herein.

Resale of ST products with provisions different from the information set forth herein shall void any warranty granted by ST for such product.

ST and the ST logo are trademarks of ST. All other product or service names are the property of their respective owners.

Information in this document supersedes and replaces information previously supplied in any prior versions of this document.

© 2016 STMicroelectronics – All rights reserved