



## GaAs InGaP HBT MMIC BROADBAND AMPLIFIER GAIN BLOCK, DC - 6 GHz

### Typical Applications

Ideal as a Driver & Amplifier for:

- 2.2 - 2.7 GHz MMDS
- 3.5 GHz Wireless Local Loop
- 5 - 6 GHz UNII & HiperLAN

### Features

- P1dB Output Power: +14 dBm
- Output IP3: +27 dBm
- Gain: 17 dB
- Single Supply: +5V
- High Reliability GaAs HBT Process
- Ultra Small Package: SOT26
- Included in the HMC-DK001 Designer's Kit

### Functional Diagram

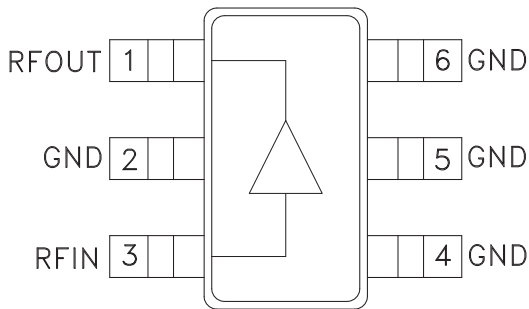

### General Description

The HMC313 & HMC313E are GaAs InGaP Heterojunction Bipolar Transistor (HBT) MMIC amplifiers that operate from a single Vcc supply. The surface mount SOT26 amplifier can be used as a broadband gain stage or used with external matching for optimized narrow band applications. With Vcc biased at +5V, the HMC313(E) offers 17 dB of gain and +15 dBm of saturated power while only requiring 50 mA of current.

### Electrical Specifications, $T_A = +25\text{ }^\circ\text{C}$ , $V_{CC} = +5.0V$

Parameter	Vcc = +5V			Units
	Min.	Typ.	Max.	
Frequency Range	DC - 6			GHz
Gain	14	17	20	dB
Gain Variation Over Temperature		0.02	0.03	dB/°C
Input Return Loss		7		dB
Output Return Loss		6		dB
Reverse Isolation		30		dB
Output Power for 1 dB Compression (P1dB) @ 1.0 GHz	11	14		dBm
Saturated Output Power (Psat) @ 1.0 GHz		15		dBm
Output Third Order Intercept (IP3) @ 1.0 GHz	24	27		dBm
Noise Figure		6.5		dB
Supply Current (Icc)		50		mA

Note: Data taken with broadband bias tee on device output.

Information furnished by Analog Devices is believed to be accurate and reliable. However, no responsibility is assumed by Analog Devices for its use, nor for any infringements of patents or other rights of third parties that may result from its use. Specifications subject to change without notice. No license is granted by implication or otherwise under any patent or patent rights of Analog Devices. Trademarks and registered trademarks are the property of their respective owners.

For price, delivery, and to place orders: Analog Devices, Inc., One Technology Way, P.O. Box 9106, Norwood, MA 02062-9106  
Phone: 781-329-4700 • Order online at [www.analog.com](http://www.analog.com)  
Application Support: Phone: 1-800-ANALOG-D

# HMC313\* PRODUCT PAGE QUICK LINKS

Last Content Update: 02/23/2017

---

## COMPARABLE PARTS

View a parametric search of comparable parts.

## EVALUATION KITS

- HMC313 Evaluation Board

## DOCUMENTATION

### Application Notes

- AN-1363: Meeting Biasing Requirements of Externally Biased RF/Microwave Amplifiers with Active Bias Controllers

### Data Sheet

- HMC313 Data Sheet

## TOOLS AND SIMULATIONS

- HMC313 S-Parameters

## REFERENCE MATERIALS

### Quality Documentation

- HMC Legacy PCN: SOT26 and SOT26E packages - Relocation of pre-existing production equipment to new building
- Package/Assembly Qualification Test Report: Plastic Encapsulated SOT26 (QTR: 02017 REV: 01)
- PCN: MS, QS, SOT, SOIC packages - Sn/Pb plating vendor change
- Semiconductor Qualification Test Report: GaAs HBT-B (QTR: 2013-00229)

## DESIGN RESOURCES

- HMC313 Material Declaration
- PCN-PDN Information
- Quality And Reliability
- Symbols and Footprints

## DISCUSSIONS

View all HMC313 EngineerZone Discussions.

## SAMPLE AND BUY

Visit the product page to see pricing options.

## TECHNICAL SUPPORT

Submit a technical question or find your regional support number.

## DOCUMENT FEEDBACK

Submit feedback for this data sheet.

---



**GaAs InGaP HBT MMIC BROADBAND  
AMPLIFIER GAIN BLOCK, DC - 6 GHz**

**Gain & Return Loss**

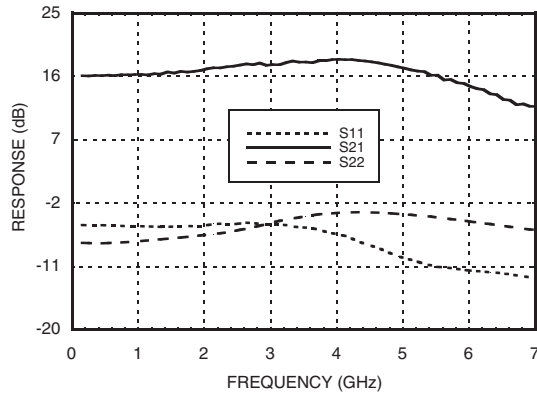

**Gain vs. Temperature**

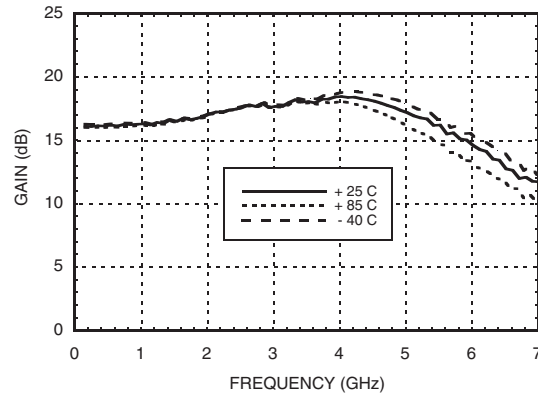

**Input & Output Return Loss**

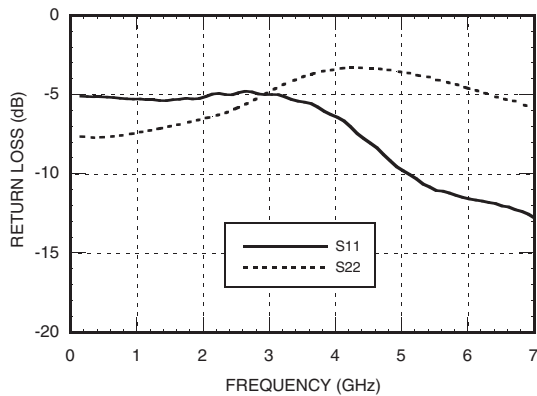

**Reverse Isolation**

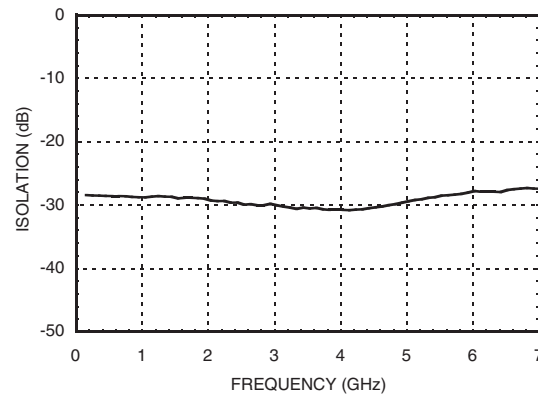

**P1dB vs. Temperature**

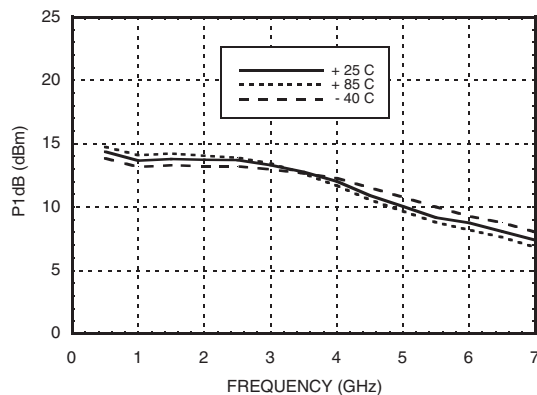

**Psat vs. Temperature**

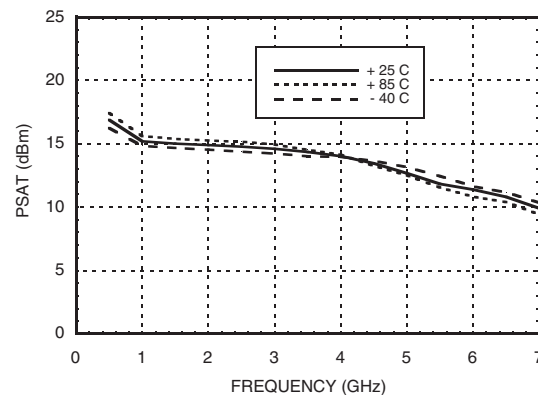

Information furnished by Analog Devices is believed to be accurate and reliable. However, no responsibility is assumed by Analog Devices for its use, nor for any infringements of patents or other rights of third parties that may result from its use. Specifications subject to change without notice. No license is granted by implication or otherwise under any patent or patent rights of Analog Devices. Trademarks and registered trademarks are the property of their respective owners.

For price, delivery, and to place orders: Analog Devices, Inc., One Technology Way, P.O. Box 9106, Norwood, MA 02062-9106 Phone: 781-329-4700 • Order online at [www.analog.com](http://www.analog.com) Application Support: Phone: 1-800-ANALOG-D



**GaAs InGaP HBT MMIC BROADBAND  
AMPLIFIER GAIN BLOCK, DC - 6 GHz**

9

DRIVER & GAIN BLOCK AMPLIFIERS - SMT

**Output IP3 vs. Temperature**

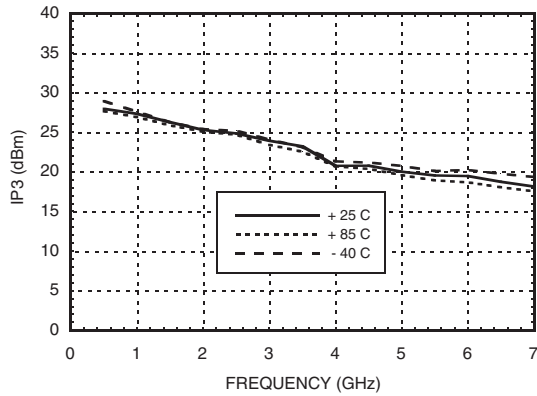

**Power Compression @ 1 GHz**

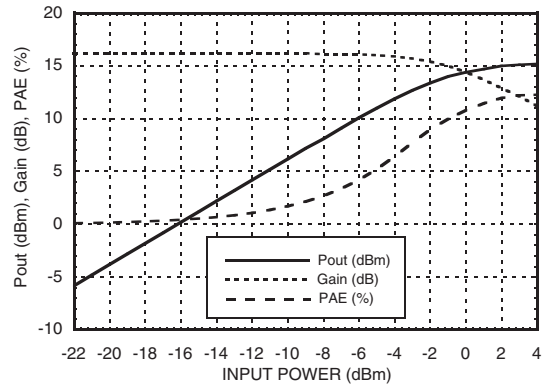

**Power Compression @ 3 GHz**

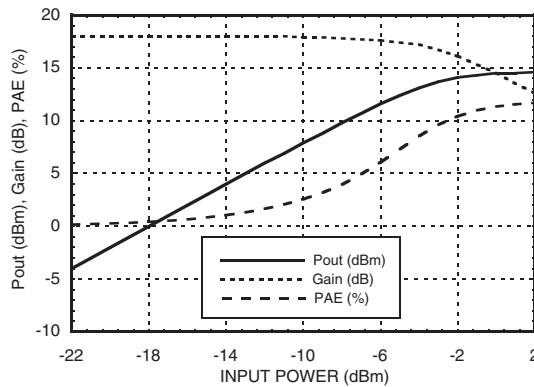

Information furnished by Analog Devices is believed to be accurate and reliable. However, no responsibility is assumed by Analog Devices for its use, nor for any infringements of patents or other rights of third parties that may result from its use. Specifications subject to change without notice. No license is granted by implication or otherwise under any patent or patent rights of Analog Devices. Trademarks and registered trademarks are the property of their respective owners.

For price, delivery, and to place orders: Analog Devices, Inc., One Technology Way, P.O. Box 9106, Norwood, MA 02062-9106 Phone: 781-329-4700 • Order online at [www.analog.com](http://www.analog.com) Application Support: Phone: 1-800-ANALOG-D

## GaAs InGaP HBT MMIC BROADBAND AMPLIFIER GAIN BLOCK, DC - 6 GHz



### Absolute Maximum Ratings

Collector Bias Voltage (Vcc)	+5.5 Vdc
RF Input Power (RFIN)(Vcc = +5Vdc)	+20 dBm
Junction Temperature	150 °C
Continuous P <sub>diss</sub> (T = 85 °C) (derate 3.99 mW/°C above 85 °C)	0.259 W
Thermal Resistance (junction to lead)	251 °C/W
Storage Temperature	-65 to +150 °C
Operating Temperature	-40 to +85 °C
ESD Sensitivity (HBM)	Class 1A



ELECTROSTATIC SENSITIVE DEVICE  
OBSERVE HANDLING PRECAUTIONS

### Outline Drawing

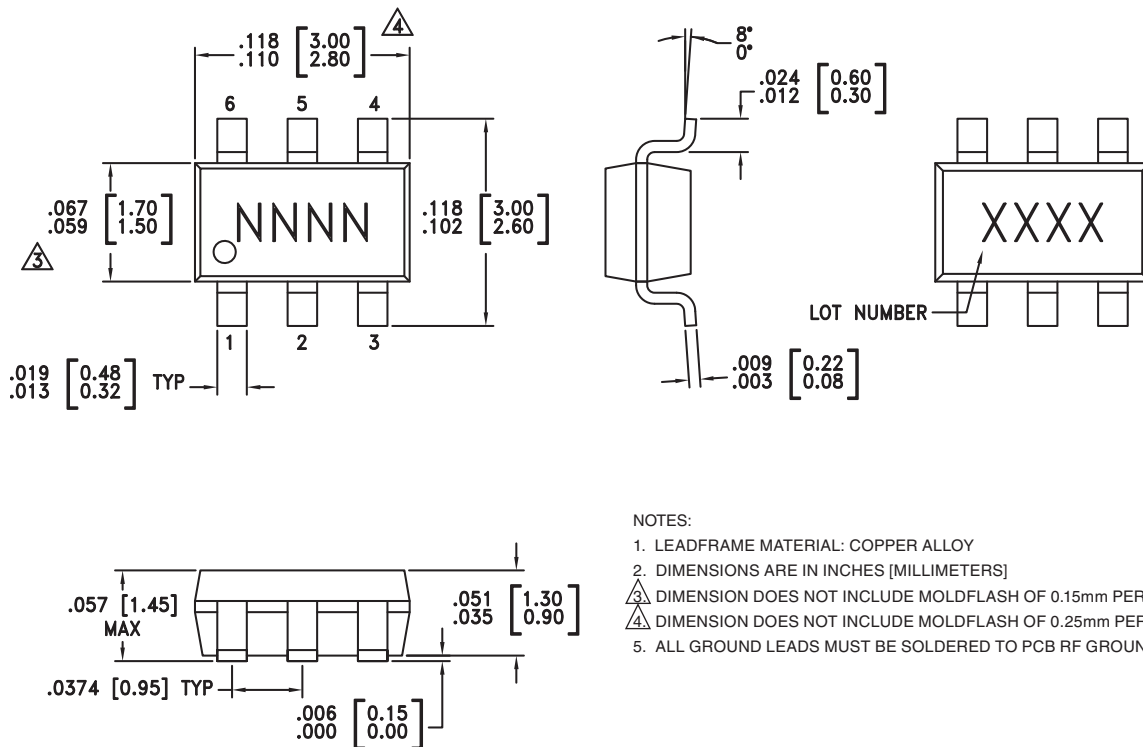

### Package Information

Part Number	Package Body Material	Lead Finish	MSL Rating	Package Marking <sup>[3]</sup>
HMC313	Low Stress Injection Molded Plastic	Sn/Pb Solder	MSL1 <sup>[1]</sup>	H313 XXXX
HMC313E	RoHS-compliant Low Stress Injection Molded Plastic	100% matte Sn	MSL1 <sup>[2]</sup>	313E XXXX

[1] Max peak reflow temperature of 235 °C

[2] Max peak reflow temperature of 260 °C

[3] 4-Digit lot number XXXX

## GaAs InGaP HBT MMIC BROADBAND AMPLIFIER GAIN BLOCK, DC - 6 GHz



### Pin Descriptions

Pin Number	Function	Description	Interface Schematic
1	RFOUT	This pin is DC coupled. An off chip DC blocking capacitor is required.	
3	RFIN	This pin is DC coupled. An off chip DC blocking capacitor is required.	
2, 4-6	GND	These pins must be connected to RF/DC ground.	

### Application Circuit

#### Recommended Bias Resistor Values for $I_{cc} = 50\text{ mA}$ , $R_{bias} = (V_s - 5.0) / I_{cc}$

Supply Voltage ( $V_s$ )	5V	6V	8V
RBIAS VALUE	0 $\Omega$	20 $\Omega$	62 $\Omega$
RBIAS POWER RATING		¼ W	½ W

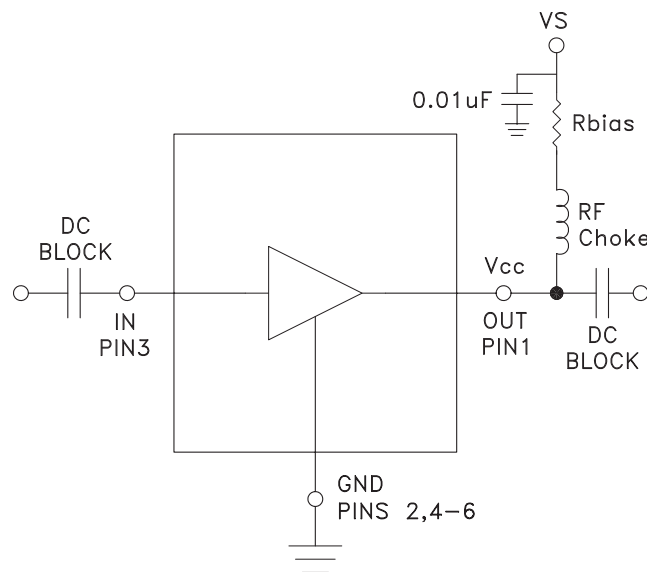

Note:

1. Select  $R_{bias}$  to achieve desired  $V_{cc}$  voltage on Pin 1.
2. External Blocking Capacitors are required on Pins 1 & 3.

## GaAs InGaP HBT MMIC BROADBAND AMPLIFIER GAIN BLOCK, DC - 6 GHz



### Evaluation PCB

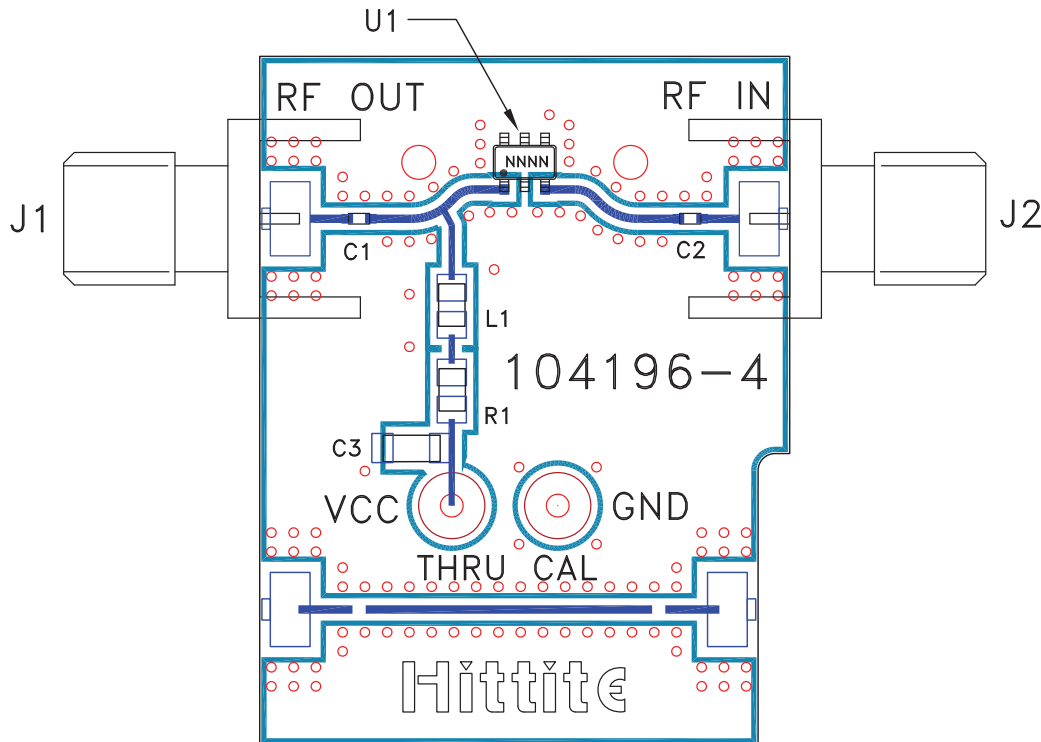

### List of Materials for Evaluation PCB 104217 [1]

Item	Description
J1 - J2	PCB Mount SMA Connector
C1 - C2	100 pF Capacitor, 0402 Pkg.
C3	100 pF Capacitor, 0805 Pkg.
L1	22 nH Inductor, 0805 Pkg.
R1	22 $\Omega$ Resistor, 0805 Pkg.
U1	HMC313 / HMC313E
PCB [2]	104196 Evaluation PCB

[1] Reference this number when ordering complete evaluation PCB

[2] Circuit Board Material: Arlon 25FR or Roger 4350

The circuit board used in the final application should use RF circuit design techniques. Signal lines should have 50 ohm impedance while the package ground leads should be connected directly to the ground plane similar to that shown. A sufficient number of via holes should be used to connect the top and bottom ground planes. The evaluation circuit board shown is available from Hittite upon request.