

LOC	DIST	REVISIONS					
AD	00	P	LTR	DESCRIPTION	DATE	DWN	APVD
		AA2		REVISED PER ECO-11-004917	11MAR11	RK	HMR

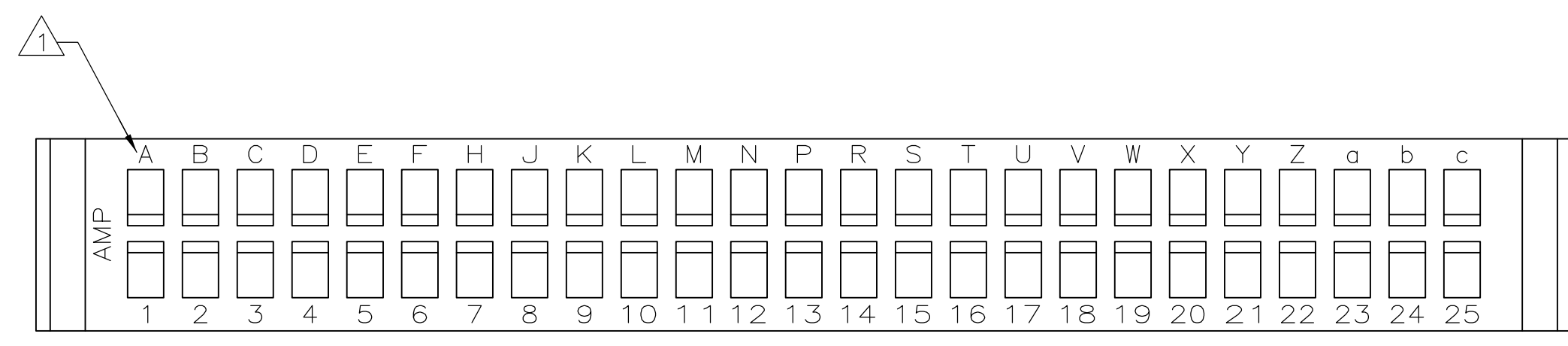

THIS DRAWING IS A CONTROLLED DOCUMENT FOR AMP INCORPORATED. IT IS SUBJECT TO CHANGE AND THE CONTROLLING ENGINEERING ORGANIZATION SHOULD BE CONTACTED FOR THE LATEST REVISION.

THIS DRAWING IS A CONTROLLED DOCUMENT.		DWN J. GALLUCCI BG	12-10-92	<b>STE</b> TE Connectivity
DIMENSIONS: MM(INCHES)		CHK H. ROSE	2/18/94	
TOLERANCES UNLESS OTHERWISE SPECIFIED:		APVD H. ROSE	2/18/94	NAME
0 PLC ± -		PRODUCT SPEC		HOUSING, CRIMP SNAP TWIN LEAF, .100 CL WITHOUT MOUNTING EARS
1 PLC ± -		APPLICATION SPEC		
2 PLC ± -		WEIGHT		
3 PLC ± 0.13 [.005]		SIZE		
4 PLC ± -		CAGE CODE		DRAWING NO.
ANGLES ± -		CUSTOMER DRAWING		SCALE
FINISH -		SHEET		1 OF 2
MATERIAL: GLASS FILLED POLYESTER COLOR: BLACK		REV		AA2

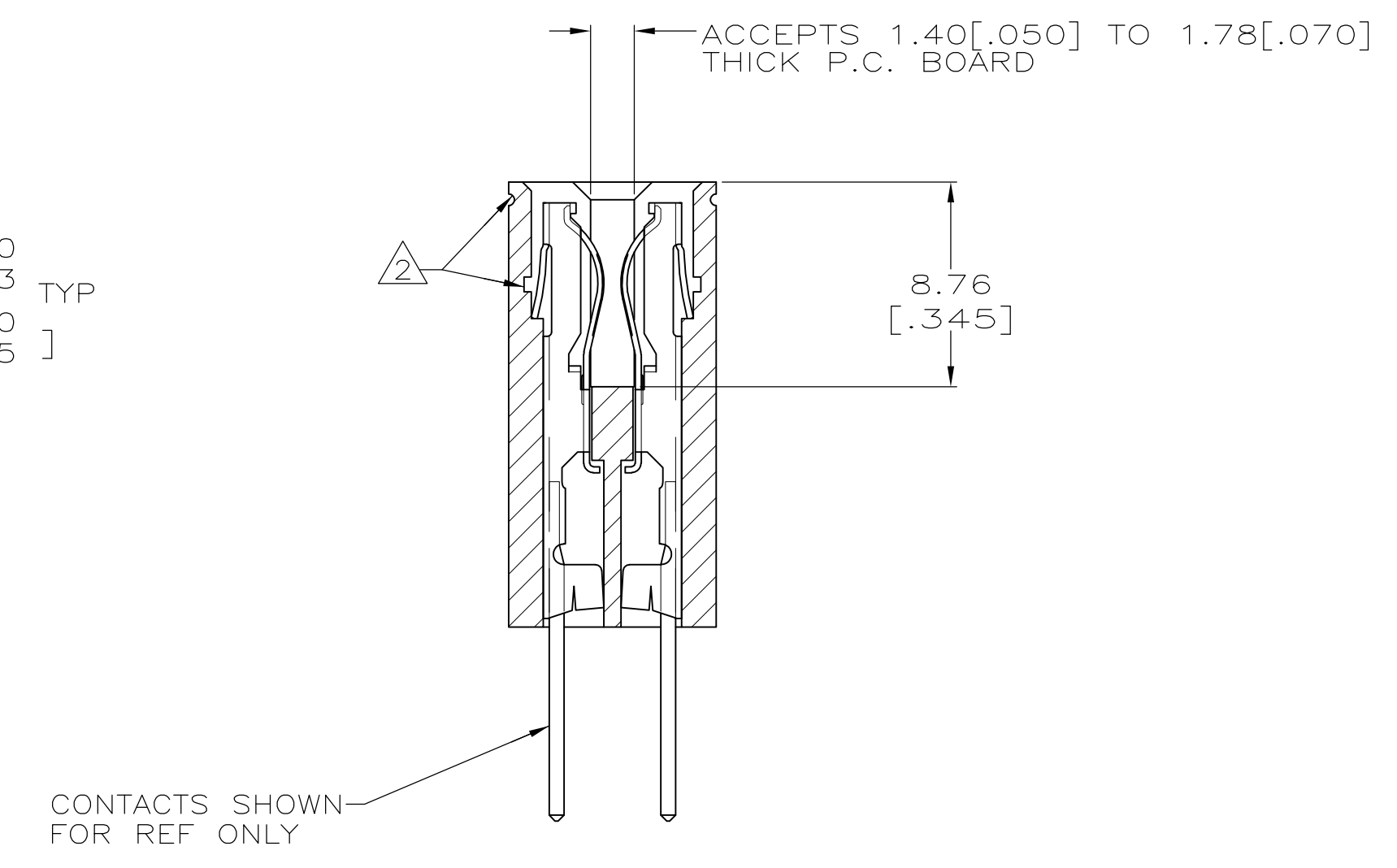
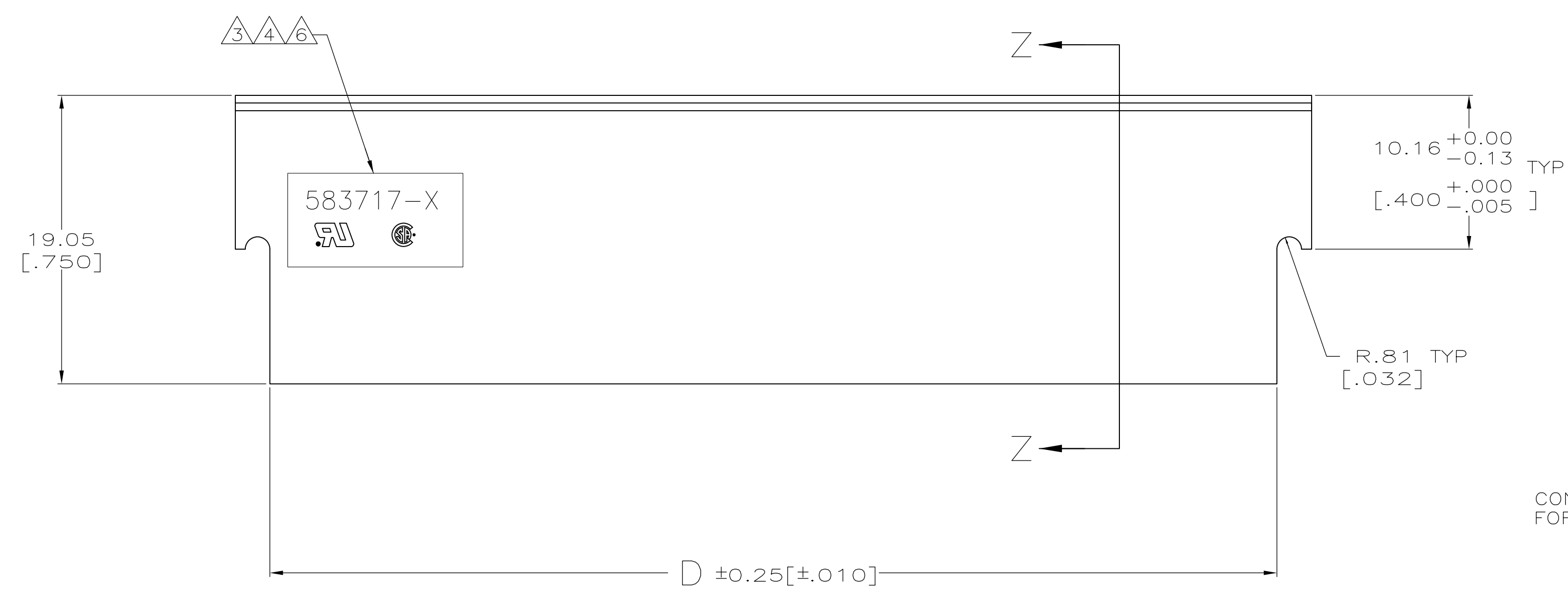
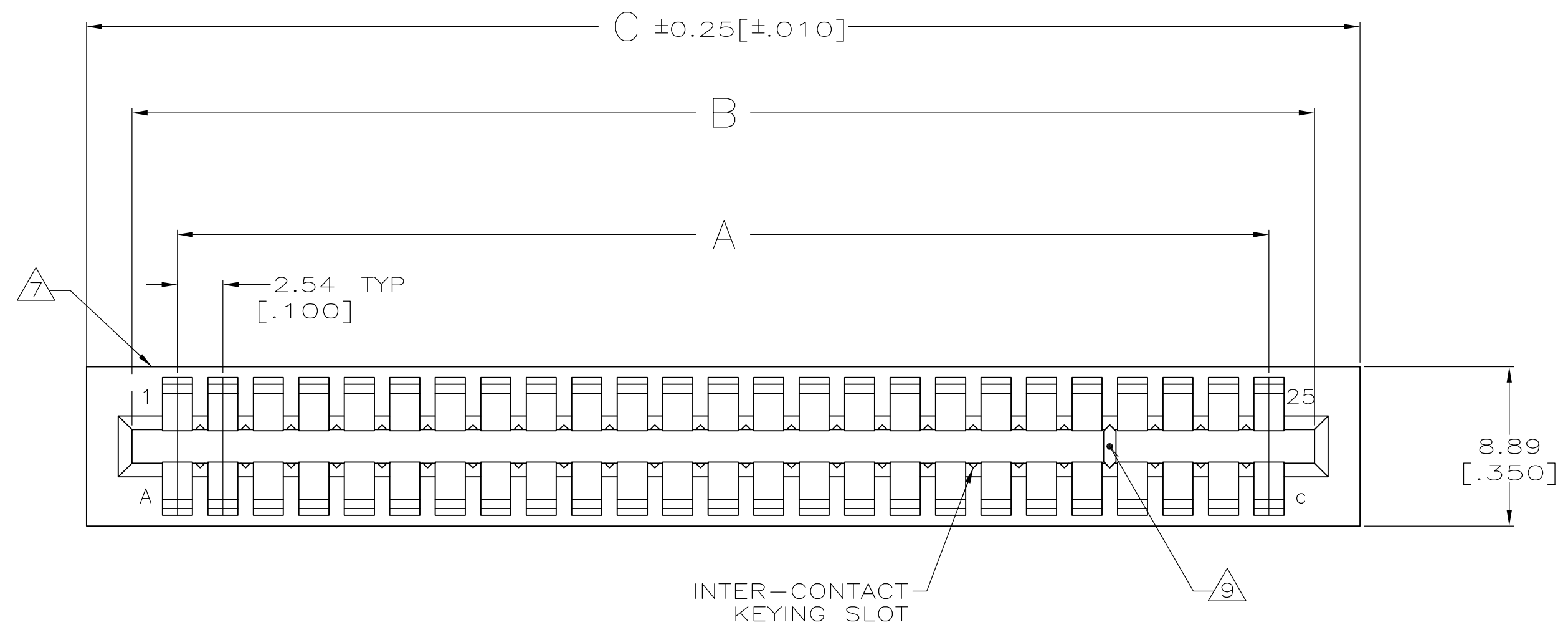
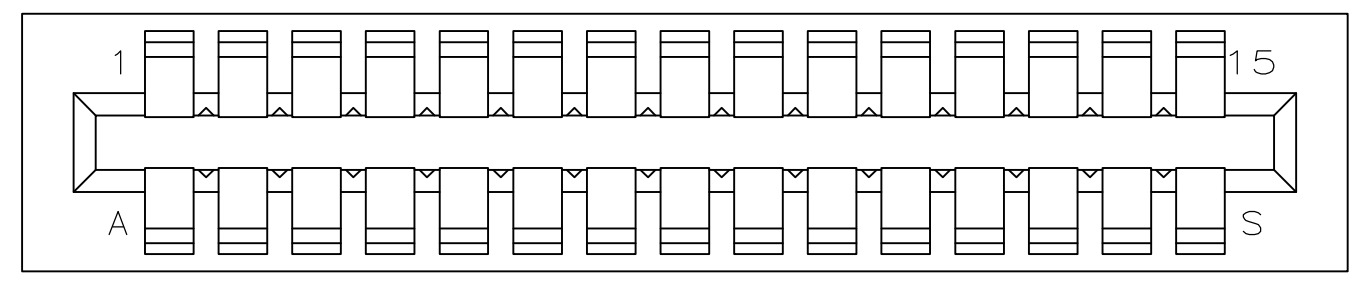
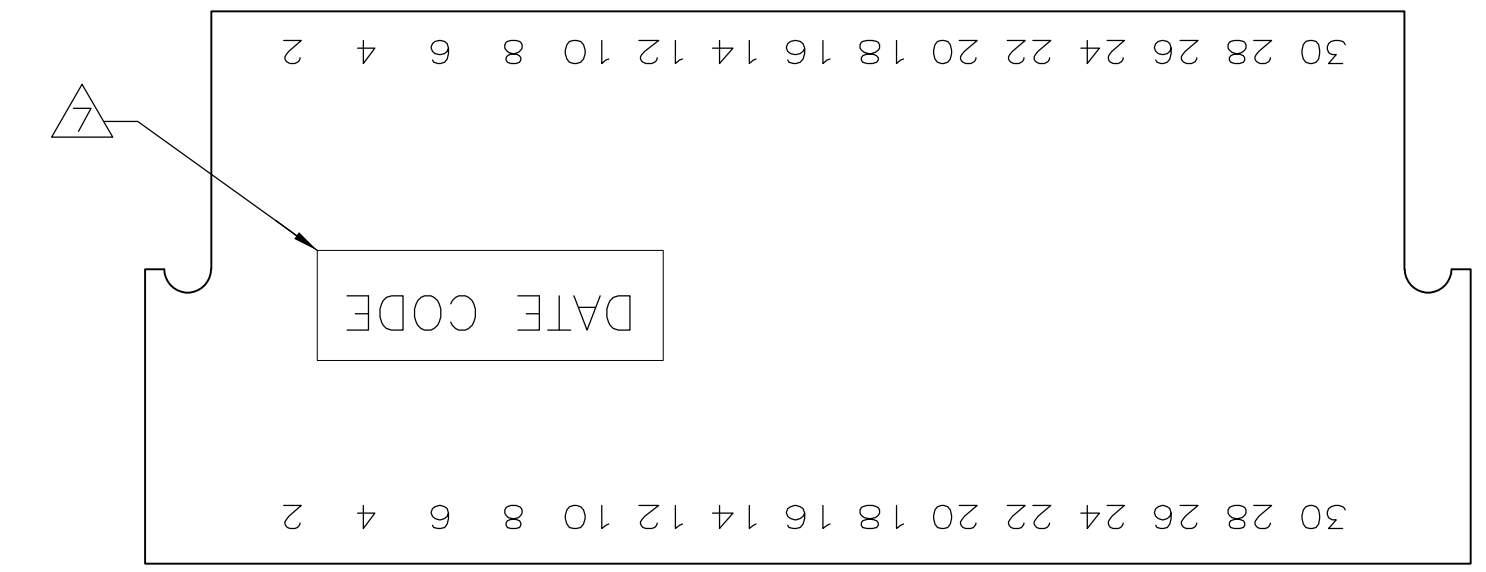

3-583717-4

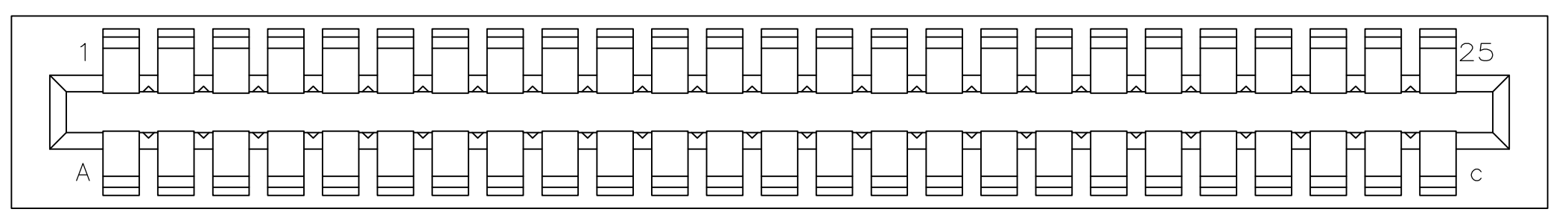
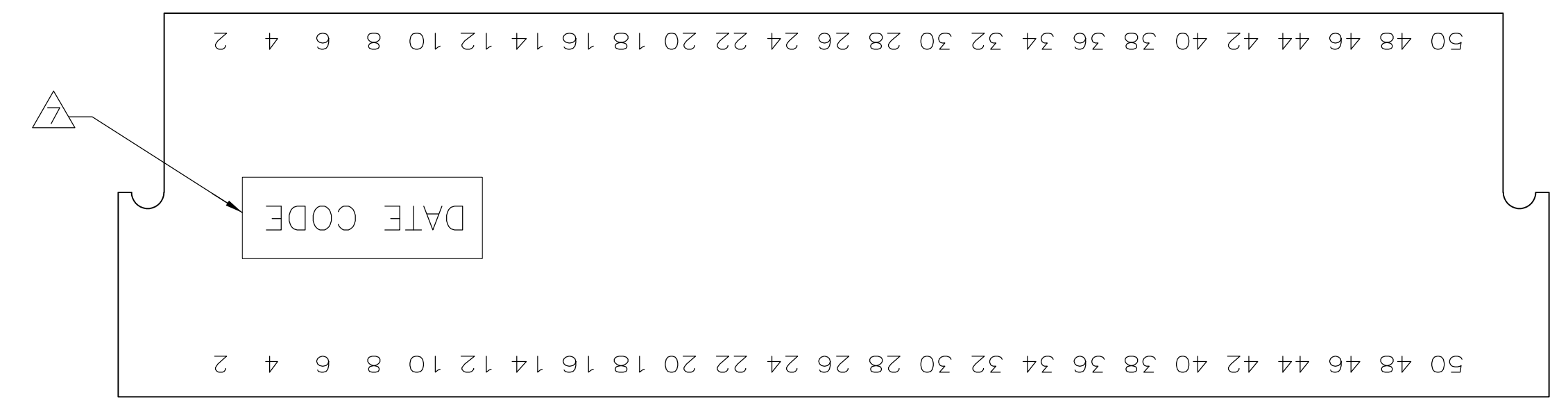
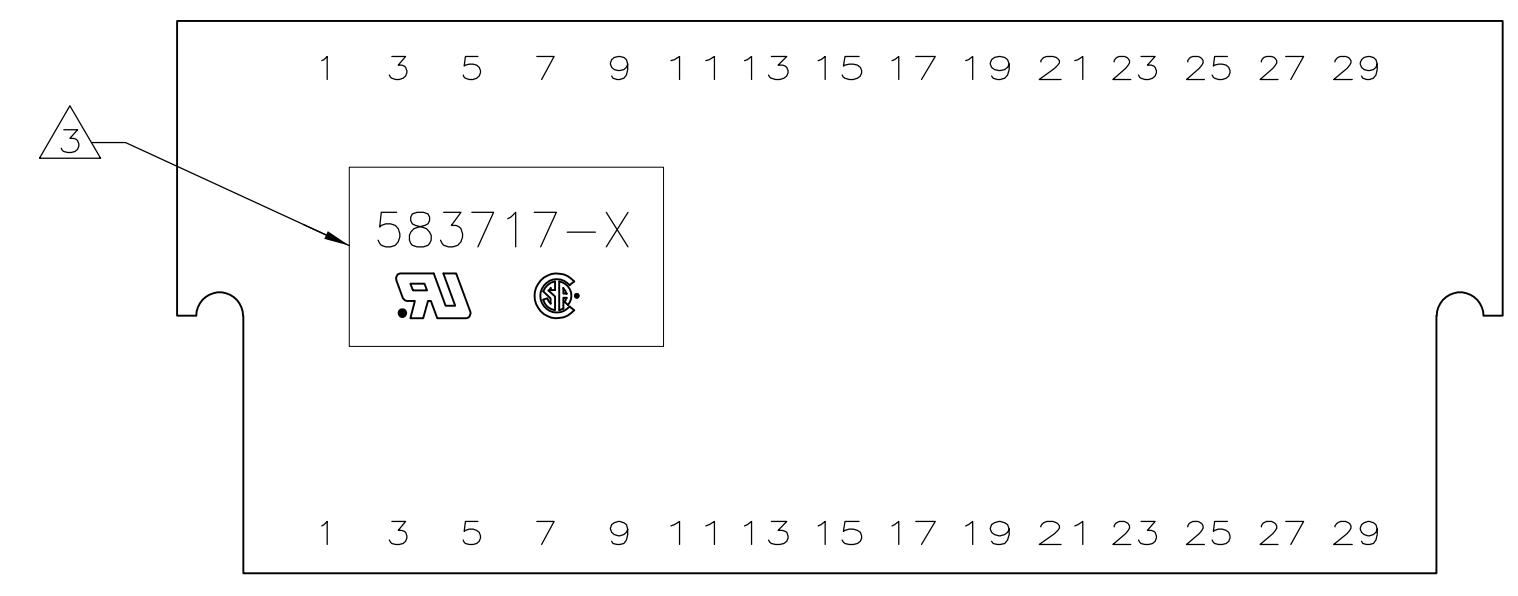

3-583717-5



- ① FIRST 22 POSITIONS MARKED WITH UPPER CASE LETTERS, FOLLOWED BY LOWER CASE LETTERS, FOLLOWED BY UPPERCASE AA,AB,AC ETC. CHARACTERS G,I,O AND Q ARE OMITTED. SEE TABLE FOR END CAVITY IDENTIFICATION.
- ② OPTIONAL PULL GROOVES. THE PULL GROOVE LENGTH, SIZE AND LOCATION ARE AT THE DISCRETION OF THE MOLD VENDOR.
- ③ HOUSING PART NUMBER, UL & CSA LOGO'S TO BE MOLDED IN THIS AREA. UL, LOGO PER 1-18838-3, CSA LOGO PER 1-18839-3.
- ④ HOT STAMP CUSTOMER PART NUMBER 2571 0880 FOR 2-583717-9 ONLY.
- ⑤ HOT STAMP CUSTOMER PART NUMBER 655862-2 IN THIS AREA.
- ⑥ DATE CODE TO BE MOLDED IN THIS AREA
- ⑦ MOLDED KEYING PLUG LOCATED BETWEEN CIRCUITS 25 AND 26 FOR PART NUMBER 4-583717-6 ONLY.
- ⑧ PRELIMINARY - NOT RELEASED FOR PRODUCTION.

⑨	3 & C	10.67 [.420]	15.24 [.600]	10.16 [.400]	5.08 [.200]	3	4-583717-8
⑨	23 & A	61.47 [2.420]	66.04 [2.600]	60.96 [2.400]	55.88 [2.200]	23	4-583717-7
⑧⑨	30 & J	79.25 [3.120]	83.82 [3.300]	78.74 [3.100]	73.66 [2.900]	30	4-583717-6
⑨	27 & E	71.63 [2.820]	76.20 [3.000]	71.12 [2.800]	66.04 [2.600]	27	4-583717-5
	8 & J	23.37 [.920]	27.94 [1.100]	22.86 [.900]	17.78 [.700]	8	3-583717-9
⑥	OBSOLETE 13 & P	36.07 [1.420]	40.64 [1.600]	35.56 [1.400]	30.48 [1.200]	13	3-583717-8
⑤	OBSOLETE 25 & e	66.55 [2.620]	71.12 [2.800]	66.04 [2.600]	60.96 [2.400]	25	3-583717-5
⑤	OBSOLETE 15 & S	41.15 [1.620]	45.72 [1.800]	40.64 [1.600]	35.56 [1.400]	15	3-583717-4
	13 & P	36.07 [1.420]	40.64 [1.600]	35.56 [1.400]	30.48 [1.200]	13	3-583717-3
	20 & X	53.85 [2.120]	58.42 [2.300]	53.34 [2.100]	48.26 [1.900]	20	3-583717-1
④	OBSOLETE 15 & S	41.15					
	14 & R	38.61					
	OBSOLETE 28 & f	74.17					
	7 & H	20.83 [.820]					
	6 & F	18.29 [.720]					
	50 & AF	130.05					
	OBSOLETE 40 & v	104.65					
	30 & j	79.25					
	25 & c	66.55					
		[2.320]	[2.500]	[2.300]	[2.100]		
	18 & V	48.77 [1.920]	53.34 [2.100]	48.26 [1.900]	43.18 [1.700]	18	583717-7
	17 & U	46.23 [1.820]	50.80 [2.000]	45.72 [1.800]	40.64 [1.600]	17	583717-5
	15 & S	41.15 [1.620]	45.72 [1.800]	40.64 [1.600]	35.56 [1.400]	15	583717-3
	10 & L	28.45 [1.120]	33.02 [1.300]	27.94 [1.100]	22.86 [.900]	10	583717-1
	END CAVITY IDENT	D	C	B	A	POSN	PART NUMBER

THIS DRAWING IS A CONTROLLED DOCUMENT FOR AMP INCORPORATED. IT IS SUBJECT TO CHANGE AND THE CONTROLLING ENGINEERING ORGANIZATION SHOULD BE CONTACTED FOR THE LATEST REVISION.

THIS DRAWING IS A CONTROLLED DOCUMENT.		OWN J. GALLUCCI 12-10-92	CHK H. ROSE 2/18/94	APVD H. ROSE 2/18/94	NAME	PART NO	
DIMENSIONS: MM(INCHES)		TOLERANCES UNLESS OTHERWISE SPECIFIED:		PRODUCT SPEC		TE Connectivity	
		0 PLC ±	1 PLC ±	2 PLC ±	3 PLC ±	4 PLC ±	ANGLES ±
MATERIAL		FINISH		APPLICATION SPEC		RESTRICTED TO	
				WEIGHT		SCALE	
				A1 00779		SHEET 2 OF 2	
				CUSTOMER DRAWING		REV AA2	