

LOC	DIST	REVISIONS			
P	LTR	DESCRIPTION	DATE	DWN	APVD
FT	0	D5	REVISED PER ECO-11-004820	11MAR2011	RK HMR

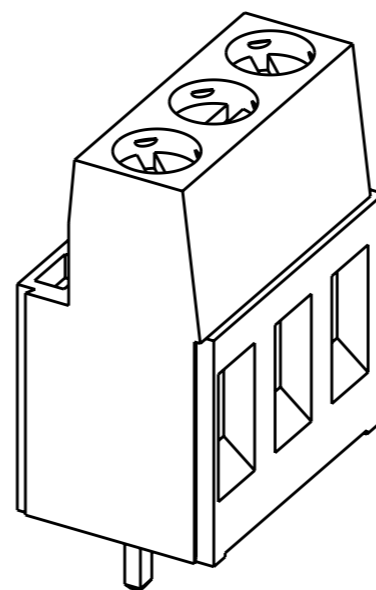

282856-3 AS SHOWN

COLOR	DIM. B	DIM. A	N° OF POS.	PART NUMBER
BLACK	7.0	10	2	2-282856-8
GREEN	7.0	10	2	2-282856-7
	4.5	10	2	2-282856-6
	3.5	125	25	2-282856-5
	3.5	120	24	2-282856-4
	3.5	115	23	2-282856-3
	3.5	110	22	2-282856-2
	3.5	105	21	2-282856-1
	3.5	100	20	2-282856-0
	3.5	95	19	1-282856-9
	3.5	90	18	1-282856-8
	3.5	85	17	1-282856-7
	3.5	80	16	1-282856-6
	3.5	75	15	1-282856-5
	3.5	70	14	1-282856-4
	3.5	65	13	1-282856-3
	3.5	60	12	1-282856-2
	3.5	55	11	1-282856-1
	3.5	50	10	1-282856-0
	3.5	45	9	282856-9
	3.5	40	8	282856-8
	3.5	35	7	282856-7
	3.5	30	6	282856-6
	3.5	25	5	282856-5
	3.5	20	4	282856-4
	3.5	15	3	282856-3
GREEN	3.5	10	2	282856-2

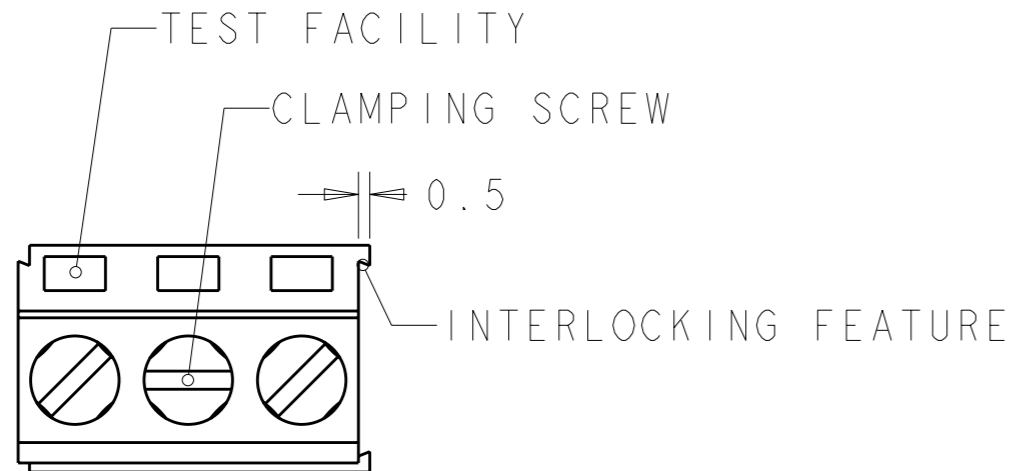
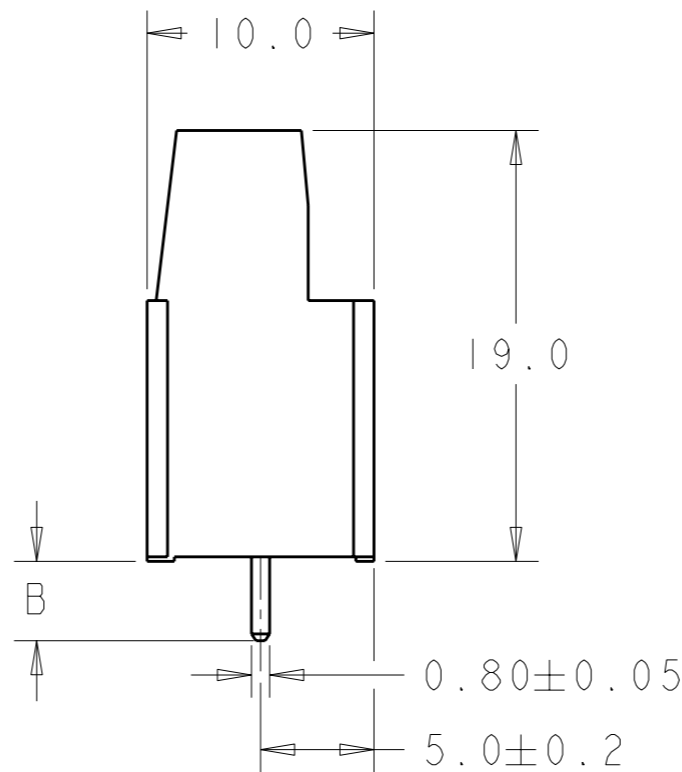
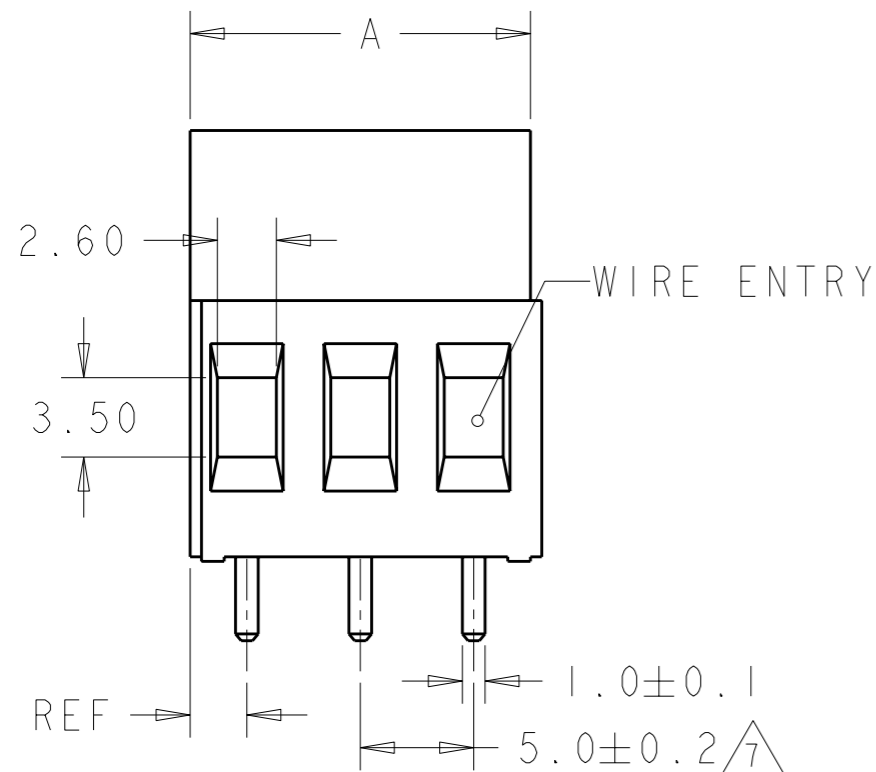

RECOMMENDED PC BOARD LAYOUT

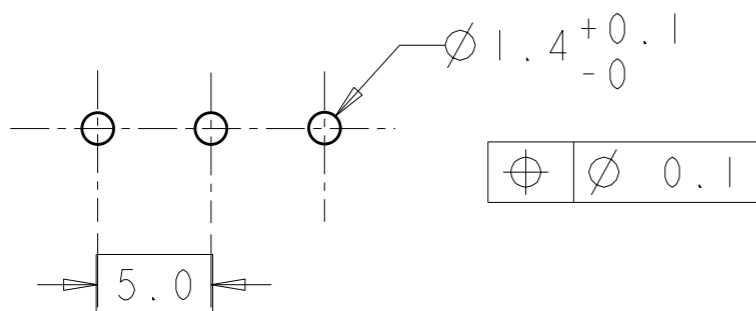

THIS DRAWING IS A CONTROLLED DOCUMENT.

DIMENSIONS: mm

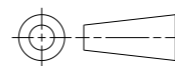

TOLERANCES UNLESS OTHERWISE SPECIFIED:

- 0 PLC ±.
- 1 PLC ±.3
- 2 PLC ±.25
- 3 PLC ±.
- 4 PLC ±.
- ANGLES ±2

MATERIAL



FINISH



DWN 23AUG2001

E. ZANOLINI

CHK 23AUG2001

D. BIEVENOUR

APVD 23AUG2001

D. BIEVENOUR

PRODUCT SPEC

108-20166

APPLICATION SPEC

114-20079

WEIGHT

-

CUSTOMER DRAWING

**STE** TE Connectivity

NAME  
TERMINAL BLOCK PCB MOUNT  
SIDE ENTRY WIRE, STACKING  
W/INTERLOCK, 5mm PITCH

SIZE	CAGE CODE	DRAWING NO	RESTRICTED TO
A3	00779	C-282856	-

SCALE 3:1 SHEET 1 OF 2 REV D5

THIS DRAWING IS UNPUBLISHED. RELEASED FOR PUBLICATION 20  
 © COPYRIGHT 20 BY - ALL RIGHTS RESERVED.

LOC	DIST	REVISIONS			
P	LTR	DESCRIPTION	DATE	DWN	APVD
		SEE SHEET 1	-	-	-

- 1 MATERIALS AND FINISH  
 HOUSING: PA 6-6, UL 94-V0, COLOR SEE TABLE.  
 CLAMP: BRASS, NICKEL PLATED.  
 TERMINAL: BRASS, TIN PLATED.  
 CLAMPING SCREW: M3, BRASS, NICKEL PLATED.
- 2 SUITABLE FOR 1,6-2,4mm PC BOARD THICKNESS.
- 3 END-TO-END STACKABLE W/INTERLOCK WITHOUT LOSS OF CENTERLINE SPACING.
- 4 WIRE SIZE RANGE  
 SOLID WIRE: 0,03-4mm<sup>2</sup> (11AWG).  
 STRANDED WIRE: 0,03-2,5mm<sup>2</sup> (13AWG).
- 5 RECOGNIZED UNDER THE COMPONENT PROGRAM OF UNDERWRITERS LABORATORIES INC. FILE N° E60677.
- 6 IMQ CERTIFICATE WITH SURVEILLANCE IN CONFORMITY WITH IEC 998-1/998-2-1.
- 7 NOT CUMULATIVE TOLERANCE.
- 8 PRELIMINARY PART NUMBER

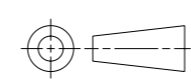
THIS DRAWING IS A CONTROLLED DOCUMENT.		DWN E. ZANOLINI 23AUG2001	 TE Connectivity		
DIMENSIONS: mm		CHK D. BIEVENOUR 23AUG2001			
		APVD D. BIEVENOUR 23AUG2001	NAME TERMINAL BLOCK PCB MOUNT SIDE ENTRY WIRE, STACKING W/INTERLOCK, 5mm PITCH		
TOLERANCES UNLESS OTHERWISE SPECIFIED: 0 PLC ±- 1 PLC ±.2 2 PLC ±.15 3 PLC ±- 4 PLC ±- ANGLES ±2		PRODUCT SPEC -	RESTRICTED TO -		
MATERIAL - FINISH -		APPLICATION SPEC -	SIZE A3	CAGE CODE 00779	DRAWING NO C-282856
		WEIGHT -	SCALE 3:1		
		CUSTOMER DRAWING	SHEET 2 OF 2 REV D5		