

SERIES 34A Miniature Toggle Switches

FEATURES

- Save Space and Weight
- SPDT, DPDT, 3PDT, and 4PDT Circuitry
- Choice of Actuators, Bushings and Terminations
- UL Recognized

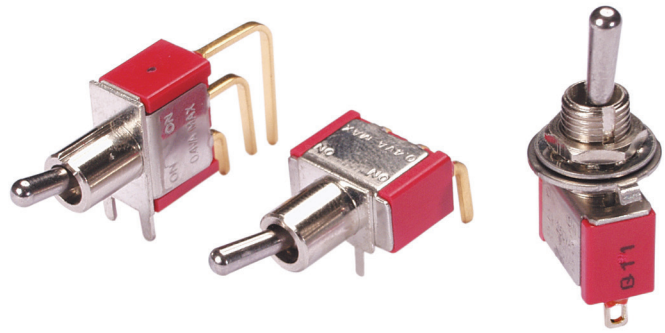

MODELS in inches (and millimeters)

SPDT

MODEL NO.	SWITCH POSITION		
	ON	NONE	ON
SP1	ON	NONE	ON
SP2	ON	NONE	(ON)
SP3	ON	OFF	ON
SP4	(ON)	OFF	(ON)
SP5	ON	OFF	(ON)
TERM. COMM.	2-3,5-6 8-9	OPEN	2-1,5-4 8-7

()=MOMENTARY

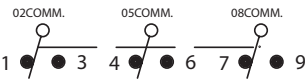

SCHEMATIC

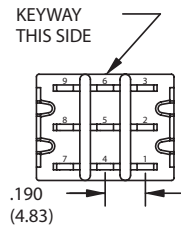
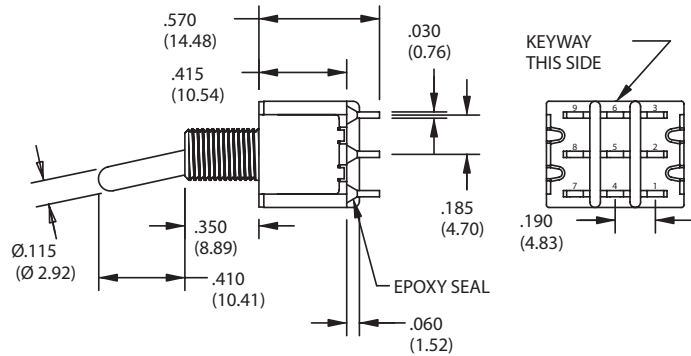
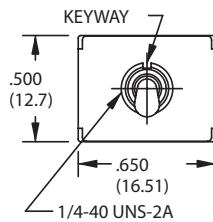

DPDT

MODEL NO.	SWITCH POSITION		
	ON	NONE	ON
DP1	ON	NONE	ON
DP2	ON	NONE	(ON)
DP3	ON	OFF	ON
DP4	(ON)	OFF	(ON)
DP5	ON	OFF	(ON)
TERM. COMM.	2-3, 5-6	OPEN	2-1, 5-4

()=MOMENTARY



SCHEMATIC

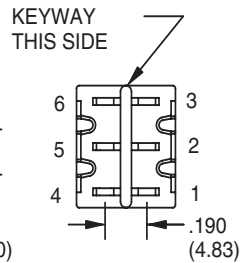
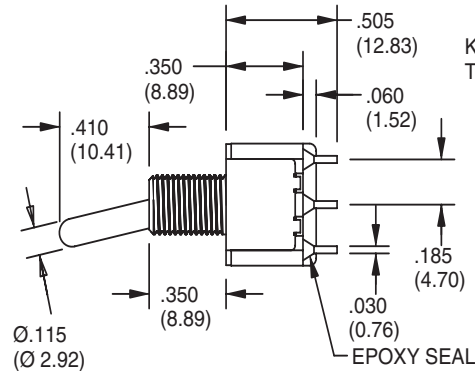
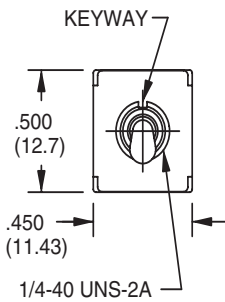

3PDT

MODEL NO.	SWITCH POSITION		
	ON	NONE	ON
SP1	ON	NONE	ON
SP2	ON	NONE	(ON)
SP3	ON	OFF	ON
SP4	(ON)	OFF	(ON)
SP5	ON	OFF	(ON)
TERM. COMM.	2-3,5-6 8-9	OPEN	2-1,5-4 8-7

()=MOMENTARY

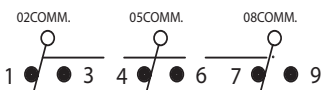

SCHEMATIC

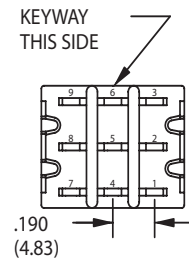
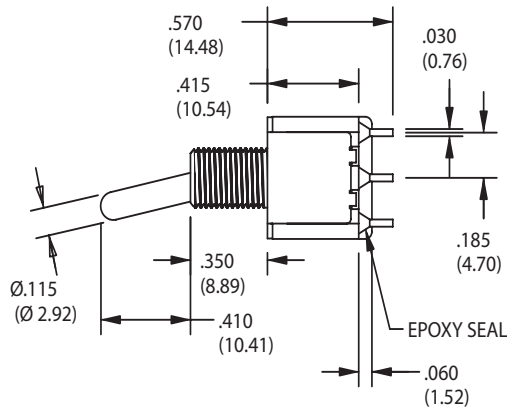
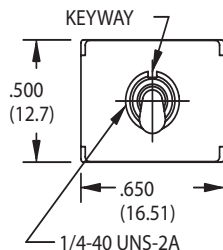

MODELS in inches (and millimeters)

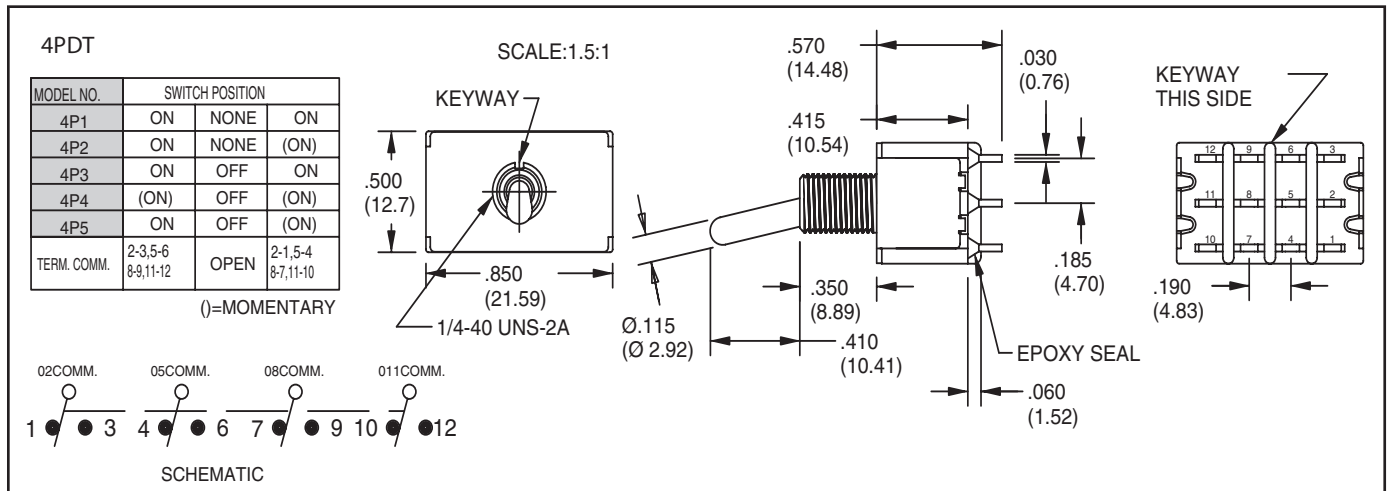

ACTUATOR OPTIONS in inches (and millimeters)

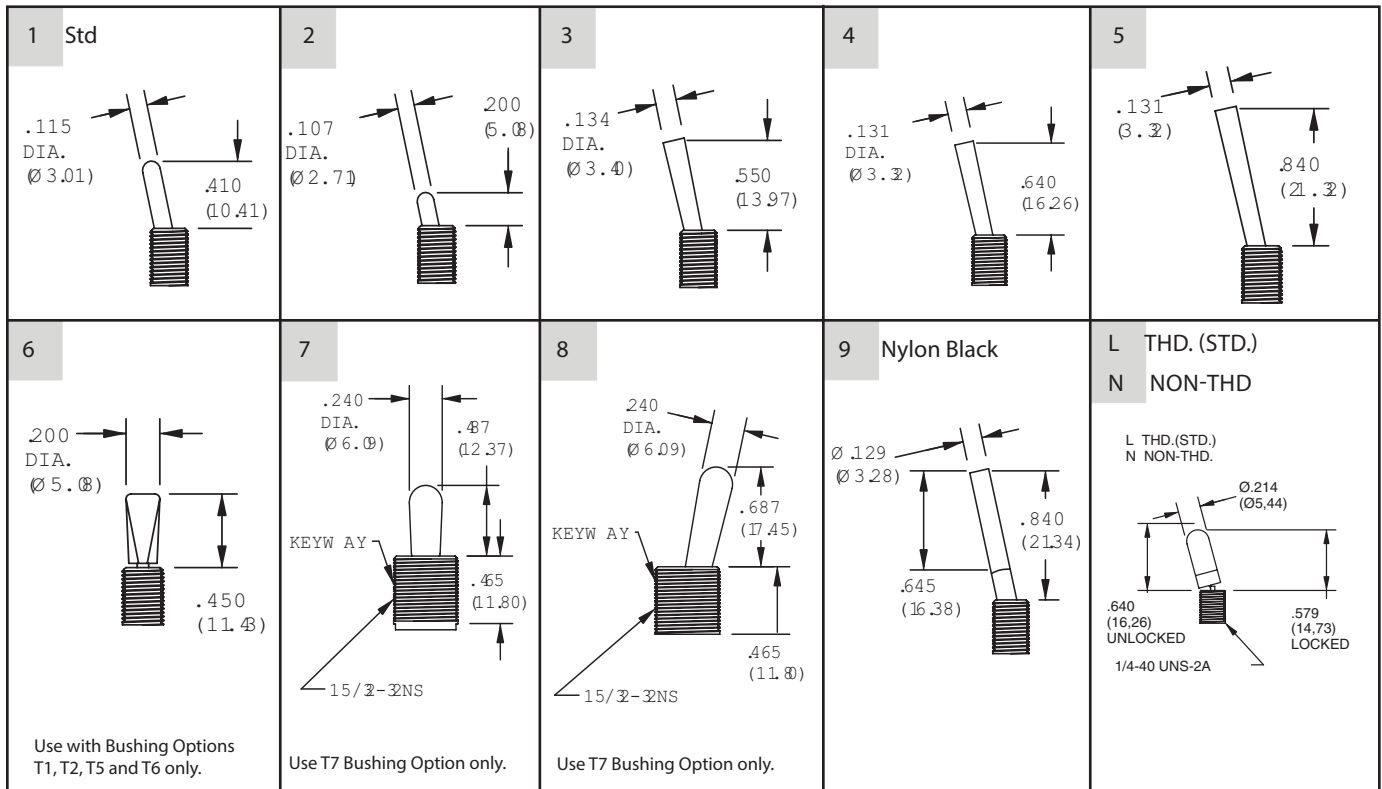

Actuators 1-5 shown with standard B1 bushing. Add .070 (1.78) for B3, subtract .020 (0.51) for B6 bushing.

BUSHING OPTIONS in inches (and millimeters)

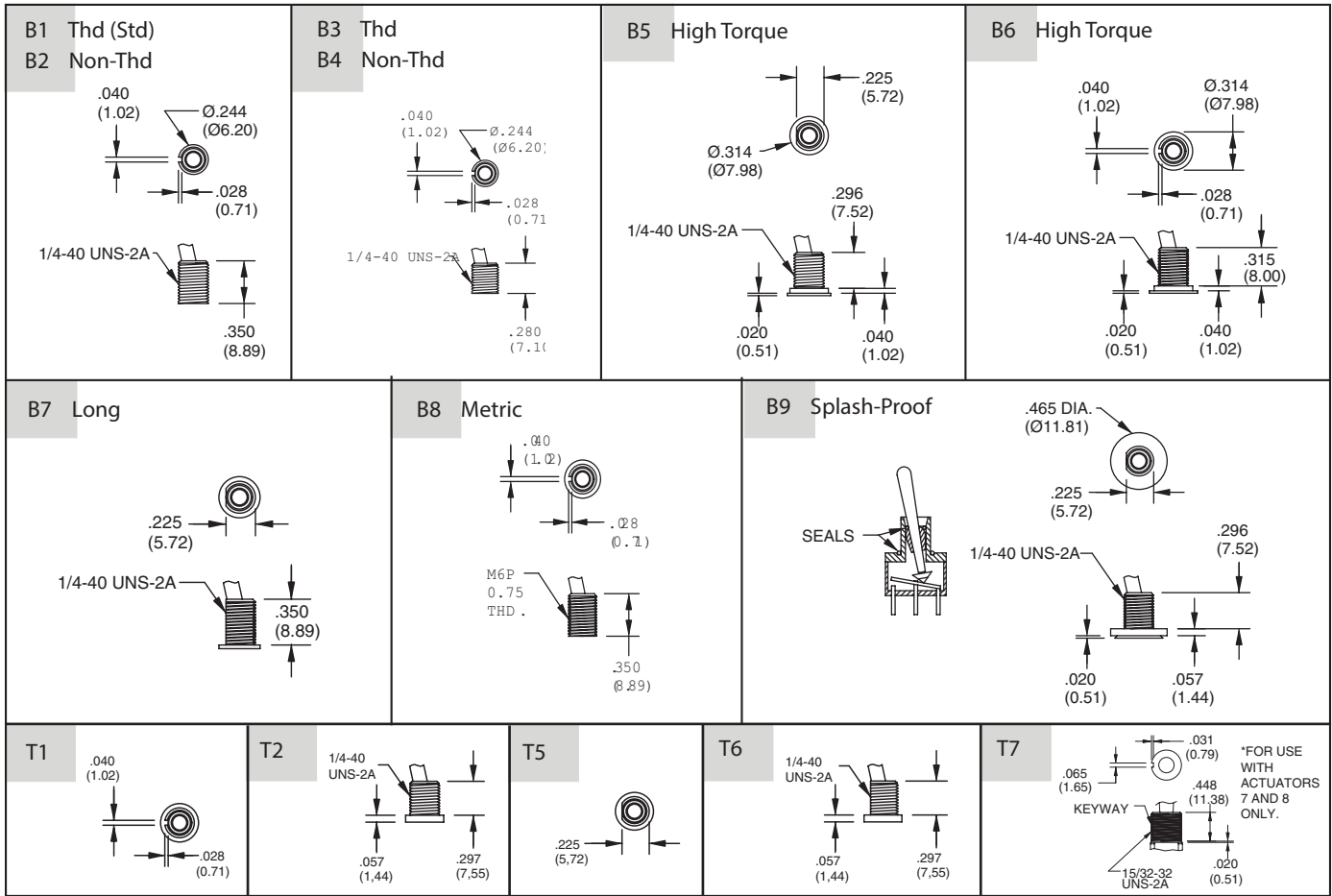

PANEL MOUNTING in inches (and millimeters)

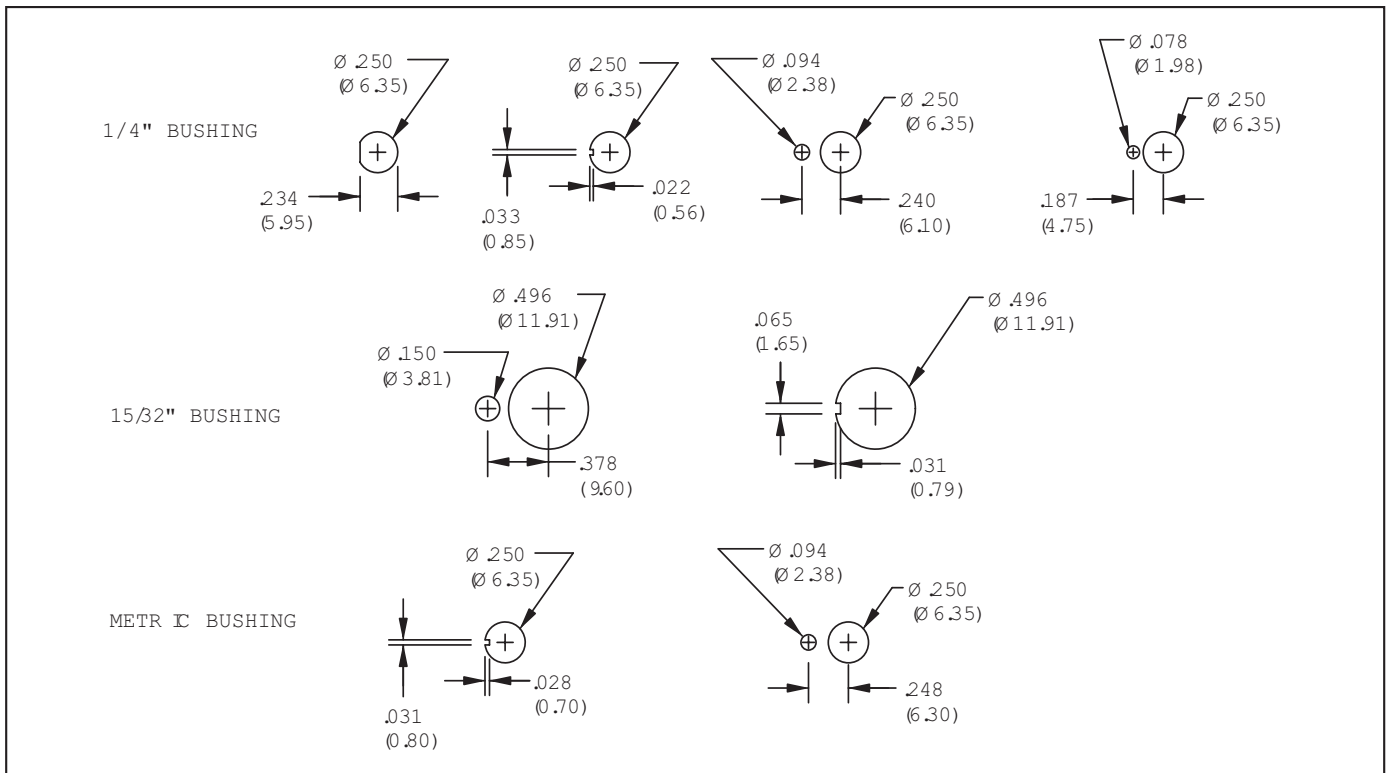

TERMINATION OPTIONS in inches (and millimeters)

<p>M1 Solder Lug (Std)</p>	<p>M2 P.C. Mount</p>	<p>M3 P.C. Mount, Quick Connect W</p>	<p>WIRE WRAP</p> <table border="1"> <thead> <tr> <th>OPTION CODE</th> <th>DIM."A"</th> </tr> </thead> <tbody> <tr> <td>W1</td> <td>.750(19.05)</td> </tr> <tr> <td>W2</td> <td>.964(24.48)</td> </tr> <tr> <td>W3</td> <td>.425(10.80)</td> </tr> <tr> <td>W4</td> <td>1.062(26.97)</td> </tr> </tbody> </table>	OPTION CODE	DIM."A"	W1	.750(19.05)	W2	.964(24.48)	W3	.425(10.80)	W4	1.062(26.97)
OPTION CODE	DIM."A"												
W1	.750(19.05)												
W2	.964(24.48)												
W3	.425(10.80)												
W4	1.062(26.97)												
<p>M6 Right Angle P.C. Mount, Horizontal Actuation</p>													
<p>M7 Right Angle P.C. Mount, Vertical Actuation</p>													

Toggle Switches

TERMINATION OPTIONS in inches (and millimeters)

M7 Right Angle P.C. Mount, Vertical Actuation

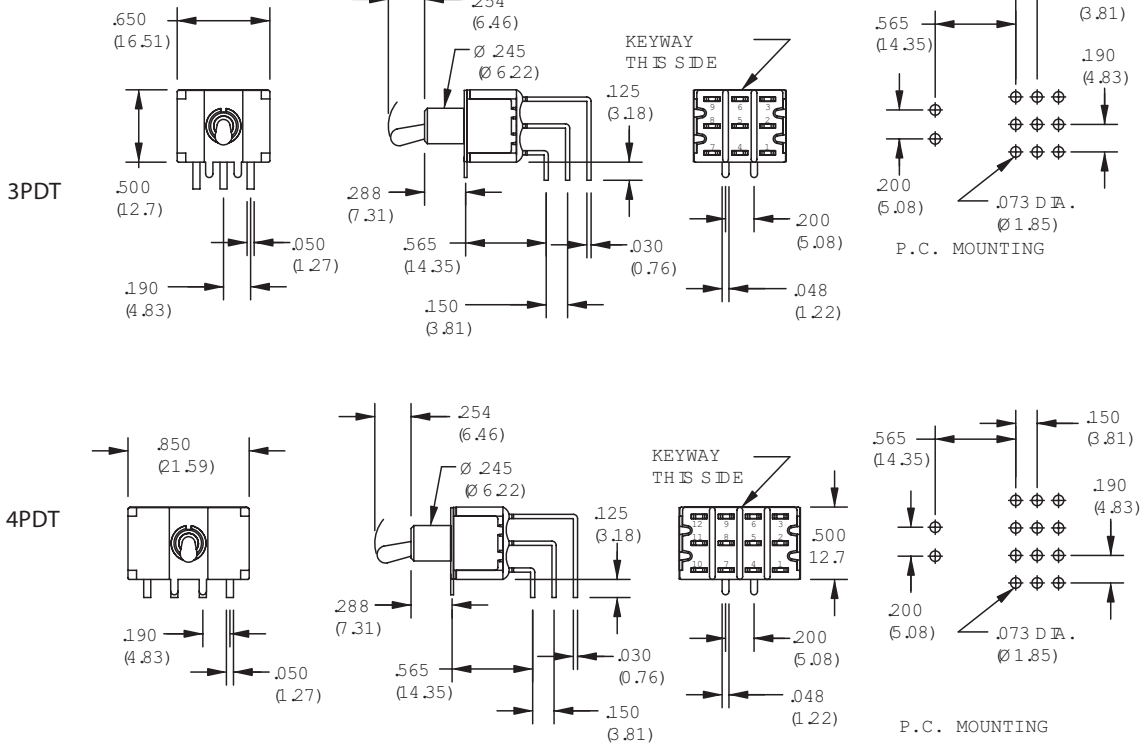

V2-V3 Vertical Bracket P.C. Mount

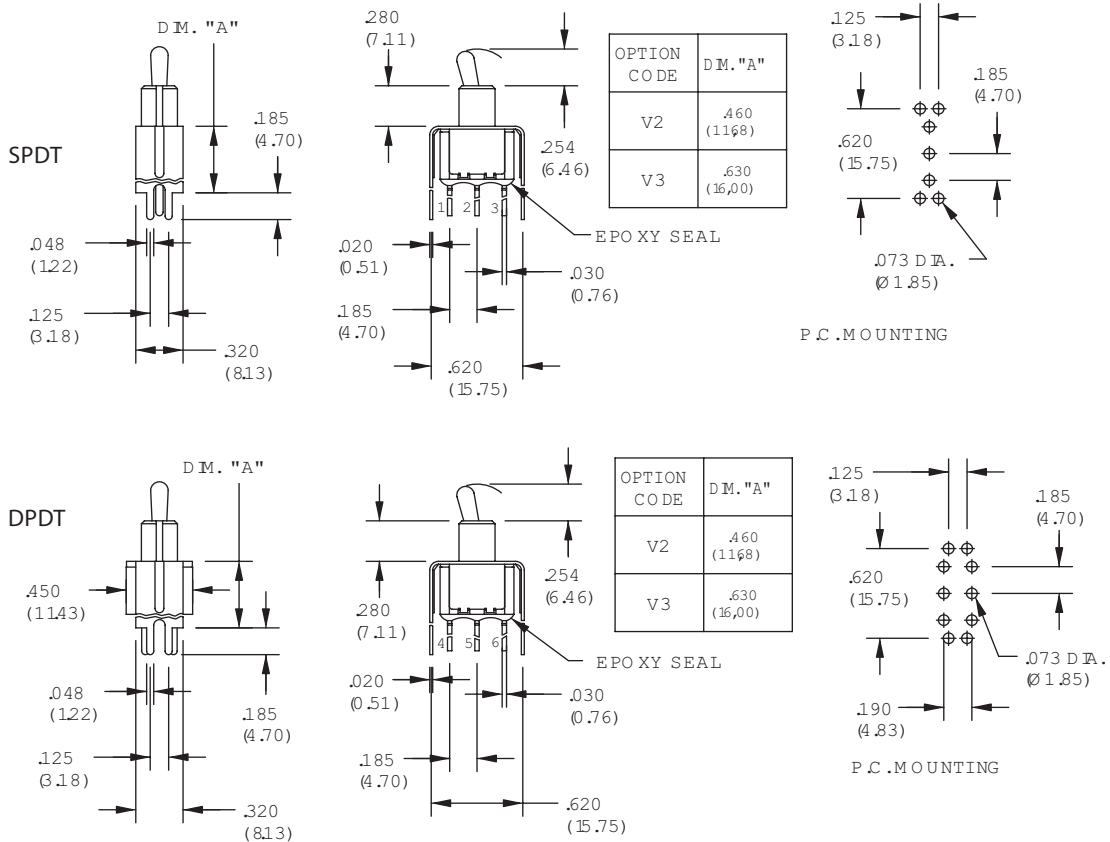

SPECIFICATIONS

RATINGS

Contact Rating: Q option - 5A with resistive load @ 125VAC or 28 VDC; 2A with resistive load @ 250 VAC. R option-0.4 VA max @ 20 Vmax (AC or DC)
 Electrical Life: 40,000 make-and-break cycles at full load

Contact Resistance: 10 milliohms max. initial @ 2-4 VDC, 100 mA for both gold & silver contacts
 Insulation Resistance: 1,000 megaohms minimum
 Dielectric Strength: 1,000 V RMS @ sea level
 Operating Temperature: -30°C to 85°C

UL Recognition: File number is E35289

MATERIALS

Case: Diallyl phthalate (DAP) (UL94V-0)
 Toggle Handle: Brass, chrome-plated
 Bushing: Brass, nickel-plated
 Housing: Stainless steel

ORDERING INFORMATION

34ASP12B4M2RT

Series 34A Miniature Toggle Switch
 Model: SPDT: SP1, SP2, SP3, SP4, SP5,
 DPDT: DP1, DP2, DP3, DP4, DP5
 3PDT: 3P1, 3P2, 3P3, 3P4, 3P5
 4PDT: 4P1, 4P2, 4P3, 4P4, 4P5
 (See Model options)
 Actuator Options: 1, 2, 3, 4, 5, 6, 7, 8, 9, L, N
 (See Actuator options.)
 Bushing Options: B1, B2, B3, B4, B5, B6, B7, B8, B9, T1, T2, T5, T6
 (See Bushing options.)

RoHS Compliant

Contact: R: Copper alloy, gold plate over nickel plate
 Q: Copper alloy, silver plated
 G: Copper alloy, gold plate over silver plate

Termination Options: M1, M2, M3, M6, M7, V2, V3, W1, W2, W3, W4
 (See Termination options.)

Available from your local Grayhill Component Distributor.
 For prices and discounts, contact a local Sales Office, an authorized local Distributor or Grayhill.

Toggle Switches

HARDWARE in inches (and millimeters)

NUTS

Series 34A (Std)	Dress Nut	For Actuator Options 7, 8 (Std)	Knurled Nut (Sealed)
 .180 DIA (ø4.56) .312 (7.92) 1/4-40UNS .062 (1.57) HDW2	 .352 (8.94) .372 DIA (ø9.45) 1/4-40UNS .118 (3.00) HDW3	 .562 (14.27) 15/32-32NS .078 (1.98) HDW4	 .638 DIA (ø16.21) 15/32-32NS .174 (4.42) HDW5

LOCKING RINGS	LOCK WASHERS								
<table border="1"> <tr> <th>Series 34A (Std)</th> <th>For Actuator Options 7, 8</th> </tr> <tr> <td> .476 DIA (ø12.1) .252 DIA (ø6.40) .031 (0.78) .109 DIA (ø2.76) .063 (1.60) HDW15 </td> <td> .476 DIA (ø12.1) .031 (0.78) .718 DIA (ø18.24) .034 (0.84) .478 DIA (ø12.14) .124 (3.15) .098 (2.48) HDW17 </td> </tr> </table>	Series 34A (Std)	For Actuator Options 7, 8	 .476 DIA (ø12.1) .252 DIA (ø6.40) .031 (0.78) .109 DIA (ø2.76) .063 (1.60) HDW15	 .476 DIA (ø12.1) .031 (0.78) .718 DIA (ø18.24) .034 (0.84) .478 DIA (ø12.14) .124 (3.15) .098 (2.48) HDW17	<table border="1"> <tr> <th>Series 34A (Std)</th> <th>For Actuator Options 7, 8</th> </tr> <tr> <td> .42B DIA (ø10.86) .251 DIA (ø6.38) THK (0.52) .02 HDW11 </td> <td> .620 DIA (ø15.74) .473 DIA (ø12.02) (0.52) .02 THK HDW12 </td> </tr> </table>	Series 34A (Std)	For Actuator Options 7, 8	 .42B DIA (ø10.86) .251 DIA (ø6.38) THK (0.52) .02 HDW11	 .620 DIA (ø15.74) .473 DIA (ø12.02) (0.52) .02 THK HDW12
Series 34A (Std)	For Actuator Options 7, 8								
 .476 DIA (ø12.1) .252 DIA (ø6.40) .031 (0.78) .109 DIA (ø2.76) .063 (1.60) HDW15	 .476 DIA (ø12.1) .031 (0.78) .718 DIA (ø18.24) .034 (0.84) .478 DIA (ø12.14) .124 (3.15) .098 (2.48) HDW17								
Series 34A (Std)	For Actuator Options 7, 8								
 .42B DIA (ø10.86) .251 DIA (ø6.38) THK (0.52) .02 HDW11	 .620 DIA (ø15.74) .473 DIA (ø12.02) (0.52) .02 THK HDW12								