

20KPA Series

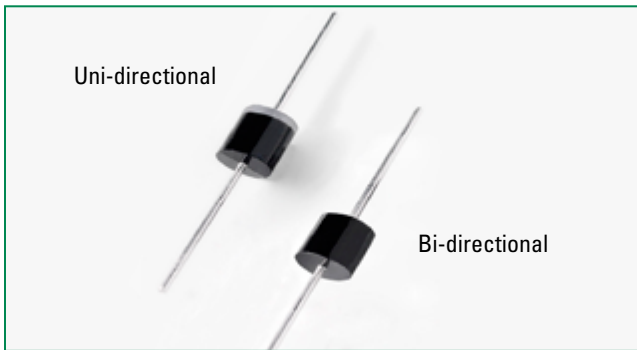

Agency Approvals

AGENCY	AGENCY FILE NUMBER
	E230531

Maximum Ratings and Thermal Characteristics (T_A=25°C unless otherwise noted)

Parameter	Symbol	Value	Unit
Peak Pulse Power Dissipation by 10/1000µs Test Waveform (Fig.2) (Note 1)	P _{PPM}	20000	W
Steady State Power Dissipation on Infinite Heat Sink at T _L =75°C	P _D	8.0	W
Peak Forward Surge Current, 8.3ms Single Half Sine Wave Unidirectional Only (Note 2)	I _{FSM}	400	A
Operating Junction and Storage Temperature Range	T _J , T _{STG}	-55 to 175	°C
Typical Thermal Resistance Junction to Lead	R _{θJL}	8.0	°C/W
Typical Thermal Resistance Junction to Ambient	R _{θJA}	40	°C/W

Notes:

1. Non-repetitive current pulse, per Fig. 4 and derated above T_J (initial) =25°C per Fig. 3.
2. Measured on 8.3ms single half sine wave or equivalent square wave, duty cycle=4 per minute maximum.

Functional Diagram

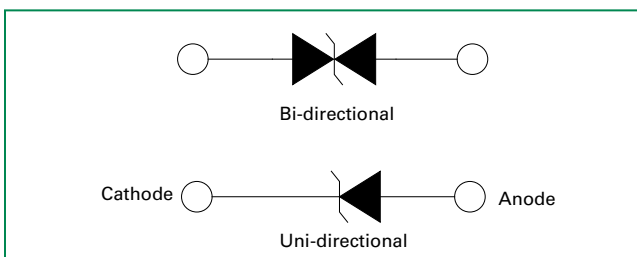

Descriptions

The 20KPA Series is designed specifically to protect sensitive electronic equipment from voltage transients induced by lightning and other transient voltage events.

Features

- 20000W peak pulse capability at 10/1000µs waveform, repetition rate (duty cycles):0.01%
- Glass passivated chip junction in P600 package
- Fast response time: typically less than 1.0ps from 0 Volts to BV min
- Excellent clamping capability
- Typical failure mode is short from over-specified voltage or current
- Whisker test is conducted based on JEDEC JESD201A per its table 4a and 4c
- IEC-61000-4-2 ESD 30kV(Air), 30kV (Contact)
- ESD protection of data lines in accordance with IEC 61000-4-2
- EFT protection of data lines in accordance with IEC 61000-4-4
- Low incremental surge resistance
- Typical I_R less than 2µA when V_{BR} min>49V
- High temperature to reflow soldering guaranteed: 260°C/40sec / 0.375", (9.5mm) lead length, 5 lbs., (2.3kg) tension
- V_{BR} @ T_J = V_{BR} @ 25°C x (1 + α T x (T_J - 25)) (α T: Temperature Coefficient, typical value is 0.1%)
- Plastic package is flammability rated V-0 per Underwriters Laboratories
- Matte tin lead-free plated
- Halogen free and RoHS compliant
- Pb-free E3 means 2nd level interconnect is Pb-free and the terminal finish material is tin(Sn) (IPC/JEDEC J-STD-609A.01)

Applications

TVS devices are ideal for the protection of I/O interfaces, V_{CC} bus and other vulnerable circuits used in telecom, computer, industrial and consumer electronic applications.

Additional Information



Datasheet



Resources



Samples

Transient Voltage Suppression Diodes

Axial Leaded – 20000W > 20KPA series

Electrical Characteristics ($T_A=25^\circ\text{C}$ unless otherwise noted)

Part Number (Uni)	Part Number (Bi)	Reverse Stand off Voltage V_R (Volts)	Breakdown Voltage V_{BR} (Volts) @ I_T		Test Current I_T (mA)	Maximum Peak Pulse Current I_{pp} (A)	Maximum Reverse Leakage $I_R @ V_R$ (μA)	Maximum Clamping Voltage $V_C @ I_{pp}$ (V)	Agency Approval 
			MIN	MAX					
20KPA20A	20KPA20CA	20	22.34	24.57	50	548.9	5000	36.8	X
20KPA24A	20KPA24CA	24	26.81	29.49	50	490.3	5000	41.2	X
20KPA26A	20KPA26CA	26	29.04	31.94	50	451.9	2000	44.7	X
20KPA28A	20KPA28CA	28	31.28	34.41	50	420.8	1000	48.0	X
20KPA30A	20KPA30CA	30	33.51	36.86	5	392.2	250	51.5	X
20KPA32A	20KPA32CA	32	35.74	39.31	5	372.0	150	54.3	X
20KPA34A	20KPA34CA	34	38.00	41.80	5	351.3	50	57.5	X
20KPA36A	20KPA36CA	36	40.20	44.22	5	328.5	20	61.5	X
20KPA40A	20KPA40CA	40	44.70	49.17	5	297.9	15	67.8	X
20KPA44A	20KPA44CA	44	49.10	54.01	5	277.9	2	72.7	X
20KPA48A	20KPA48CA	48	53.60	58.96	5	254.4	2	79.4	X
20KPA52A	20KPA52CA	52	58.10	63.91	5	235.4	2	85.8	X
20KPA56A	20KPA56CA	56	62.60	68.86	5	218.1	2	92.6	X
20KPA60A	20KPA60CA	60	67.00	73.70	5	207.0	2	97.6	X
20KPA64A	20KPA64CA	64	71.50	78.65	5	194.2	2	104.0	X
20KPA68A	20KPA68CA	68	76.00	83.60	5	183.6	2	110.0	X
20KPA72A	20KPA72CA	72	80.40	88.44	5	174.1	2	116.0	X
20KPA80A	20KPA80CA	80	89.40	98.34	5	155.4	2	130.0	X
20KPA88A	20KPA88CA	88	98.30	108.13	5	142.3	2	142.0	X
20KPA96A	20KPA96CA	96	107.20	117.92	5	130.3	2	155.0	X
20KPA104A	20KPA104CA	104	116.20	127.82	5	120.2	2	168.0	X
20KPA112A	20KPA112CA	112	125.10	137.61	5	111.0	2	182.0	X
20KPA120A	20KPA120CA	120	134.00	147.40	5	104.1	2	194.0	X
20KPA132A	20KPA132CA	132	147.40	162.14	5	94.8	2	213.0	X
20KPA144A	20KPA144CA	144	160.80	176.88	5	87.1	2	232.0	X
20KPA160A	20KPA160CA	160	178.70	196.57	5	78.3	2	258.0	X
20KPA172A	20KPA172CA	172	192.10	211.31	5	72.9	2	277.0	X
20KPA180A	20KPA180CA	180	201.10	221.21	5	69.4	2	291.0	X
20KPA192A	20KPA192CA	192	214.50	235.95	5	65.4	2	309.0	X
20KPA204A	20KPA204CA	204	227.90	250.69	5	61.4	2	329.0	X
20KPA216A	20KPA216CA	216	241.30	265.43	5	58.0	2	348.0	X
20KPA232A	20KPA232CA	232	259.10	285.01	5	54.0	2	374.0	X
20KPA240A	20KPA240CA	240	268.10	294.91	5	52.2	2	387.0	X
20KPA256A	20KPA256CA	256	286.00	314.60	5	49.0	2	412.0	X
20KPA280A	20KPA280CA	280	312.80	344.08	5	44.8	2	451.0	X
20KPA300A	20KPA300CA	300	335.10	368.61	5	41.8	2	483.0	X

For bidirectional type having V_{RWM} of 40 volts and less, the I_R limit is double.

For parts without A, the V_{BR} is $\pm 10\%$ and V_C is 5% higher than with A parts.

I-V Curve Characteristics

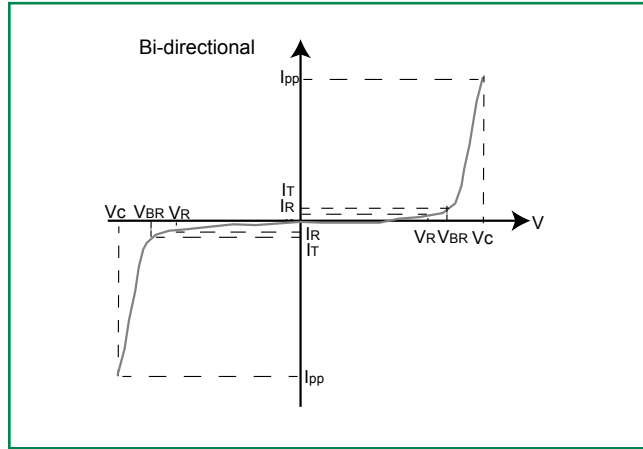
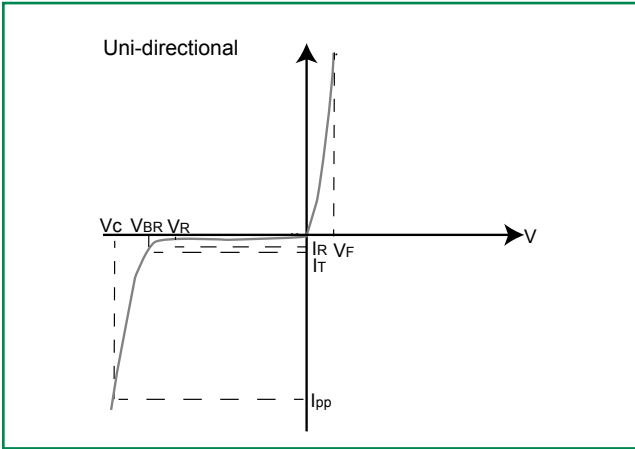

- P_{PPM} Peak Pulse Power Dissipation** – Max power dissipation
- V_R Stand-off Voltage** – Maximum voltage that can be applied to the TVS without operation
- V_{BR} Breakdown Voltage** – Maximum voltage that flows through the TVS at a specified test current (I_T)
- V_C Clamping Voltage** – Peak voltage measured across the TVS at a specified I_{ppm} (peak impulse current)
- I_R Reverse Leakage Current** – Current measured at V_R
- V_F Forward Voltage Drop for Uni-directional**

Ratings and Characteristic Curves ($T_A=25^\circ\text{C}$ unless otherwise noted)

Figure 1 - TVS Transients Clamping Waveform

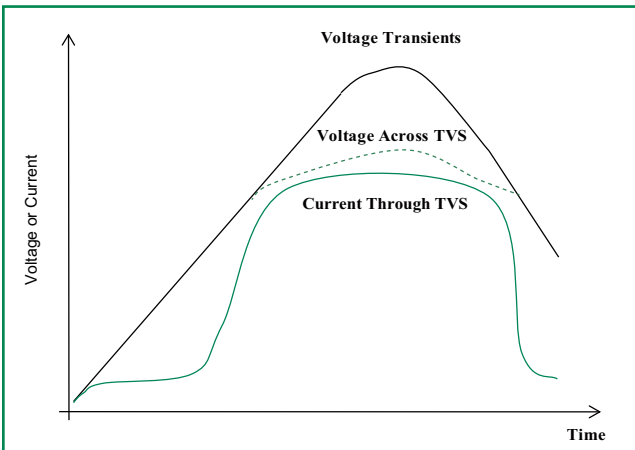
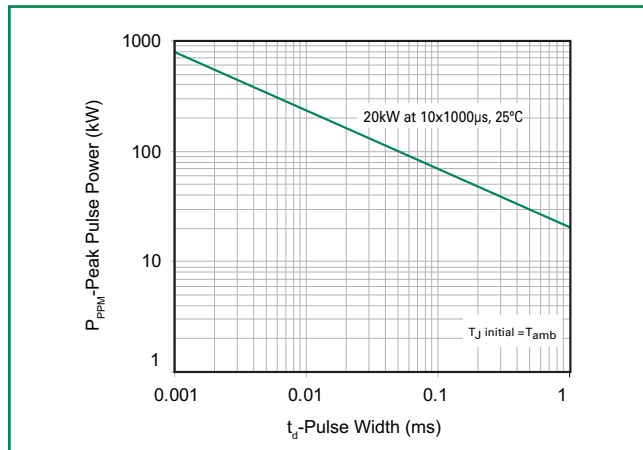

Figure 2 - Peak Pulse Power Rating Curve



continues on next page.

Ratings and Characteristic Curves ($T_A=25^\circ\text{C}$ unless otherwise noted) (Continued)

Figure 3 - Peak Pulse Power Derating Curve

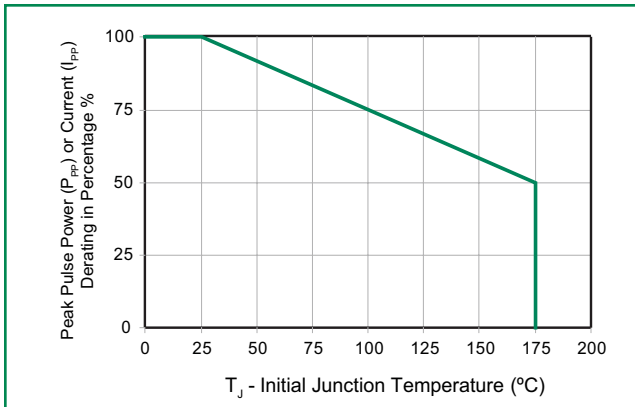

Figure 4 - Pulse Waveform

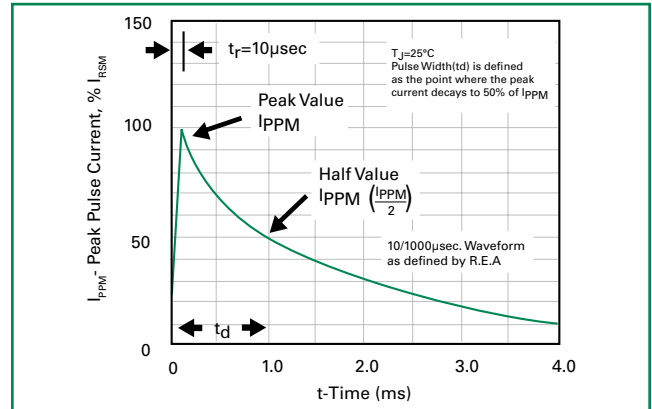

Figure 5 - Typical Junction Capacitance

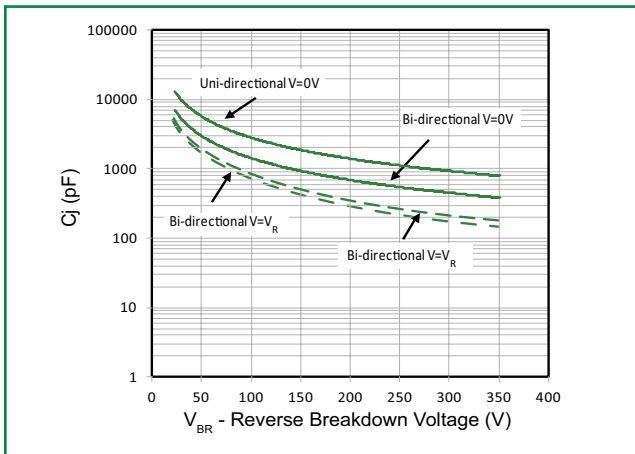

Figure 6 - Typical Transient Thermal Impedance

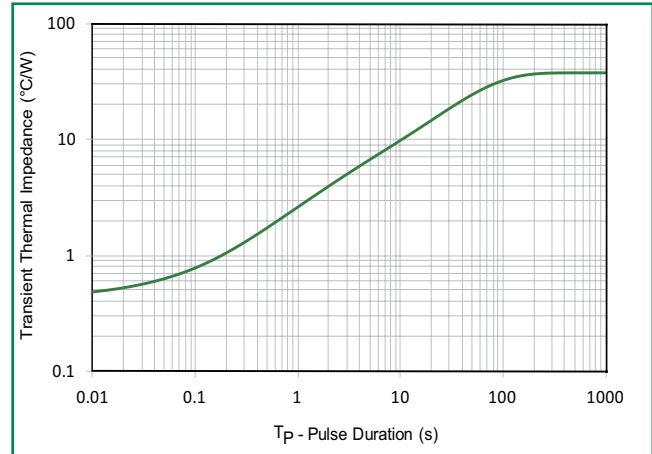

Figure 7 - Maximum Non-Repetitive Peak Forward Surge Current Uni-Directional Only

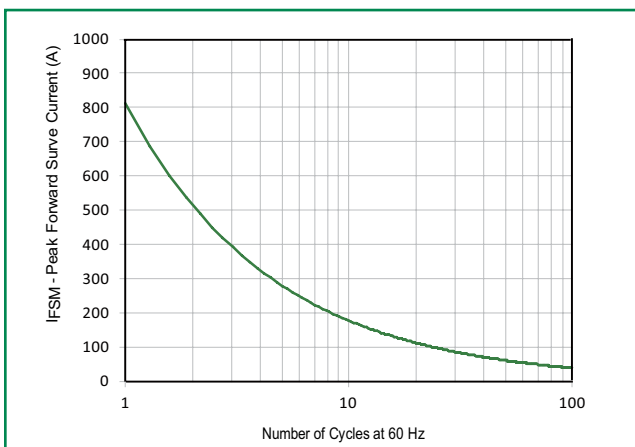
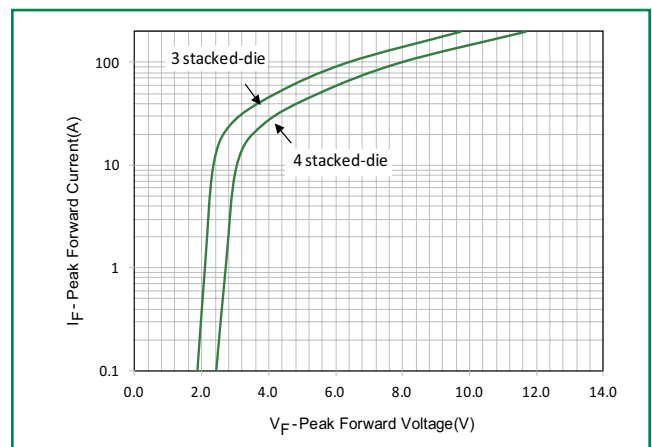
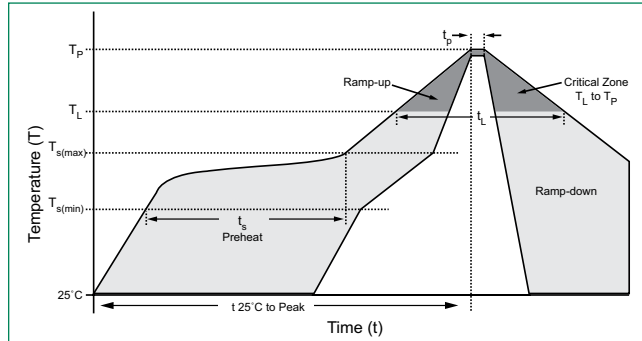

Figure 8 - Peak Forward Voltage Drop vs Peak Forward Current (Typical Values)



Soldering Parameter

Reflow Condition		Lead-free assembly
Pre Heat	- Temperature Min ($T_{s(min)}$)	150°C
	- Temperature Max ($T_{s(max)}$)	200°C
	- Time (min to max) (t_s)	60 – 180 secs
Average ramp up rate (Liquidus Temp (T_A) to peak)		3°C/second max
$T_{s(max)}$ to T_A - Ramp-up Rate		3°C/second max
Reflow	- Temperature (T_A) (Liquidus)	217°C
	- Time (min to max) (t_s)	60 – 150 seconds
Peak Temperature (T_p)		260 ^{+0/-5} °C
Time within 5°C of actual peak Temperature (t_p)		20 – 40 seconds
Ramp-down Rate		6°C/second max
Time 25°C to peak Temperature (T_p)		8 minutes Max.
Do not exceed		260°C



Flow/Wave Soldering (Solder Dipping)

Peak Temperature :	265°C
Dipping Time :	10 seconds
Soldering :	1 time

Physical Specifications

Weight	0.07oz., 2.5g
Case	P600 molded plastic body over passivated junction.
Polarity	Color band denotes the cathode except Bipolar.
Terminal	Matte Tin axial leads, solderable per JESD22-B102.

Environmental Specifications

High Temp. Storage	JESD22-A103
HTRB	JESD22-A108
Temperature Cycling	JESD22-A104
H3TRB	JESD22-A101
RSH	JESD22-B106

Dimensions

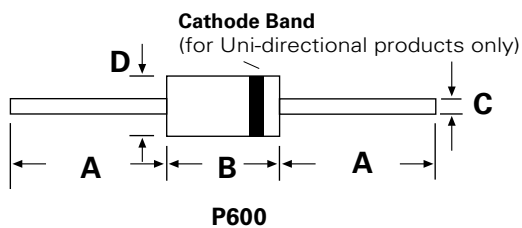

Dimensions	Inches		Millimeters	
	Min	Max	Min	Max
A	1.000	-	25.40	-
B	0.340	0.360	8.60	9.10
C	0.048	0.052	1.22	1.32
D	0.340	0.360	8.60	9.10

Part Numbering System

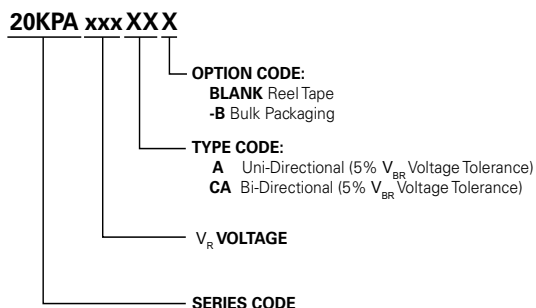

Part Marking System

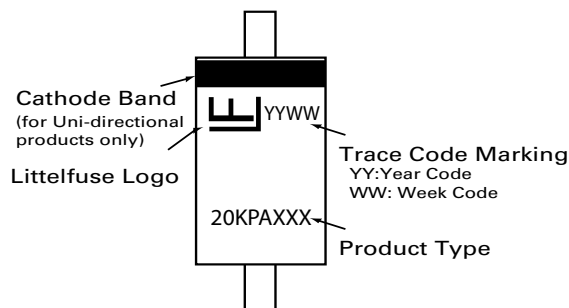

Packing Options

Part Number	Component Package	Quantity	Packaging Option	Packaging Specification
20KPAxxxXX	P600	800	Tape & Reel	EIA STD RS-296
20KPAxxxXX-B	P600	100	Bulk	Littelfuse Spec.

Tape and Reel Specification

