

NPR NPS 2-T220 NHR NHS 2-T220 T221

Power Resistors

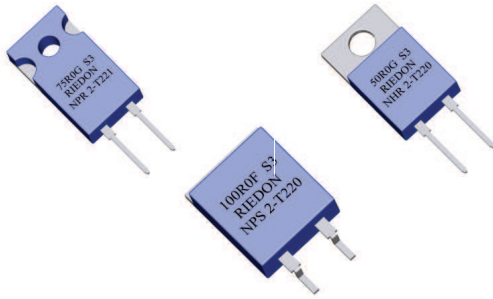

- Resistances from 0.02Ohm to 100kOhms
- Power Rating to 50Watt
- Resistance Tolerances to $\pm 1\%$
- TCR to $\pm 50\text{ppm}/^\circ\text{C}$
- Load Stability to 0.5%
- TO-220 Housing
- Convenient SMD D2Pak Available



SPECIFICATIONS

Type	NPR / NPS	NHR / NHS																
Resistance Range	0.02 Ohms to 100kOhms	0.02 Ohms to 15kOhms																
Power rating free air 70°C with heatsink	1.5 W 30 W	1.5 W 50 W																
Thermal Resistance Rthj-c	3.5 K/W	2.1 K/W																
Tolerances from 0.02 Ohms from 1.0 Ohms	2% / 5% 1% / 2% / 5%																	
Stability	0.5%																	
Temperature Coefficient 0.02 to 0.049 Ohms 0.05 to 0.099 Ohms 0.1 Ohms to 100 kOhms	$\pm 600\text{ ppm}/^\circ\text{C}$ $\pm 300\text{ ppm}/^\circ\text{C}$ $\pm 100\text{ ppm}/^\circ\text{C}$ upon request $\pm 50\text{ ppm}/^\circ\text{C}$																	
Voltage Proof	2.0 kVDC	1.5 kVDC																
Max. Voltage depending on resistance value	<table border="1"> <caption>Max. Working Voltage vs Resistance</caption> <thead> <tr> <th>Resistance (Ohm)</th> <th>Max. Working Voltage (VDC)</th> </tr> </thead> <tbody> <tr><td>2</td><td>10</td></tr> <tr><td>10</td><td>20</td></tr> <tr><td>100</td><td>100</td></tr> <tr><td>1k</td><td>200</td></tr> <tr><td>5k</td><td>500</td></tr> <tr><td>10k</td><td>1000</td></tr> <tr><td>100k</td><td>1000</td></tr> </tbody> </table>		Resistance (Ohm)	Max. Working Voltage (VDC)	2	10	10	20	100	100	1k	200	5k	500	10k	1000	100k	1000
Resistance (Ohm)	Max. Working Voltage (VDC)																	
2	10																	
10	20																	
100	100																	
1k	200																	
5k	500																	
10k	1000																	
100k	1000																	
Operating Temperature Range	-40 to 155°C																	
Resistor Material	Thick Film																	
Substrate	Al ₂ O ₃																	
Housing	Epoxy or PPS																	
Connector Material	Cu tinned																	
Terminals	2																	
Max. Torque	T220: 1 Nm T221: 0.8 Nm																	

SPECIFICATIONS (continued)

Temperature Coefficient

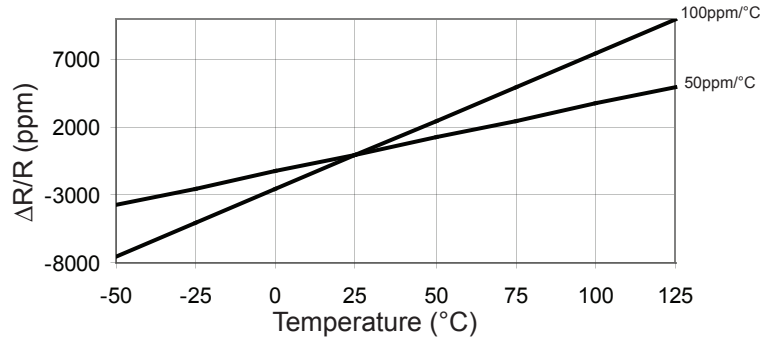

Derating

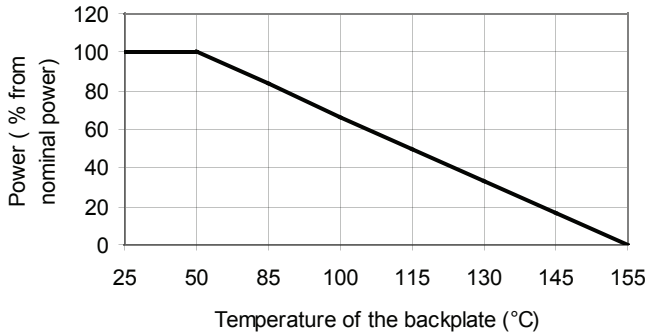

Power Rating Notes -

The NPR / NHR Series Resistors must be attached to a suitable heatsink. The maximum internal resistor temperature is 155°C. To specify an appropriate heatsink use the following formula :

$$R_{\theta H} = \frac{T_{MAX} - (P \times R_{\theta R}) - T_A}{P}$$

Where: $R_{\theta H}$ = Thermal Resistance of Heatsink (K/W)
 $R_{\theta R}$ = Thermal Resistance of Resistor (K/W)
 T_{MAX} = Maximum Temperature of Resistor
 T_A = Ambient Temperature of Heatsink (°C)
 P = Power Through Resistor (W)

Dimensions

NPS / NHS 2-T220

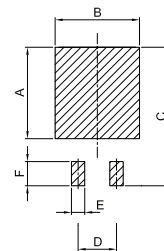
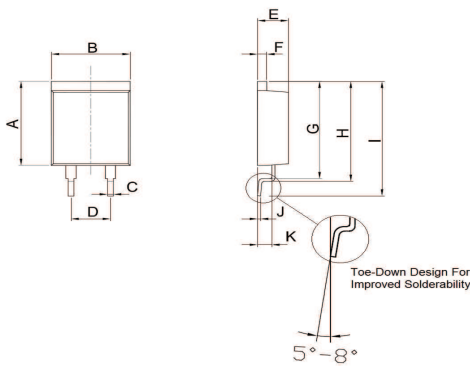

Dimension	mm	tol. (±mm)	inches	tol. (±inches)
A	12.70	0.2	0.50	0.008
B	10.16	0.2	0.40	0.008
C	0.76	0.1	0.03	0.004
D	5.08	0.1	0.20	0.004
E	4.00	0.1	0.16	0.004
F	1.20	0.1	0.05	0.004
G	14.60	0.2	0.57	0.008
H	15.00	0.2	0.59	0.008
I	17.33	0.2	0.68	0.008
J	0.40	0.1	0.02	0.004
K	1.85	0.1	0.07	0.004

Dimension	mm	inches
A	12.10	0.476
B	11.16	0.439
C	18.33	0.722
D	5.08	0.200
E	1.76	0.069
F	3.20	0.126

SPECIFICATIONS (continued)

NPR / NHR 2-T220

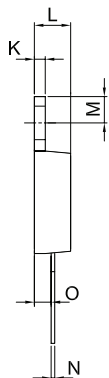
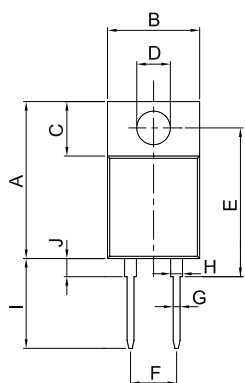

Dimension	mm	tol. (±mm)	inches	tol. (±inches)
A	17.30	0.2	0.68	0.008
B	10.16	0.2	0.40	0.008
C	6.00	0.1	0.24	0.004
D	Ø3.7	0.1	Ø0.146	0.004
E	16.40	0.2	0.65	0.008
F	5.08	0.1	0.20	0.004
G	0.76	0.1	0.03	0.004
H	1.30	0.1	0.05	0.004
I	13.80	0.2	0.54	0.008
J	2.00	0.1	0.08	0.004
K	1.20	0.1	0.05	0.004
L	4.00	0.1	0.16	0.004
M	2.90	0.1	0.11	0.004
N	0.40	0.1	0.02	0.004
O	1.85	0.1	0.07	0.004

NPR / NHR 2-T221

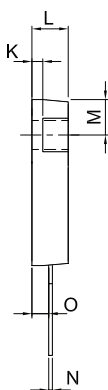
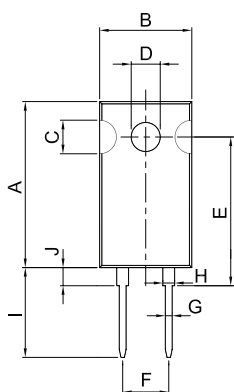

Dimension	mm	tol. (±mm)	inches	tol. (±inches)
A	18.30	0.2	0.72	0.008
B	10.16	0.2	0.40	0.008
C	3.70	0.1	0.15	0.004
D	Ø3.2	0.1	Ø0.126	0.004
E	16.40	0.2	0.65	0.008
F	5.08	0.1	0.20	0.004
G	0.76	0.1	0.03	0.004
H	1.30	0.1	0.05	0.004
I	13.80	0.2	0.54	0.008
J	2.00	0.1	0.08	0.004
K	1.20	0.1	0.05	0.004
L	4.00	0.1	0.16	0.004
M	3.90	0.1	0.15	0.004
N	0.40	0.1	0.02	0.004
O	1.85	0.1	0.07	0.004

Ordering Information

Part Description: Part Type - Resistance - Contact - Tolerance
 NHR 2-T221 C 1.1 kOhms 1%