

Coiltronics RL1218 Series

Unshielded radial leaded drum core inductors

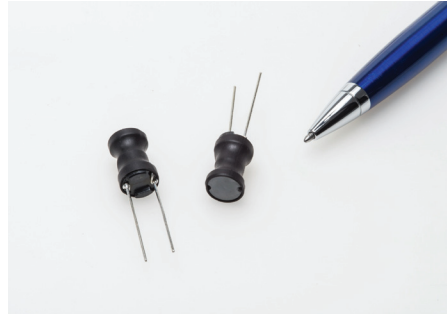

Product description

- Unshielded, leaded drum core
- Protective sleeving over winding
- Inductance range from 4.7 μ H to 12,000 μ H
- Current range from 0.20A to 15.0A
- 12.2 OD x 18.0mm through-hole package
- Ferrite core material
- Halogen free, lead free, RoHS compliant

Applications

- LED Drivers and lighting
- Utility meters
- Appliances and white goods
- Motor drives
- Power supplies
- General purpose filtering

Environmental data

- Storage temperature range (Component): -40°C to +125°C
- Operating temperature range: -40°C to +125°C (ambient + self-temperature rise)



Powering Business Worldwide



The Coiltronics brand of magnetics (formerly of the Bussmann Division of Cooper Industries) is now part of Eaton's Electrical Group, Electronics Division.

Coiltronics is now part of Eaton
Same great products plus even more.

Product specifications

Part Number ⁴	OCL ¹ (μH) $\pm 10\%$	I_{rms}^2 (amps)	I_{sat}^3 (amps)	DCR (Ω) @ 20°C max.	SRF (MHz) typ.
RL1218-4R7-R	4.7 $\pm 20\%$	5.65	15.0	0.017	34
RL1218-8R2-R	8.2 $\pm 20\%$	4.75	10.7	0.025	25
RL1218-100-R	10	4.61	10.2	0.026	21
RL1218-150-R	15	4.05	8.00	0.034	11
RL1218-220-R	22	3.64	6.60	0.042	8
RL1218-270-R	27	3.44	5.97	0.047	6
RL1218-330-R	33	3.27	5.45	0.052	5
RL1218-101-R	100	2.31	3.16	0.102	3
RL1218-151-R	150	1.89	2.56	0.159	3
RL1218-181-R	180	1.64	2.34	0.211	3
RL1218-221-R	220	1.53	2.10	0.241	2
RL1218-331-R	330	1.25	1.73	0.366	2
RL1218-561-R	560	0.968	1.33	0.606	1
RL1218-102-R	1000	0.677	0.992	1.23	1
RL1218-152-R	1500	0.597	0.809	1.59	0.81
RL1218-472-R	4700	0.322	0.457	5.46	0.40
RL1218-562-R	5600	0.305	0.418	6.11	0.40
RL1218-682-R	6800	0.263	0.379	8.20	0.36
RL1218-123-R	12,000	0.201	0.286	14.1	0.28

- Open Circuit Inductance (OCL) Test Parameters: 10kHz, 0.1V_{rms}, 0.0Adc, 25°C
- I_{rms} : DC current for an approximate temperature rise of 40°C without core loss. Derating is necessary for AC currents. PCB layout, trace thickness and width, air-flow, and proximity of other heat generating components will affect the temperature rise. It is recommended that the temperature of the part not exceed 125°C under worst case operating conditions verified in the end application.

- I_{sat} : Peak current for approximately 5% rolloff at +25°C
- Part Number Definition: RL1218-yyy-R
 - RL1218 = Product code and size
 - yyy= Inductance value in μH , R = decimal point, if no R is present then third character = number of zeros.
 - "-R" suffix = RoHS compliant

Dimensions - mm

Top view

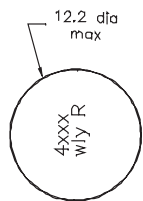

Side view

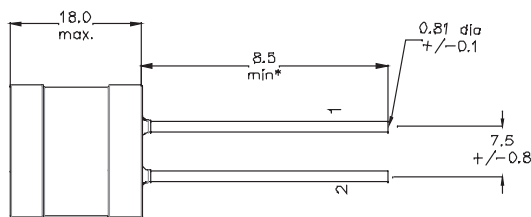

Recommended pad layout

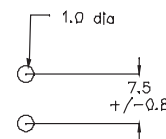

Schematic

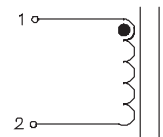

Part marking: 4xxx
wly R

4 = RL1218
xxx = inductance in μH , R = decimal point; if there is no "R" then third character = number of zeros
wly = date code, R = revision level

* Lead length is after the components are trimmed from the packaging tape roll.

Packaging information - mm

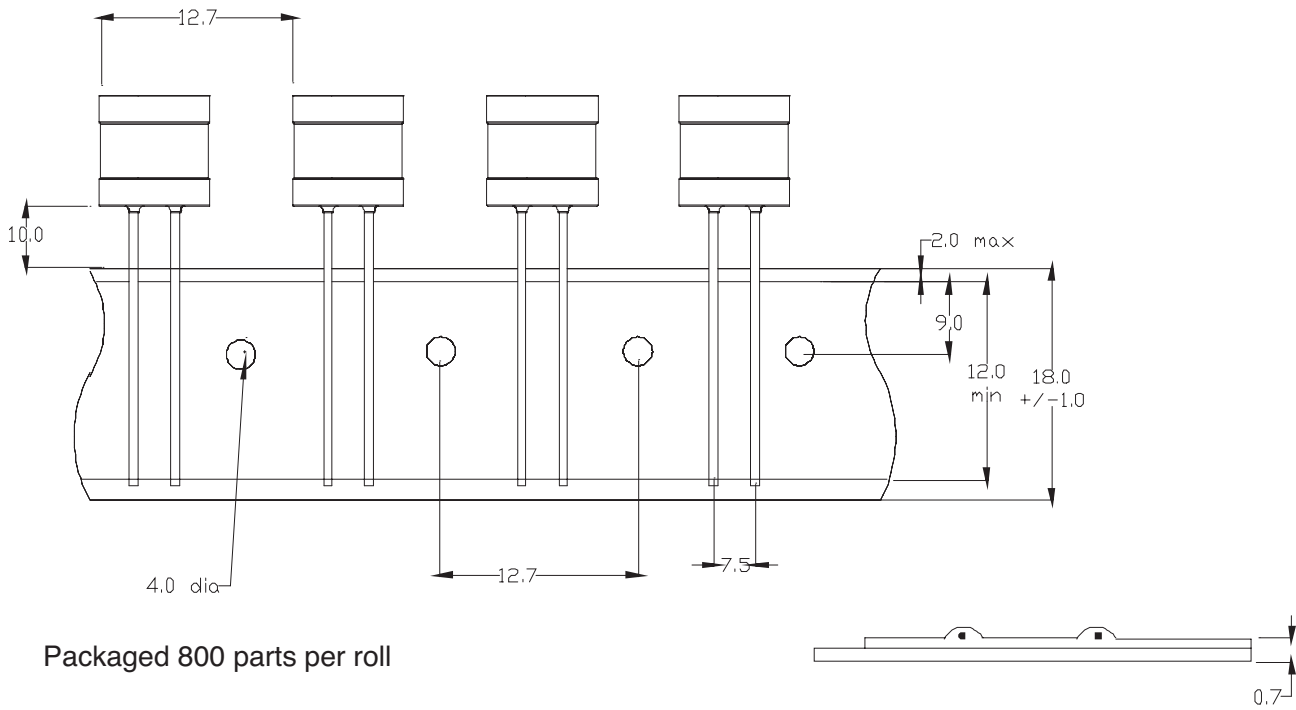

Inductance characteristics

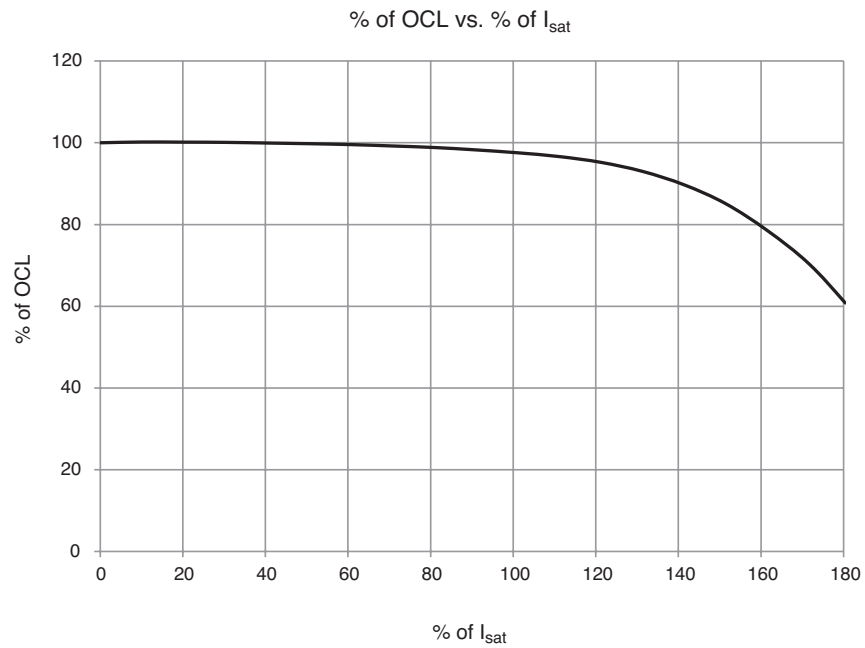

Wave solder profile

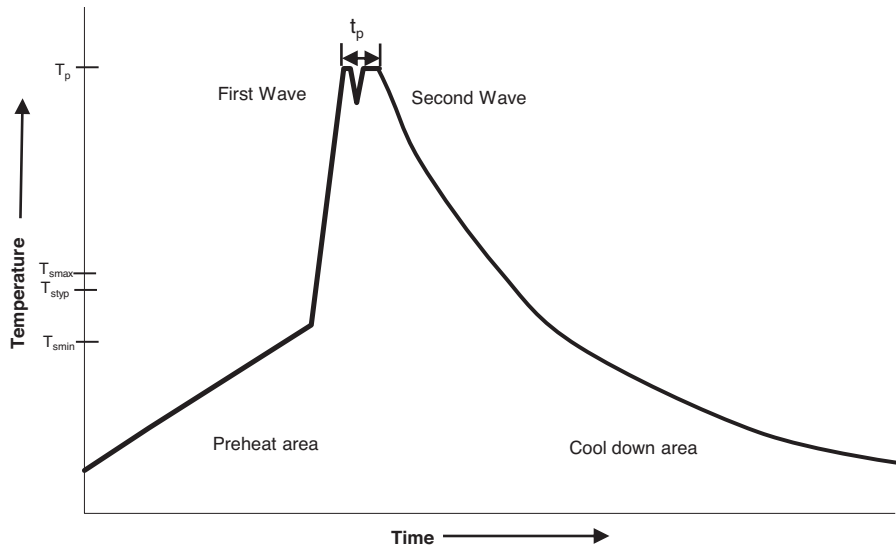

Reference EN 61760-1:2006

Profile Feature	Standard SnPb Solder	Lead (Pb) Free Solder
Preheat		
Temperature min. (T_{smin})	100°C	100°C
Temperature typ. (T_{styp})	120°C	120°C
Temperature max. (T_{smax})	130°C	130°C
Time (T_{smin} to T_{smax}) (t_s)	70 seconds	70 seconds
Δ preheat to max Temperature	150°C max.	150°C max.
Peak temperature (T_p)	235°C - 260°C	250°C - 260°C
Time at peak temperature (t_p)	10 seconds max 5 seconds max each wave	10 seconds max 5 seconds max each wave
Ramp-down rate	~ 2 K/s min ~3.5 K/s typ ~5 K/s max	~ 2 K/s min ~3.5 K/s typ ~5 K/s max
Time 25°C to 25°C	4 minutes	4 minutes

Manual solder

350°C, 4-5 seconds. (by soldering iron), generally manual, hand soldering is not recommended.

North America

Eaton's Electrical Group
Electronics Division
1225 Broken Sound Parkway NW
Suite F
Boca Raton, FL 33487-3533
Tel: 1-561-998-4100
Fax: 1-561-241-6640
Toll Free: 1-888-414-2645

Eaton's Electrical Group
Electronics Division
P.O. Box 14460
St. Louis, MO 63178-4460
Tel: 1-636-394-2877
Fax: 1-636-527-1607

Europe

Eaton's Electrical Group
Electronics Division
Burton-on-the-Wolds
Leicestershire, LE 12 5th UK
Phone: +44 (0) 1509 882 600
Fax: +44 (0) 1509 882 786

Eaton's Electrical Group
Electronics Division
Avda Santa Eulalia, 290
Terrassa, Barcelona 08223 Spain
Phone: +34-93-736-2813
Fax: +34-93-783-5055

Asia Pacific

Eaton's Electrical Group
Electronics Division
No.2, #06-01
Serangoon North Avenue 5
Singapore 554911
Tel: +65 6645 9888
Fax: +65 6728 3155

The only controlled copy of this Data Sheet is the electronic read-only version located on the Bussmann Network Drive. All other copies of this document are by definition uncontrolled. This bulletin is intended to clearly present comprehensive product data and provide technical information that will help the end user with design applications. Bussmann reserves the right, without notice, to change design or construction of any products and to discontinue or limit distribution of any products. Bussmann also reserves the right to change or update, without notice, any technical information contained in this bulletin. Once a product has been selected, it should be tested by the user in all possible applications.

Life Support Policy: Bussmann does not authorize the use of any of its products for use in life support devices or systems without the express written approval of an officer of the Company. Life support systems are devices which support or sustain life, and whose failure to perform, when properly used in accordance with instructions for use provided in the labeling, can be reasonably expected to result in significant injury to the user.

**Eaton's Electrical Group
Electronics Division**
114 Old State Road
Ellisville, MO 63021
United States
www.eaton.com/elx

© 2014 Eaton
All Rights Reserved
Publication No. 10338 — BU-SB14695
October 2014

Eaton is a registered trademark.

All other trademarks are property of their respective owners.



Powering Business Worldwide

www.eaton.com/elx