

**FEATURES**

- 16 × 16 high speed, nonblocking switch array**
- Pinout and functionally equivalent to the [AD8114/AD8115](#)**
- Complete solution**
  - Buffered inputs**
  - Programmable high impedance outputs**
  - 16 output amplifiers, G = +1 ([ADV3226](#)), G = +2 ([ADV3227](#))**
  - Drives 150 Ω loads**
- Operates on ±5 V supplies**
- Low power: 1.3 W**
- Excellent ac performance**
  - −3 dB bandwidth**
  - 200 mV p-p: 820 MHz ([ADV3226](#)), 750 MHz ([ADV3227](#))**
  - 2 V p-p: 600 MHz ([ADV3226](#)), 750 MHz ([ADV3227](#))**
  - Slew rate: 2150 V/μs ([ADV3226](#)), 2950 V/μs ([ADV3227](#))**
- Serial or parallel programming of switch array**
- 100-lead LFCSP (12 mm × 12 mm)**

**APPLICATIONS**

- Routing of high speed signals including**
  - Video (NTSC, PAL, S, SECAM, YUV, RGB)**
  - Compressed video (MPEG, wavelet)**
  - 3-level digital video (HDB3)**
- Data communications**
- Telecommunications**

**GENERAL DESCRIPTION**

The [ADV3226/ADV3227](#) are high speed 16 × 16 analog crosspoint switch matrices. They offer a −3 dB signal bandwidth greater than 750 MHz and channel switch times of less than 20 ns with 1% settling.

The [ADV3226/ADV3227](#) include 16 independent output buffers that can be placed into a high impedance state for paralleling crosspoint outputs to prevent off channels from loading the output bus. The [ADV3226](#) has a gain of +1 and the [ADV3227](#) has a gain of +2. They both operate on voltage supplies of ±5 V

**FUNCTIONAL BLOCK DIAGRAM**

Figure 1.

while consuming only 118 mA ([ADV3226](#)) and 133 mA ([ADV3227](#)) of idle current. Channel switching is performed via a serial digital control that can accommodate daisy chaining of several devices or via a parallel control to allow updating of an individual output without reprogramming the entire array.

The [ADV3226/ADV3227](#) are available in the 100-lead LFCSP package over the extended industrial temperature range of −40°C to +85°C.

**TABLE OF CONTENTS**

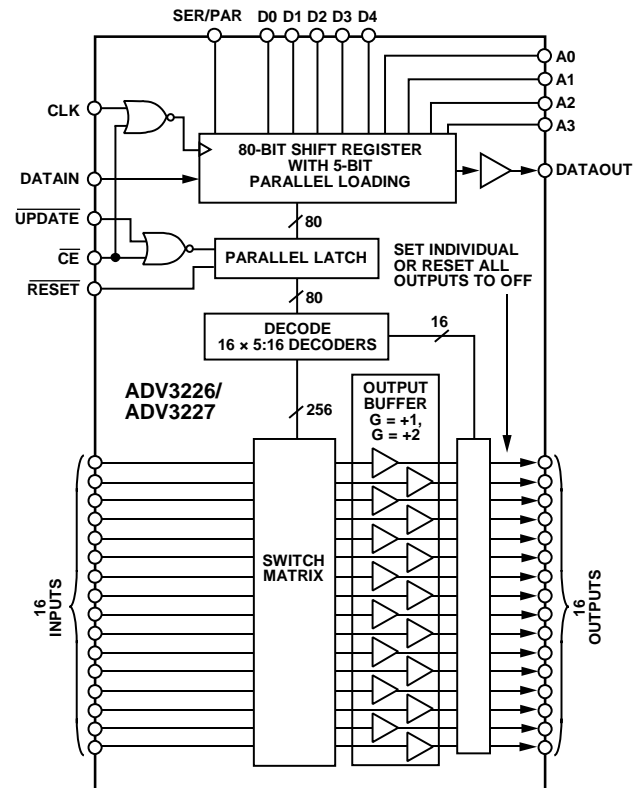
Features .....	1	ESD Caution.....	7
Applications.....	1	Pin Configuration and Function Descriptions.....	8
General Description .....	1	Truth Table and Logic Diagram .....	10
Functional Block Diagram .....	1	Typical Performance Characteristics .....	11
Revision History .....	2	Circuit Diagrams .....	20
Specifications.....	3	Theory of Operation .....	21
Timing Characteristics (Serial) .....	5	Applications Information .....	21
Logic Levels .....	5	Power-On Reset .....	22
Timing Characteristics (Parallel) .....	6	Gain Selection .....	22
Absolute Maximum Ratings.....	7	Creating Larger Crosspoint Arrays.....	23
Thermal Resistance .....	7	Outline Dimensions .....	24
Power Dissipation.....	7	Ordering Guide .....	24

**REVISION HISTORY**

**1/16—Rev. 0 to Rev. A**

Change to Maximum Potential Difference (DVCC – AVEE) Parameter, Table 5.....	7
Updated Outline Dimensions .....	24

**4/10—Revision 0: Initial Version**

## SPECIFICATIONS

$V_S = \pm 5\text{ V}$ ,  $T_A = +25^\circ\text{C}$ ,  $R_L = 150\ \Omega$ , unless otherwise noted.

Table 1.

Parameter	Test Conditions/Comments	ADV3226			ADV3227			Unit
		Min	Typ	Max	Min	Typ	Max	
<b>DYNAMIC PERFORMANCE</b>								
-3 dB Bandwidth	200 mV p-p		820		750			MHz
	2 V p-p		600		750			MHz
Gain Flatness	0.1 dB, 2 V p-p		130		60			MHz
	0.5 dB, 2 V p-p, $C_L = 2.2\ \text{pF}$		400		200			MHz
Propagation Delay	2 V p-p		0.6		0.6			ns
Settling Time	1%, 2 V step		3		3			ns
Slew Rate	2 V step, peak		2150		2950			V/ $\mu\text{s}$
<b>NOISE/DISTORTION PERFORMANCE</b>								
Differential Gain Error	NTSC or PAL		0.04		0.02			%
Differential Phase Error	NTSC or PAL		0.01		0.01			Degrees
Crosstalk, All Hostile	$f = 100\ \text{MHz}$		-45		-35			dB
	$f = 5\ \text{MHz}$		-75		-60			dB
Off Isolation, Input to Output	$f = 100\ \text{MHz}$ , one channel		-80		-75			dB
IMD2	$f = 100\ \text{MHz}$ , $R_L = 100\ \Omega$				47			dBm
	$f = 500\ \text{MHz}$ , $R_L = 100\ \Omega$				22			dBm
IMD3	$f = 100\ \text{MHz}$ , $R_L = 100\ \Omega$				42			dBm
	$f = 500\ \text{MHz}$ , $R_L = 100\ \Omega$				14			dBm
Output 1 dB Compression Point	$f = 100\ \text{MHz}$ , $R_L = 100\ \Omega$				18			dBm
	$f = 500\ \text{MHz}$ , $R_L = 100\ \Omega$				9			dBm
Input Voltage Noise	0.01 MHz to 50 MHz		16		16			nV/ $\sqrt{\text{Hz}}$
<b>DC PERFORMANCE</b>								
Gain Error			0.1	1.0	0.4	1.5		%
Gain Matching	Channel-to-channel			1.0		1.5		%
Gain Temperature Coefficient			0.8		16			ppm/ $^\circ\text{C}$
<b>OUTPUT CHARACTERISTICS</b>								
Output Resistance	DC, enabled		0.2		0.2			$\Omega$
	DC, disabled		10		5			M $\Omega$
Output Disabled Capacitance			2.7		2.7			pF
Output Leakage Current	Output disabled		1		1			$\mu\text{A}$
Output Voltage Range	No load		$\pm 3$		$\pm 3$			V
	$R_L = 150\ \Omega$		$\pm 2.8$		$\pm 2.8$			V
	Short-circuit current		55		55			mA
<b>INPUT CHARACTERISTICS</b>								
Input Offset Voltage	Worst case (all configurations)		$\pm 5$		$\pm 5$			mV
Input Offset Voltage Drift			8		8			$\mu\text{V}/^\circ\text{C}$
Input Voltage Range	No load		$\pm 3$		$\pm 1.5$			V
	$R_L = 150\ \Omega$		$\pm 3$		$\pm 1.5$			V
Input Capacitance	Any switch configuration		2.1		2.1			pF
Input Resistance			2		2			M $\Omega$
Input Bias Current	Any switch configuration		1		1			$\mu\text{A}$
<b>SWITCHING CHARACTERISTICS</b>								
Enable/Disable Time	50% <u>UPDATE</u> to 1% settling		20		20			ns
Switching Time, 2 V Step	50% <u>UPDATE</u> to 1% settling		20		20			ns
Switching Transient (Glitch)			40		65			mV p-p

Parameter	Test Conditions/Comments	ADV3226			ADV3227			Unit
		Min	Typ	Max	Min	Typ	Max	
<b>POWER SUPPLIES</b>								
Supply Current	AVCC, outputs enabled, no load		110	130		125	140	mA
	AVCC, outputs disabled		25	35		25	35	mA
	AVEE, outputs enabled, no load		110	130		125	140	mA
	AVEE, outputs disabled		25	35		25	35	mA
	DVCC, outputs enabled, no load		8	10		8	10	mA
Supply Voltage Range		±4.5	±5	±5.5	±4.5	±5	±5.5	V
PSRR	DC to 50 kHz, AVCC, AVEE		>60			>60		dB
	f = 100 kHz, AVCC, AVEE		55			60		dB
	f = 10 MHz, AVCC		45			40		dB
	f = 10 MHz, AVEE		35			55		dB
	f = 100 kHz, DVCC		90			80		dB
<b>OPERATING TEMPERATURE RANGE</b>								
Temperature Range $\theta_{JA}$	Operating (still air)	-40		+85	-40		+85	°C
	Operating (still air)		26			26		°C/W

**TIMING CHARACTERISTICS (SERIAL)**

Table 2.

Parameter	Symbol	Min	Typ	Max	Unit
Serial Data Setup Time	$t_1$	10			ns
CLK Pulse Width	$t_2$	10			ns
Serial Data Hold Time	$t_3$	10			ns
CLK Pulse Separation, Serial Mode	$t_4$	10			ns
CLK to $\overline{\text{UPDATE}}$ Delay	$t_5$	10			ns
$\overline{\text{UPDATE}}$ Pulse Width	$t_6$	10			ns
CLK to DATAOUT Valid, Serial Mode	$t_7$			50	ns
Propagation Delay, $\overline{\text{UPDATE}}$ to Switch On or Off			20		ns
Data Load Time, CLK = 5 MHz, Serial Mode			1.6		$\mu\text{s}$
CLK, $\overline{\text{UPDATE}}$ Rise and Fall Times				50	ns
RESET Time			30		ns

**Timing Diagram—Serial Mode**

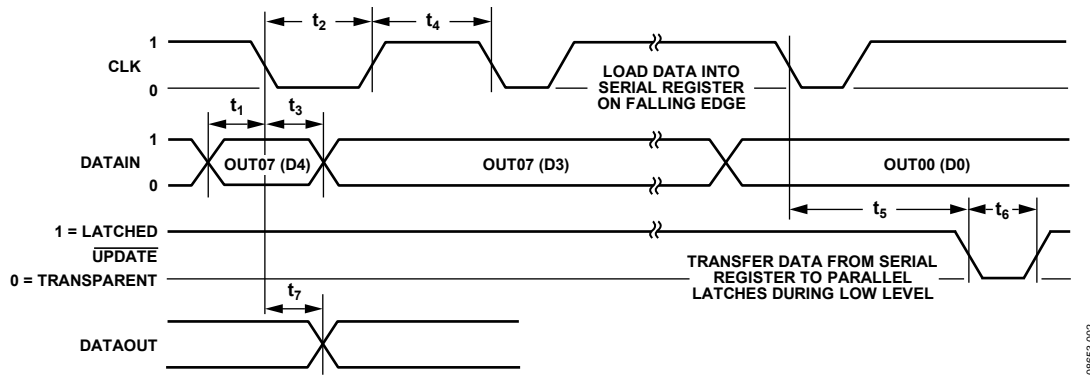

Figure 2. Timing Diagram, Serial Mode

**LOGIC LEVELS**

Table 3. Logic Levels

$V_{IH}$	$V_{IL}$	$V_{OH}$	$V_{OL}$	$I_{IH}$	$I_{IL}$	$I_{IH}$	$I_{IL}$	$I_{OH}$	$I_{OL}$
RESET, SER/PAR, CLK, DATAIN, CE, UPDATE	RESET, SER/PAR, CLK, DATAIN, CE, UPDATE	DATAOUT	DATAOUT	SER/PAR, CLK, DATAIN, CE, UPDATE	SER/PAR, CLK, DATAIN, CE, UPDATE	RESET	RESET	DATAOUT	DATAOUT
2.0 V min	0.8 V max	2.4 V min	0.4 V max	2 $\mu\text{A}$ max	2 $\mu\text{A}$ max	2 $\mu\text{A}$ max	300 $\mu\text{A}$ max	3 mA min	1 mA min

**TIMING CHARACTERISTICS (PARALLEL)**

Table 4.

Parameter	Symbol	Min	Typ	Max	Unit
Parallel Data Setup Time	$t_{1d}$	10			ns
Address Setup Time	$t_{1a}$	10			ns
CLK Pulse Width	$t_2$	10			ns
Parallel Data Hold Time	$t_{3d}$	10			ns
Address Hold Time	$t_{3a}$	10			ns
CLK Pulse Separation	$t_4$	20			ns
$\overline{\text{UPDATE}}$ Pulse Width	$t_5$	10			ns
CLK, $\overline{\text{UPDATE}}$ Rise and Fall Times				50	ns
$\overline{\text{RESET}}$ Time			30		ns

**Timing Diagram—Parallel Mode**

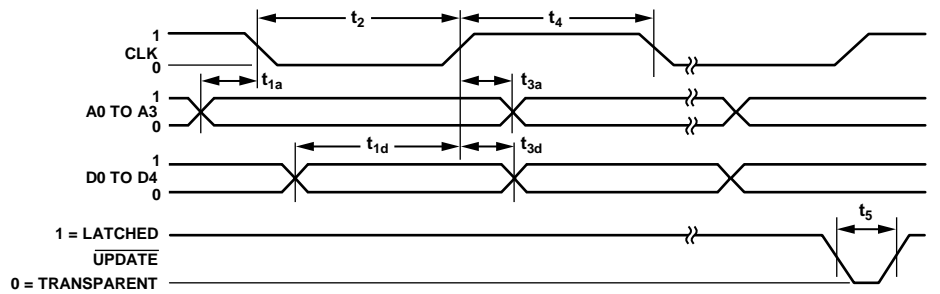

Figure 3. Timing Diagram, Parallel Mode

08653-003

## ABSOLUTE MAXIMUM RATINGS

Table 5.

Parameter	Rating
Analog Supply Voltage (AVCC – AVEE)	11 V
Digital Supply Voltage (DVCC – DGND)	6 V
Supply Potential Difference (AVCC – DVCC)	±0.5 V
Ground Potential Difference (AGND – DGND)	±0.5 V
Maximum Potential Difference (DVCC – AVEE)	11 V
Analog Input Voltage	$AVEE < V_{IN} < AVCC$
Digital Input Voltage	$DGND < D_{IN} < DVCC$
Exposed Paddle Voltage	$AVEE < V_{IN} < AVCC$
Output Voltage (Disabled Analog Output)	$AVEE < V_{OUT} < AVCC$
Output Short-Circuit	
Duration	Momentary
Current	Internally limited to 55 mA
Temperature	
Storage Temperature Range	–65°C to +125°C
Operating Temperature Range	–40°C to +85°C
Junction Temperature	150°C
Lead Temperature (Soldering, 10 sec)	300°C

Stresses at or above those listed under Absolute Maximum Ratings may cause permanent damage to the product. This is a stress rating only; functional operation of the product at these or any other conditions above those indicated in the operational section of this specification is not implied. Operation beyond the maximum operating conditions for extended periods may affect product reliability.

### THERMAL RESISTANCE

$\theta_{JA}$  is specified for the worst-case conditions, that is, a device soldered in a circuit board for surface-mount packages.

Table 6. Thermal Resistance

Package Type	$\theta_{JA}$	$\theta_{JC}$	$\theta_{JB}$	$\psi_{JT}$	$\psi_{JB}$	Unit
100-Lead LFCSP	26	2.56	9.5	0.2	8.9	°C/W

### POWER DISSIPATION

The [ADV3226/ADV3227](#) operate with ±5 V supplies and can drive loads down to 100  $\Omega$ , resulting in a wide range of possible power dissipations. For this reason, extra care must be taken when derating the operating conditions based on ambient temperature.

Packaged in the 100-lead LFCSP, the [ADV3226/ADV3227](#) junction-to-ambient thermal impedance ( $\theta_{JA}$ ) is 26°C/W. For long-term reliability, the maximum allowed junction temperature of the die should not exceed 125°C; even temporarily exceeding this limit can cause a shift in parametric performance due to a change in stresses exerted on the die by the package. Exceeding a junction temperature of 150°C for an extended period can result in device failure. In Figure 4, the curve shows the range of allowed internal die power dissipation that meets these conditions over the –40°C to +85°C ambient temperature range. When using Figure 4, do not include the external load power in the maximum power calculation, but do include the load current dropped on the die output transistors.

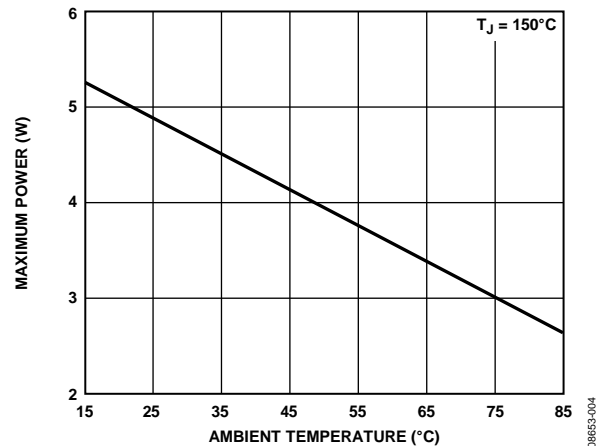

Figure 4. Maximum Die Power Dissipation vs. Ambient Temperature

### ESD CAUTION



**ESD (electrostatic discharge) sensitive device.** Charged devices and circuit boards can discharge without detection. Although this product features patented or proprietary protection circuitry, damage may occur on devices subjected to high energy ESD. Therefore, proper ESD precautions should be taken to avoid performance degradation or loss of functionality.

### PIN CONFIGURATION AND FUNCTION DESCRIPTIONS

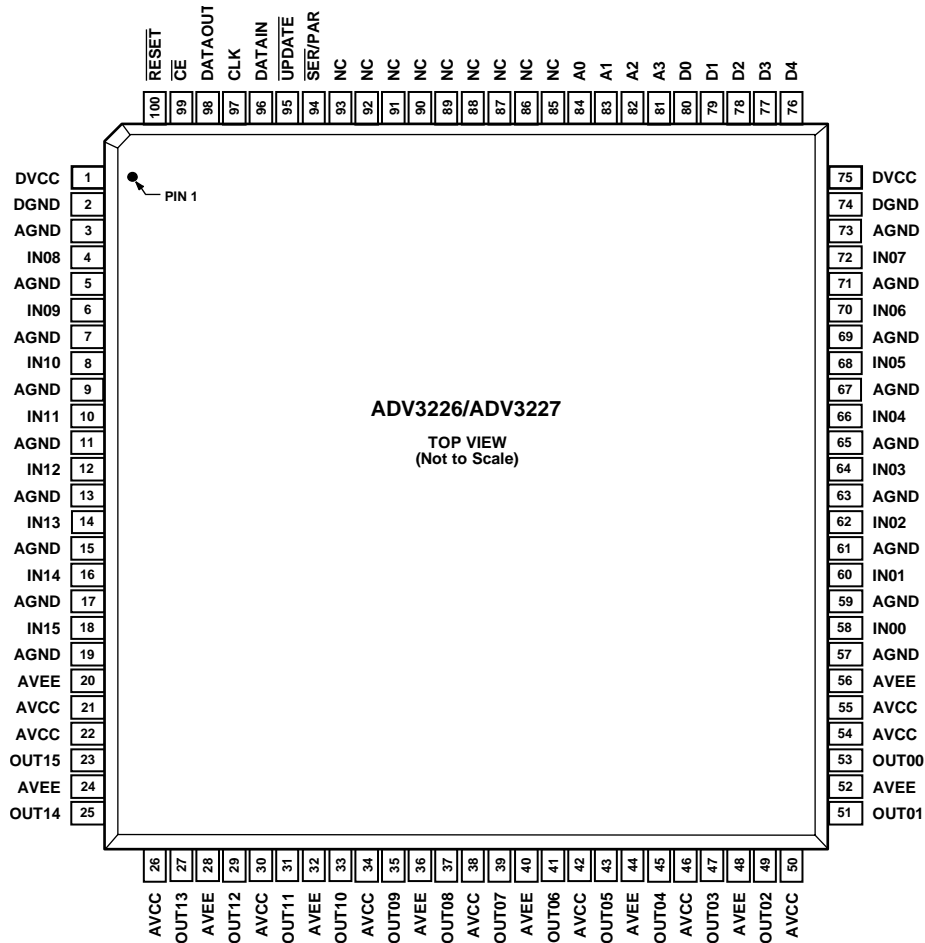

- NOTES**  
 1. NC = NO CONNECT.  
 2. THE EXPOSED METAL PADDLE ON THE BOTTOM OF THE LFCSP PACKAGE MUST BE SOLDERED TO PCB GROUND FOR PROPER HEAT DISSIPATION AND ALSO FOR NOISE AND MECHANICAL STRENGTH BENEFITS.

08653-005

Figure 5. Pin Configuration

Table 7. Pin Function Descriptions

Pin No.	Mnemonic	Description	Pin No.	Mnemonic	Description
1	DVCC	Digital Positive Power Supply.	18	IN15	Input Number 15.
2	DGND	Digital Ground.	19	AGND	Analog Ground.
3	AGND	Analog Ground.	20	AVEE	Analog Negative Supply.
4	IN08	Input Number 8.	21	AVCC	Analog Positive Supply
5	AGND	Analog Ground.	22	AVCC	Analog Positive Supply.
6	IN09	Input Number 9.	23	OUT15	Output Number 15.
7	AGND	Analog Ground.	24	AVEE	Analog Negative Supply.
8	IN10	Input Number 10.	25	OUT14	Output Number 14.
9	AGND	Analog Ground.	26	AVCC	Analog Positive Supply.
10	IN11	Input Number 11.	27	OUT13	Output Number 13.
11	AGND	Analog Ground.	28	AVEE	Analog Negative Supply.
12	IN12	Input Number 12.	29	OUT12	Output Number 12.
13	AGND	Analog Ground.	30	AVCC	Analog Positive Supply.
14	IN13	Input Number 13.	31	OUT11	Output Number 11.
15	AGND	Analog Ground.	32	AVEE	Analog Negative Supply.
16	IN14	Input Number 14.	33	OUT10	Output Number 10.
17	AGND	Analog Ground.	34	AVCC	Analog Positive Supply.



Pin No.	Mnemonic	Description	Pin No.	Mnemonic	Description
35	OUT09	Output Number 9.	69	AGND	Analog Ground.
36	AVEE	Analog Negative Supply.	70	IN06	Input Number 6.
37	OUT08	Output Number 8.	71	AGND	Analog Ground.
38	AVCC	Analog Positive Supply.	72	IN07	Input Number 7.
39	OUT07	Output Number 7.	73	AGND	Analog Ground.
40	AVEE	Analog Negative Supply.	74	DGND	Digital Ground.
41	OUT06	Output Number 6.	75	DVCC	Digital Positive Power Supply.
42	AVCC	Analog Positive Supply.	76	D4	Parallel Data Input, Output Enable.
43	OUT05	Output Number 5.	77	D3	Parallel Data Input.
44	AVEE	Analog Negative Supply.	78	D2	Parallel Data Input.
45	OUT04	Output Number 4.	79	D1	Parallel Data Input.
46	AVCC	Analog Positive Supply.	80	D0	Parallel Data Input.
47	OUT03	Output Number 3.	81	A3	Parallel Data Input.
48	AVEE	Analog Negative Supply.	82	A2	Parallel Data Input.
49	OUT02	Output Number 2.	83	A1	Parallel Data Input.
50	AVCC	Analog Positive Supply.	84	A0	Parallel Data Input.
51	OUT01	Output Number 1.	85 to 93	NC	No Connect.
52	AVEE	Analog Negative Supply.	94	$\overline{\text{SER/PAR}}$	Serial/Parallel Mode Select (Control Pin).
53	OUT00	Output Number 0.	95	$\overline{\text{UPDATE}}$	Second Rank Write Strobe (Control Pin).
54	AVCC	Analog Positive Supply.	96	DATAIN	Serial Data In (Control Pin).
55	AVCC	Analog Positive Supply.	97	CLK	Serial Data Clock. Parallel 1st rank latch enable (control pin).
56	AVEE	Analog Negative Supply.	98	DATAOUT	Serial Data Out.
57	AGND	Analog Ground.	99	$\overline{\text{CE}}$	Chip Enable (Control Pin).
58	IN00	Input Number 0.	100	$\overline{\text{RESET}}$	Second Rank Reset (Control Pin).
59	AGND	Analog Ground.	N/A <sup>1</sup>	EP	Exposed Paddle. The exposed metal paddle on the bottom of the LFCSP package must be soldered to the PCB ground for proper heat dissipation and for noise and mechanical strength benefits.
60	IN01	Input Number 1.			
61	AGND	Analog Ground.			
62	IN02	Input Number 2.			
63	AGND	Analog Ground.			
64	IN03	Input Number 3.			
65	AGND	Analog Ground.			
66	IN04	Input Number 4.			
67	AGND	Analog Ground.			
68	IN05	Input Number 5.			

<sup>1</sup> N/A means not applicable.

TRUTH TABLE AND LOGIC DIAGRAM

Table 8. Operation Truth Table<sup>1</sup>

CE	UPDATE	CLK	DATAIN	DATAOUT	RESET	SER/PAR	Description
1	X	X	X	X	X	X	No change in logic.
0	X	↓	Data <sub>i</sub> <sup>2</sup>	Data <sub>i-80</sub>	X	0	The data on the serial DATAIN line is loaded into the serial register. The first bit clocked into the serial register appears at DATAOUT 80 clock cycles later.
0	X	0	D0...D4	N/A <sup>3</sup> in parallel mode <sup>4</sup>	X	1	The data on the parallel data lines, D0 to D4, are loaded into the 80-bit serial shift register location addressed at A0 to A3.
0	0	X	X	X	1	X	Data in the 80-bit shift register transfers into the parallel latches that control the switch array. Latches are transparent.
X	X	X	X	X	0	X	Asynchronous operation. All outputs are disabled. Second rank latches are cleared. Remainder of logic is unchanged.

<sup>1</sup> X is don't care.

<sup>2</sup> Data<sub>i</sub>: serial data.

<sup>3</sup> N/A means not applicable.

<sup>4</sup> DATAOUT remains active in parallel mode and always reflects the state of the MSB of the serial shift register.

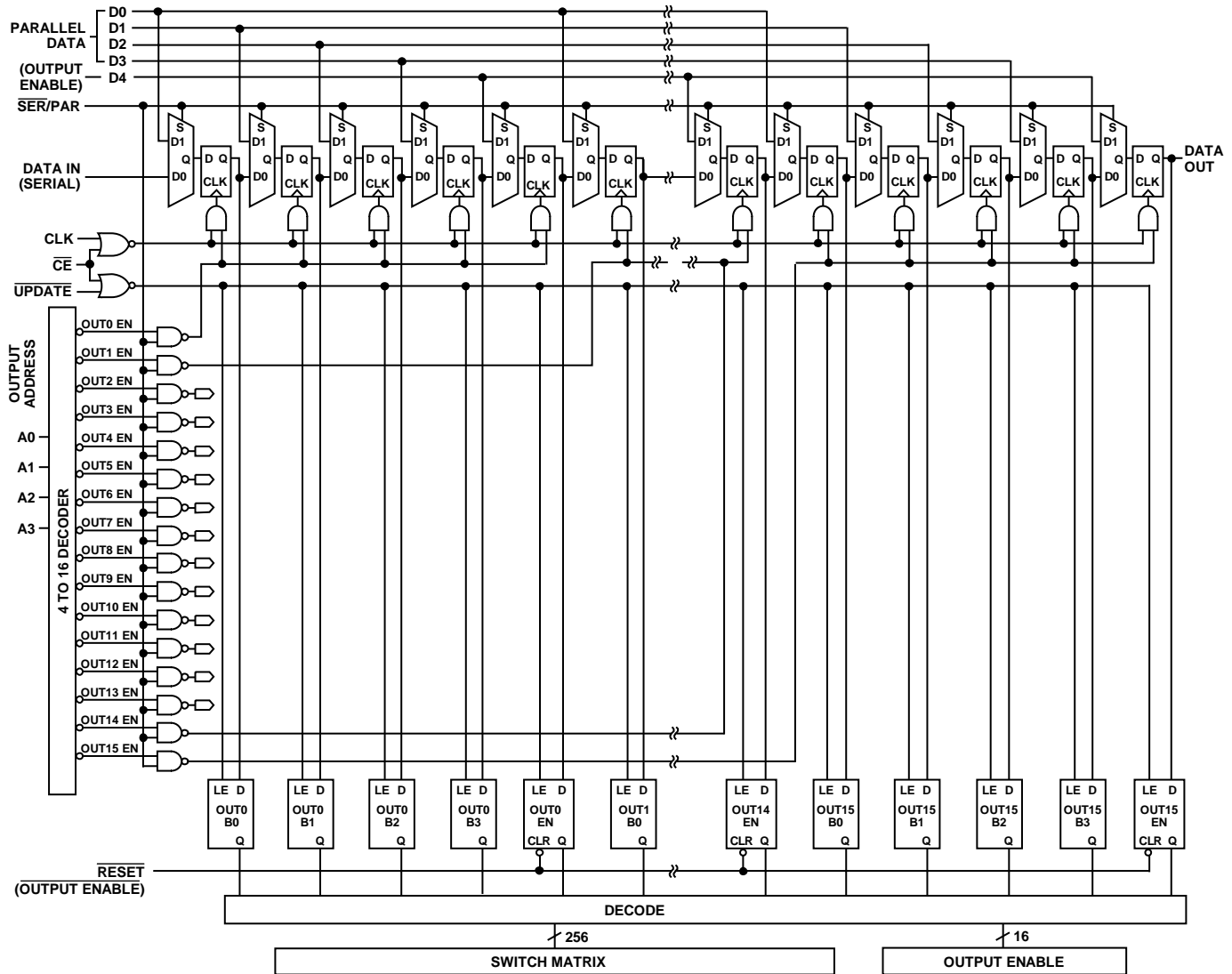

Figure 6. Logic Diagram

TYPICAL PERFORMANCE CHARACTERISTICS

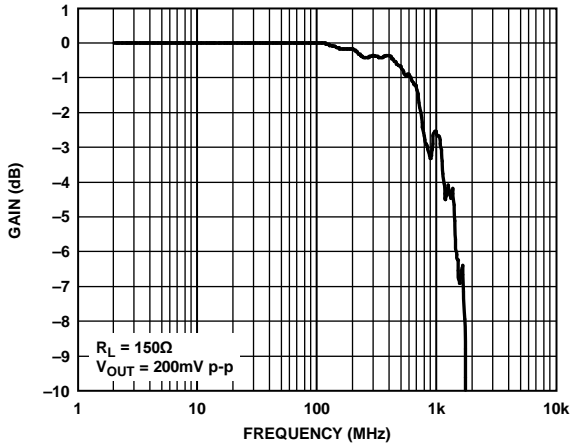

Figure 7. ADV3226 Small Signal Frequency Response

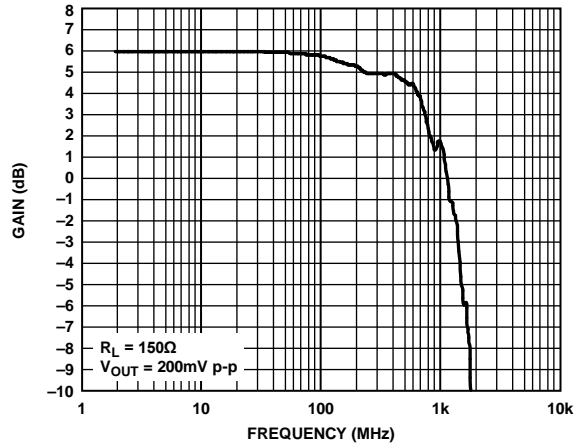

Figure 10. ADV3227 Small Signal Frequency Response

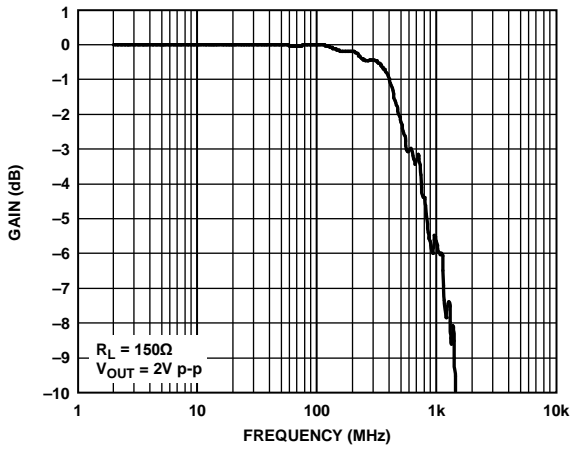

Figure 8. ADV3226 Large Signal Frequency Response

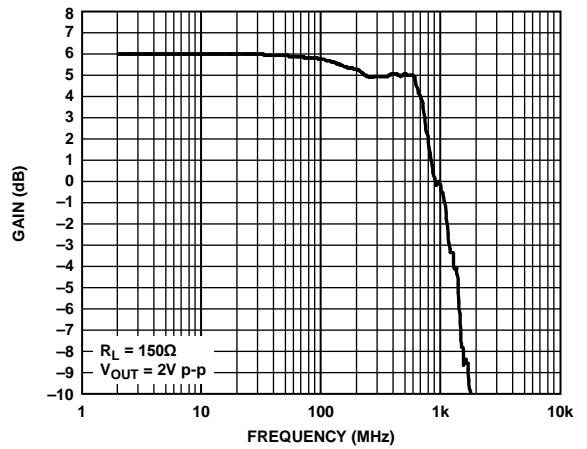

Figure 11. ADV3227 Large Signal Frequency Response

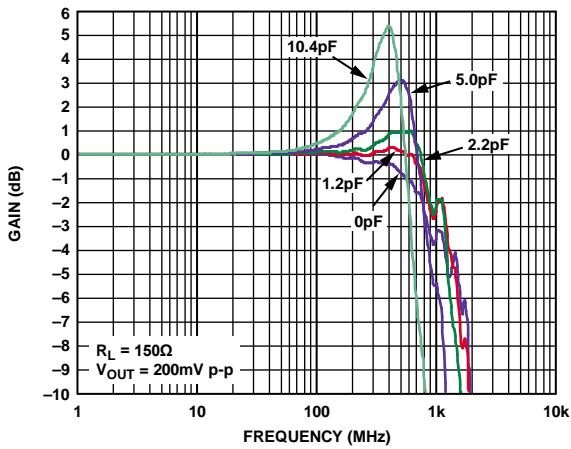

Figure 9. ADV3226 Small Signal Frequency Response with Capacitive Loads

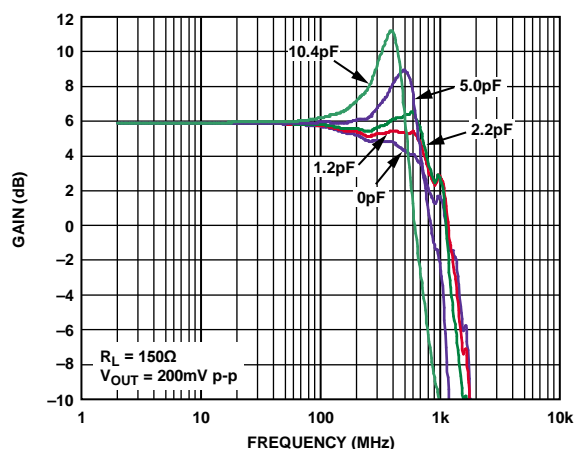

Figure 12. ADV3227 Small Signal Frequency Response,  $R_L = 150\Omega$

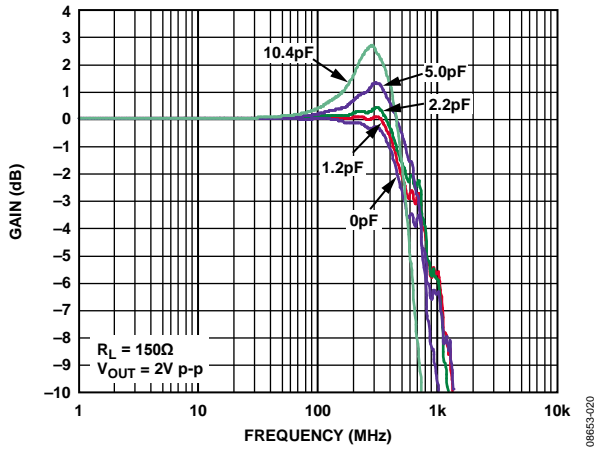

Figure 13. ADV3226 Large Signal Frequency Response with Capacitive Loads

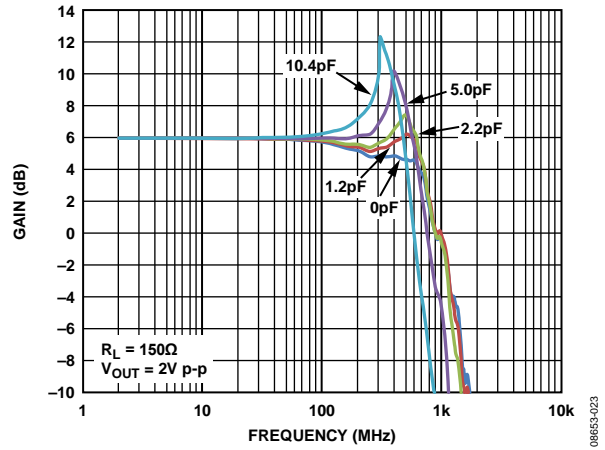

Figure 16. ADV3227 Large Signal Frequency Response with Capacitive Loads

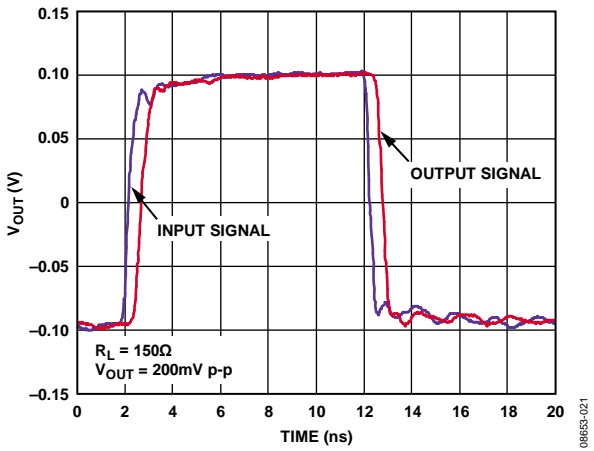

Figure 14. ADV3226 Small Signal Pulse Response

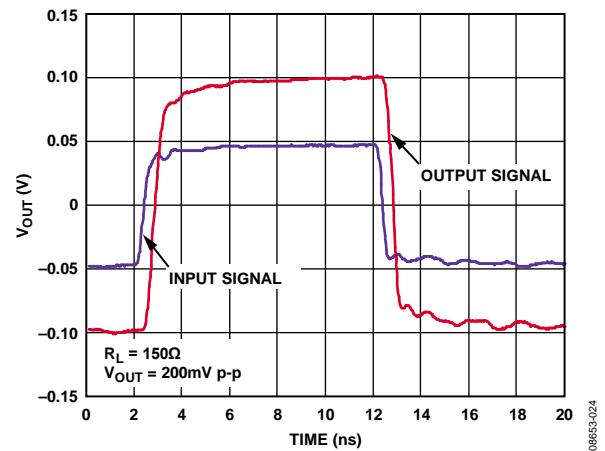

Figure 17. ADV3227 Small Signal Pulse Response

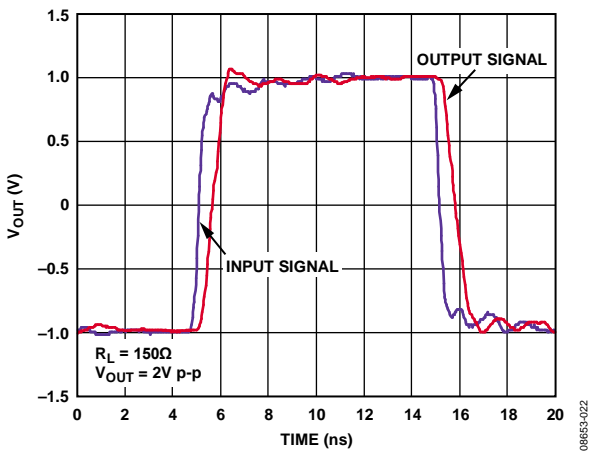

Figure 15. ADV3226 Large Signal Pulse Response

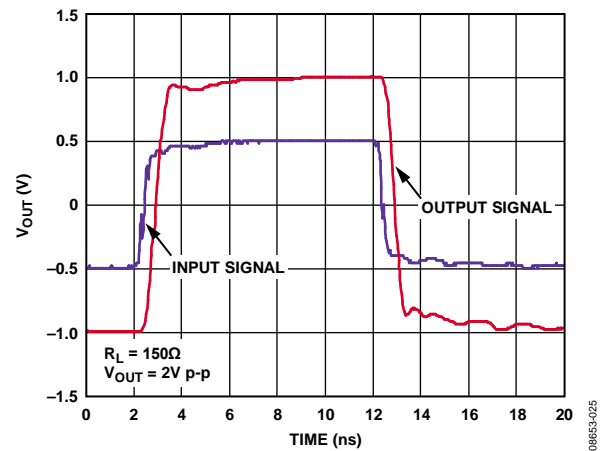

Figure 18. ADV3227 Large Signal Pulse Response

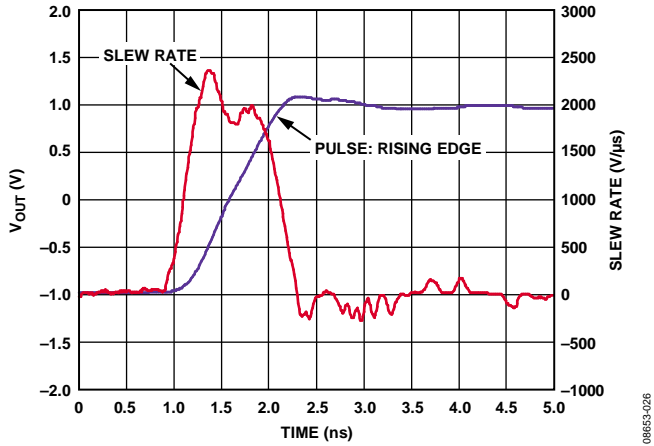

Figure 19. ADV3226 Rising Edge Slew Rate

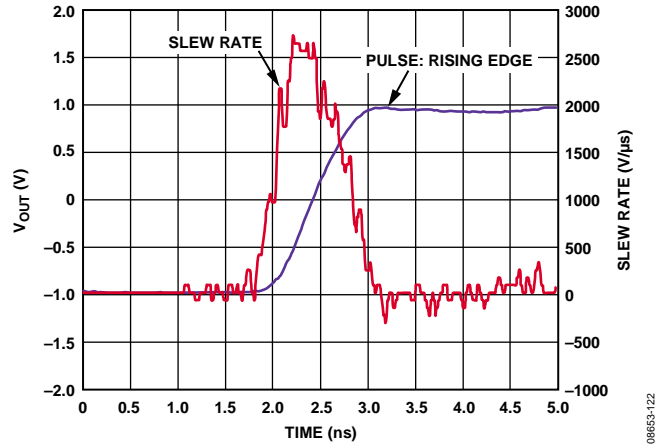

Figure 22. ADV3227 Rising Edge Slew Rate

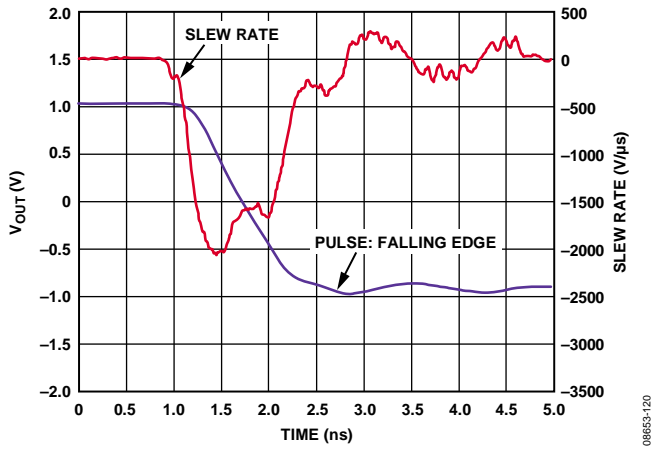

Figure 20. ADV3226 Falling Edge Slew Rate

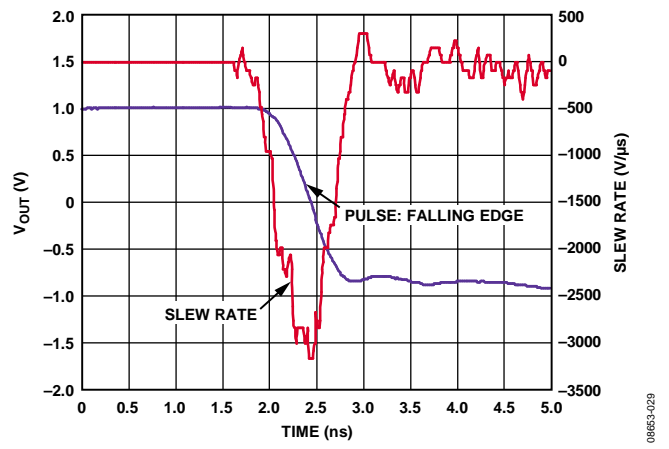

Figure 23. ADV3227 Falling Edge Slew Rate

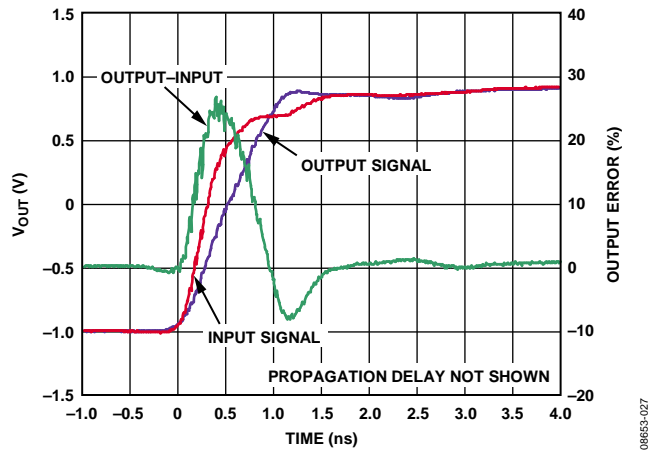

Figure 21. ADV3226 Settling Time

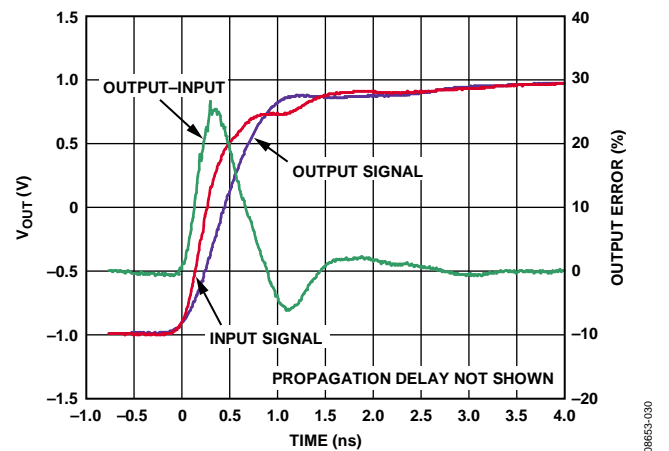

Figure 24. ADV3227 Settling Time

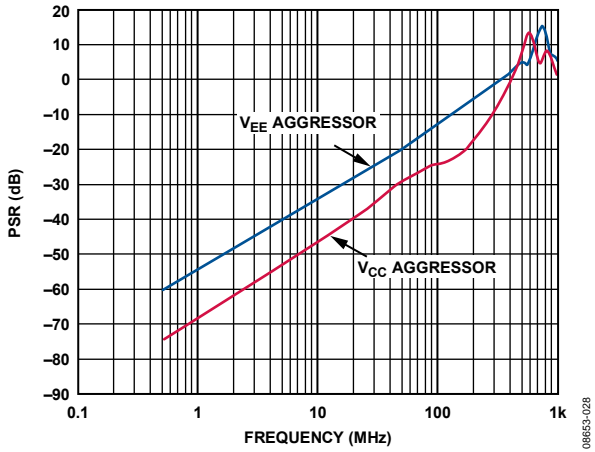

Figure 25. ADV3226 Power Supply Rejection

08653-028

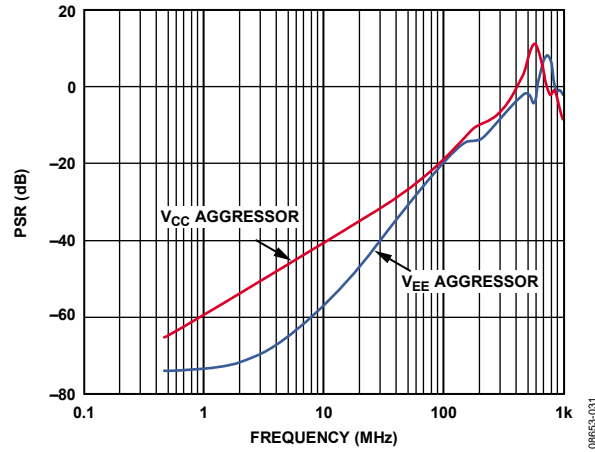

Figure 28. ADV3227 Power Supply Rejection

08653-031

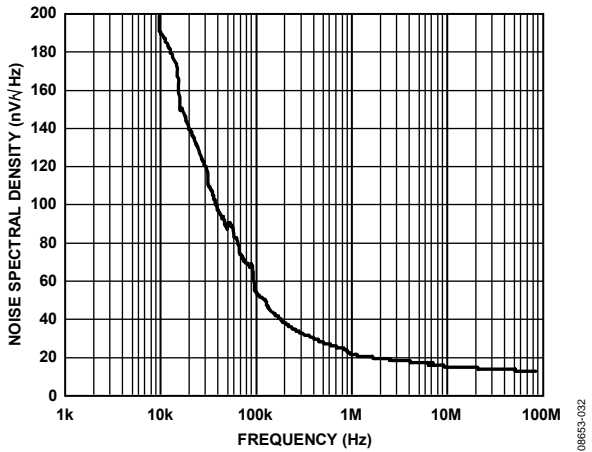

Figure 26. ADV3226 Output Noise, 100 Ω Load

08653-032

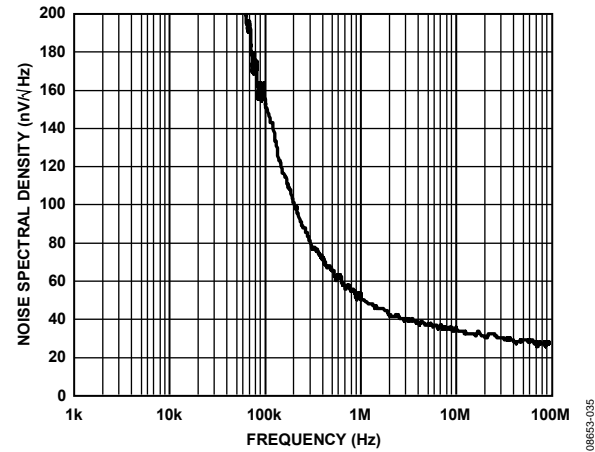

Figure 29. ADV3227 Output Noise, 100 Ω Load

08653-035

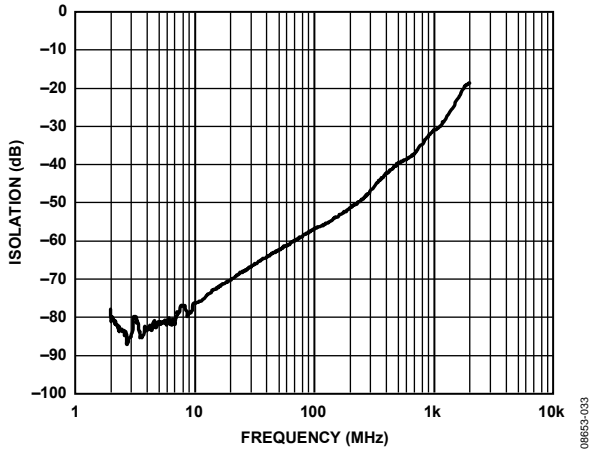

Figure 27. ADV3226 Off Isolation

08653-033

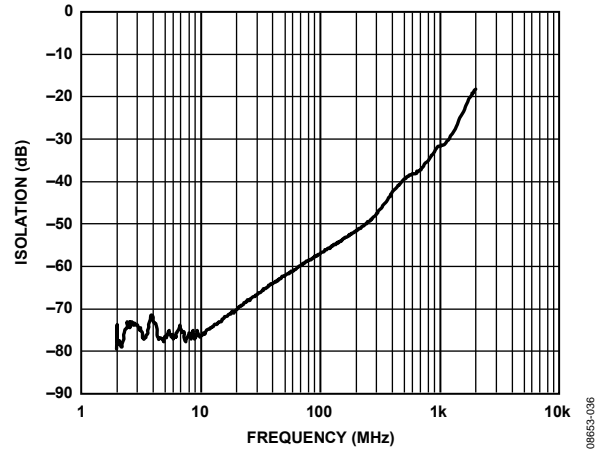

Figure 30. ADV3227 Off Isolation

08653-036

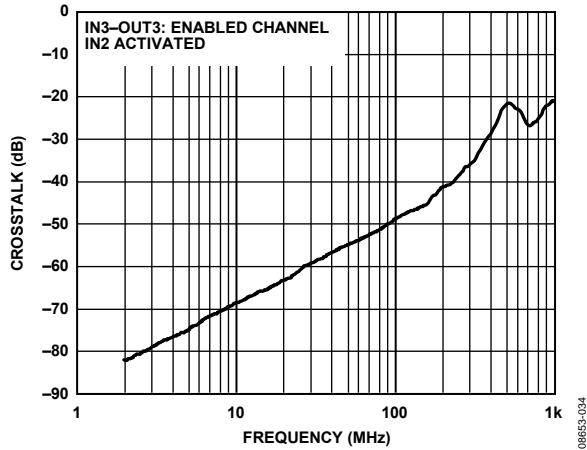

Figure 31. ADV3226 Crosstalk, One Adjacent Channel, RTO

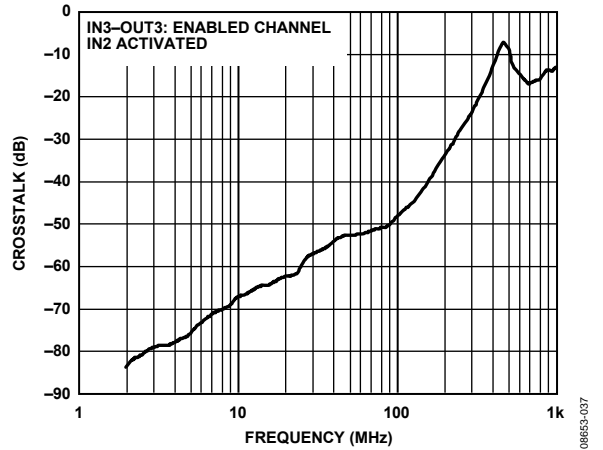

Figure 34. ADV3227 Crosstalk, One Adjacent Channel, RTO

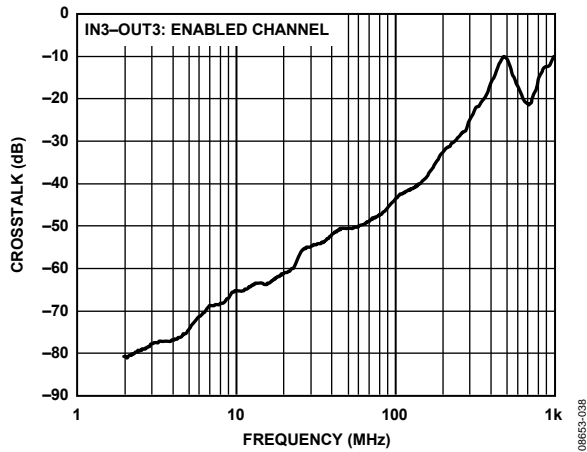

Figure 32. ADV3226 Crosstalk, All Hostile, RTO

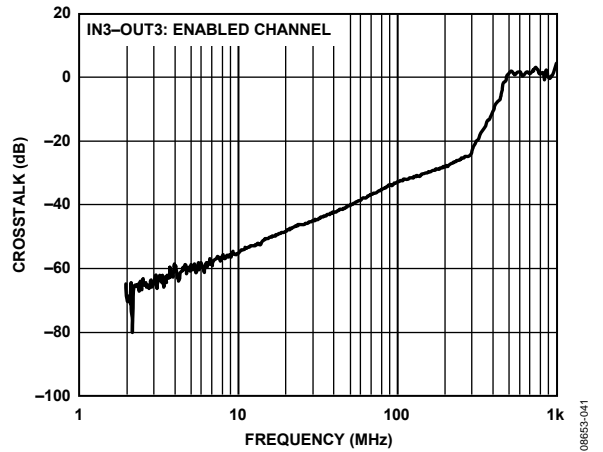

Figure 35. ADV3227 Crosstalk, All Hostile, RTO

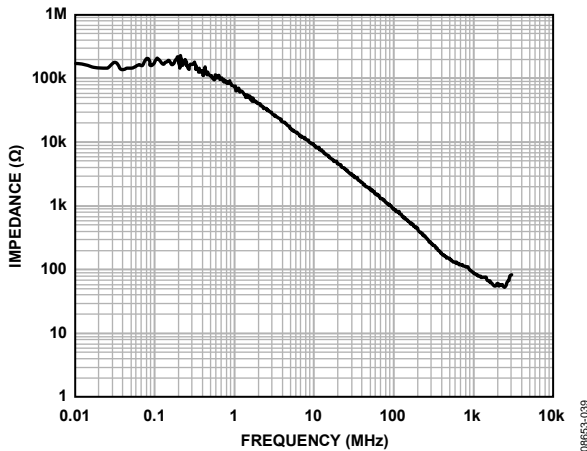

Figure 33. ADV3226 Input Impedance

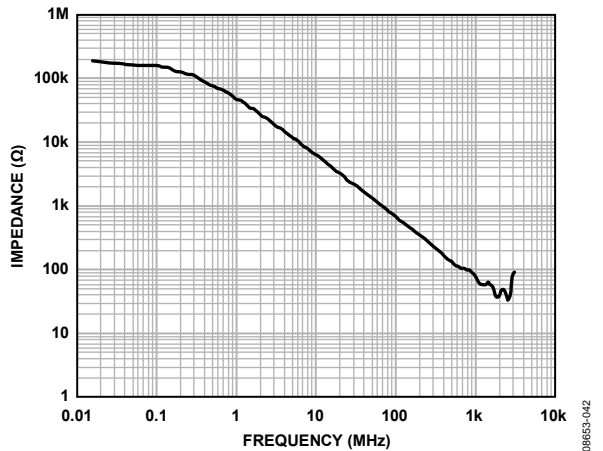

Figure 36. ADV3227 Input Impedance

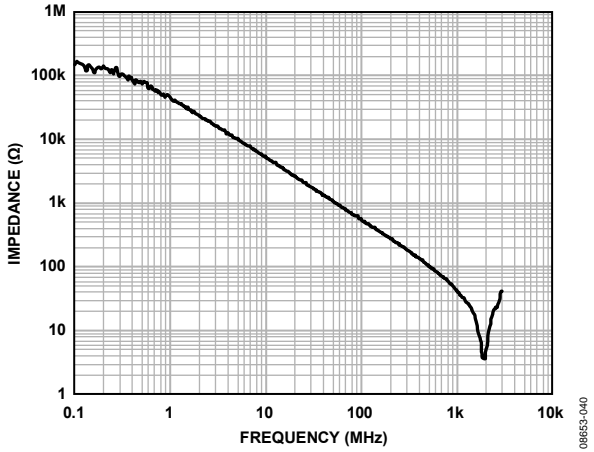

Figure 37. ADV3226 Output Impedance, Disabled

08653-040

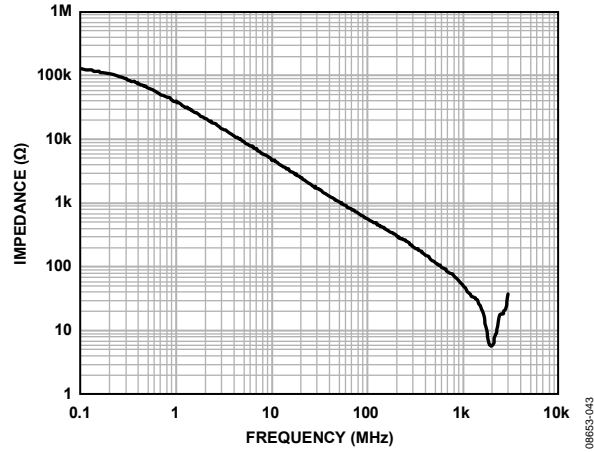

Figure 40. ADV3227 Output Impedance, Disabled

08653-043

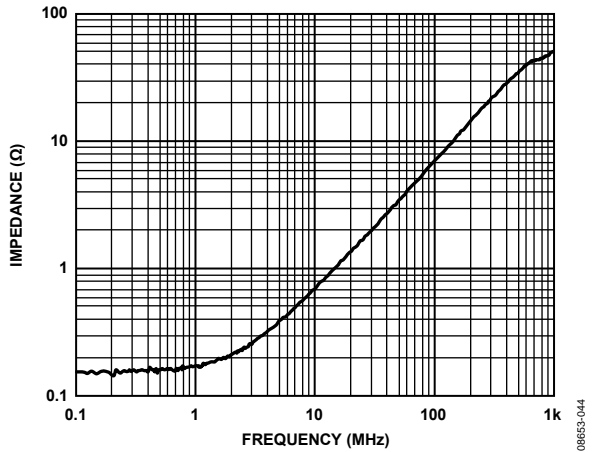

Figure 38. ADV3226 Output Impedance, Enabled

08653-044

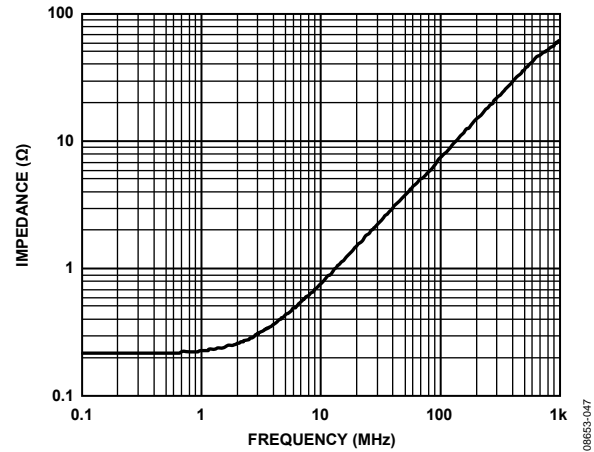

Figure 41. ADV3227 Output Impedance, Enabled

08653-047

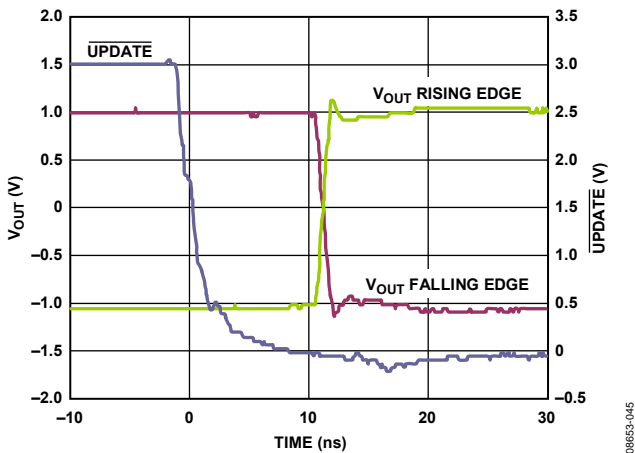

Figure 39. ADV3226 Switching Time

08653-045

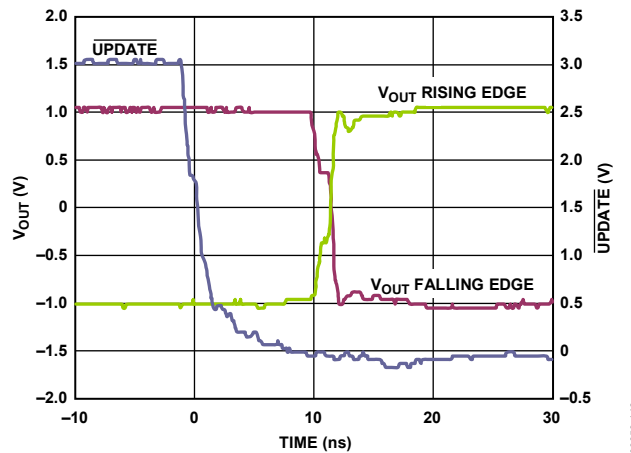

Figure 42. ADV3227 Switching Time

08653-142



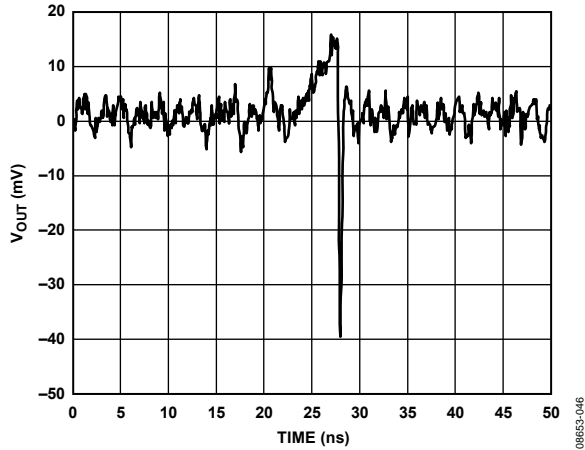

Figure 43. ADV3226 Switching Glitch

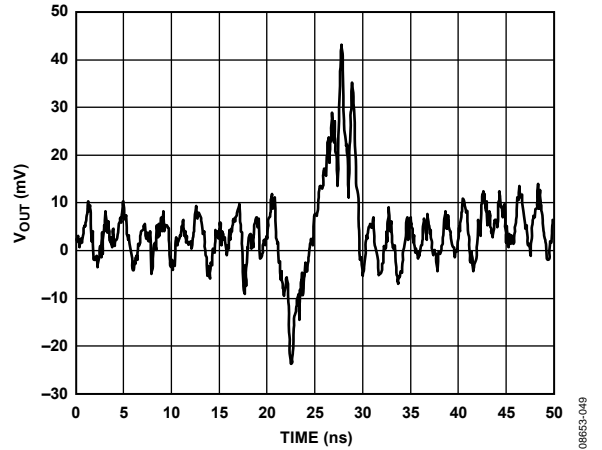

Figure 46. ADV3227 Switching Glitch

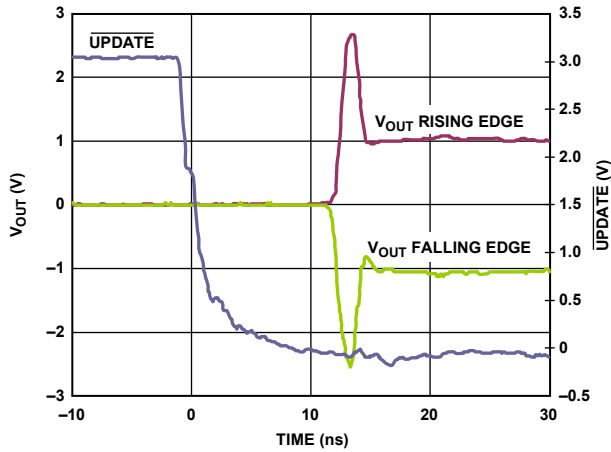

Figure 44. ADV3226 Enable Time

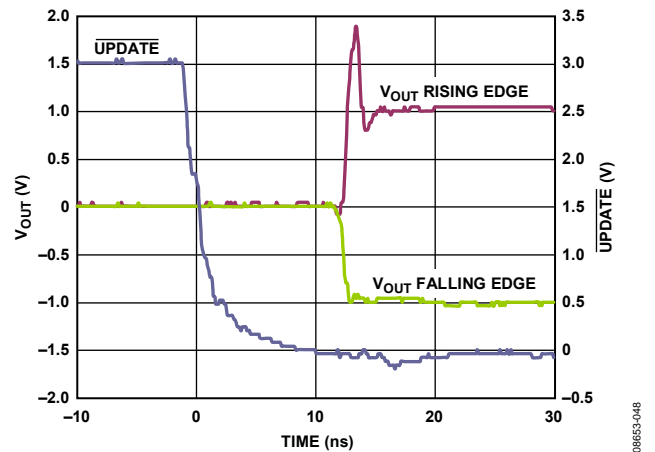

Figure 47. ADV3227 Enable Time

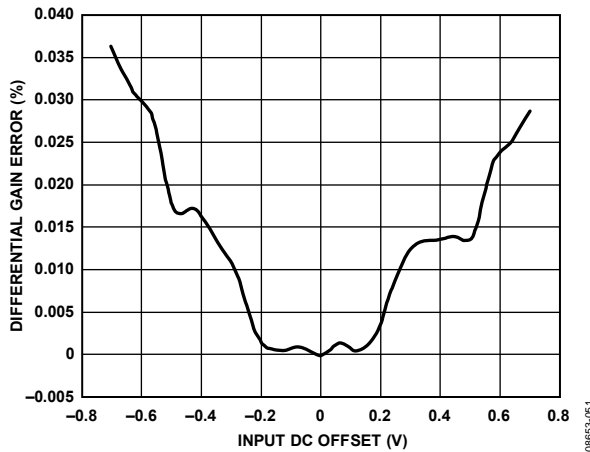

Figure 45. ADV3226 Differential Gain Error

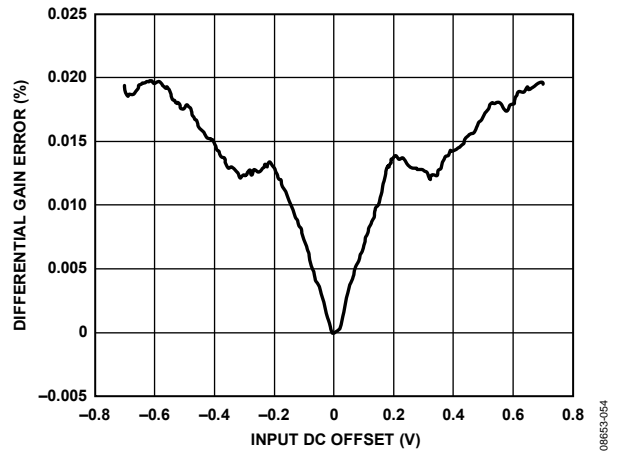

Figure 48. ADV3227 Differential Gain Error

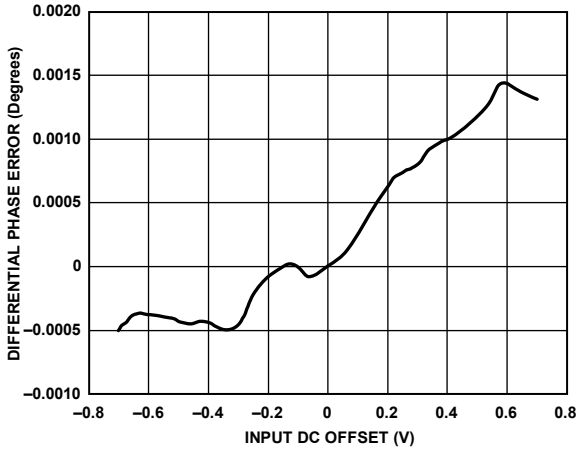

Figure 49. ADV3226 Differential Phase Error

08653-052

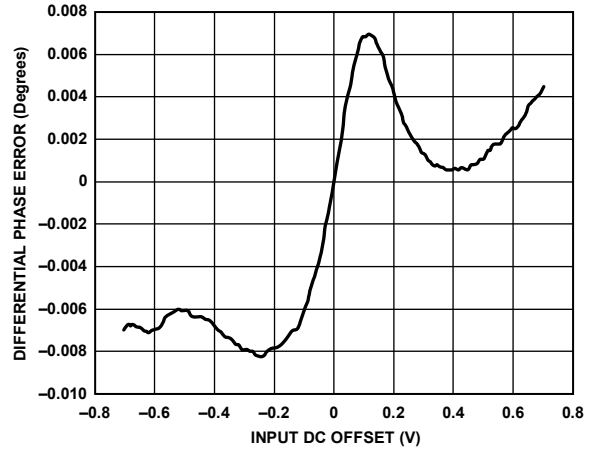

Figure 52. ADV3227 Differential Phase Error

08653-055

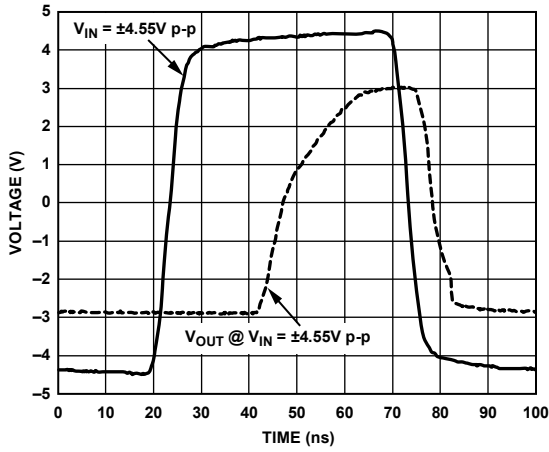

Figure 50. ADV3226 Overdrive Recovery

08653-056

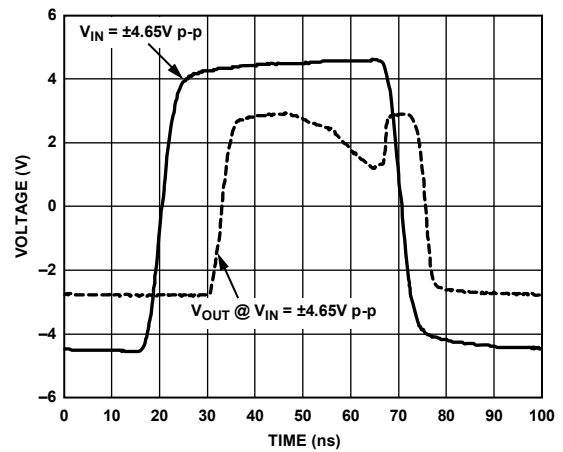

Figure 53. ADV3227 Overdrive Recovery

08653-059

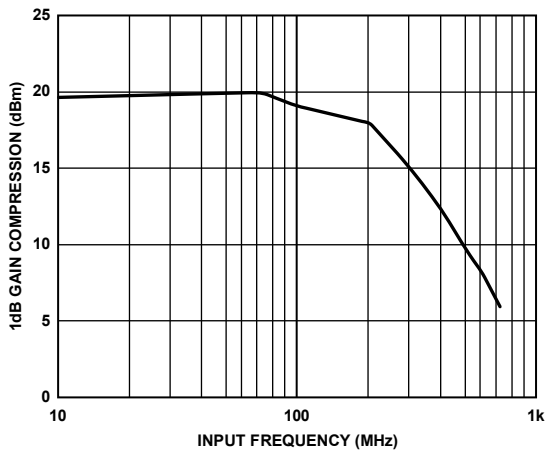

Figure 51. ADV3227 1 dB Gain Compression, 100 Ω Load

08653-057

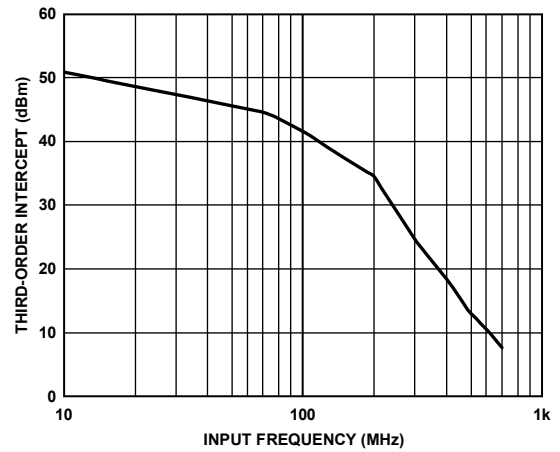

Figure 54. ADV3227 Third-Order Intercept, 100 Ω Load

08653-060

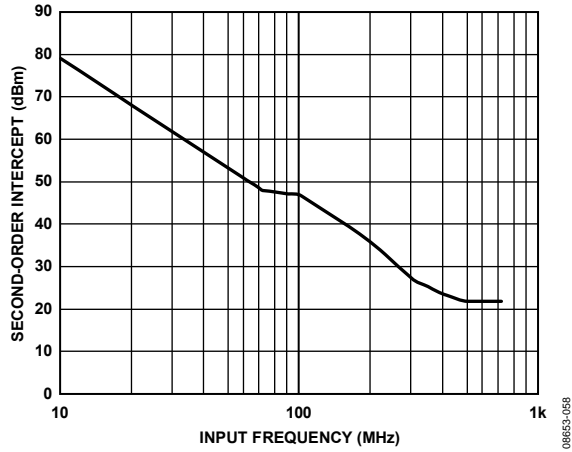

Figure 55. ADV3227 Second-Order Intercept, 100  $\Omega$  Load

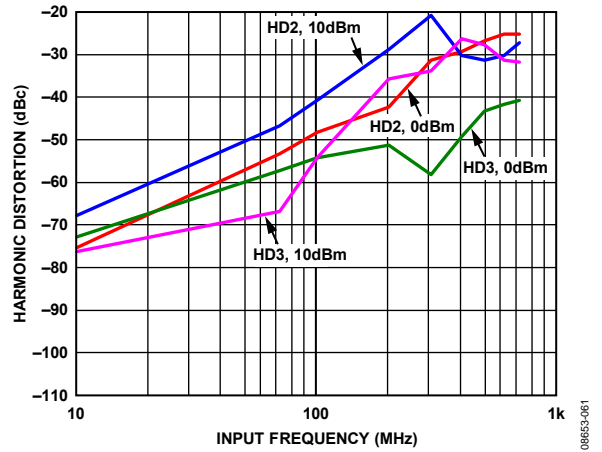

Figure 57. ADV3227 Harmonic Distortion (Input Referred), 100  $\Omega$  Load

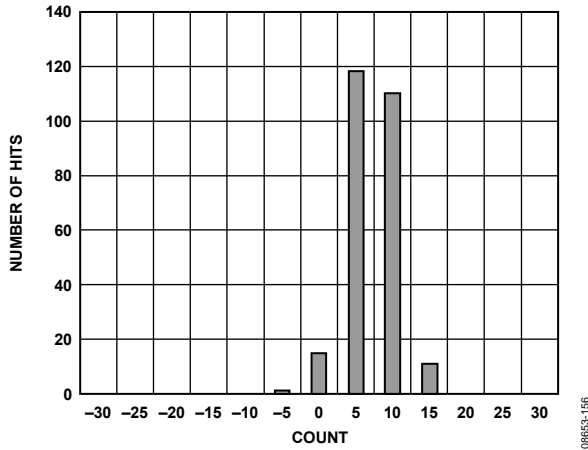

Figure 56. ADV3226 and ADV3227, Input  $V_{os}$  Distribution

CIRCUIT DIAGRAMS

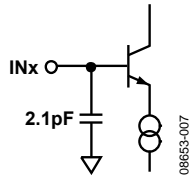

Figure 58. Analog Input

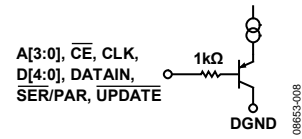

Figure 61. Logic Input

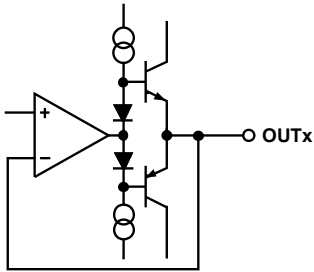

Figure 59. Analog Output Enabled

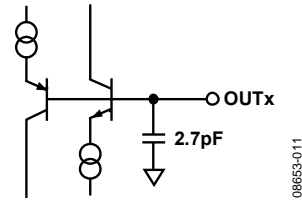

Figure 62. Analog Output Disabled

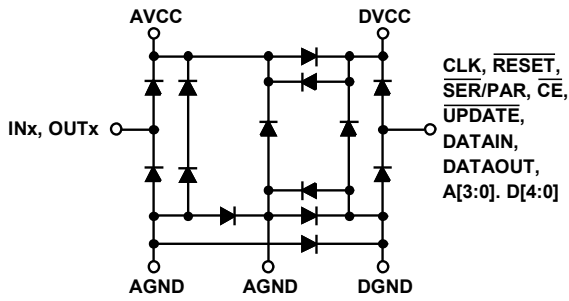

Figure 60. ESD Map

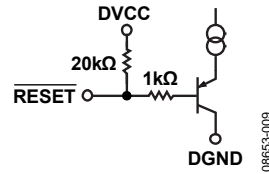

Figure 63. Reset Input

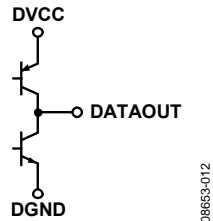

Figure 64. Logic Output

## THEORY OF OPERATION

The [ADV3226](#) ( $G = 1$ ) and [ADV3227](#) ( $G = 2$ ) are crosspoint arrays with 16 outputs, each of which can be connected to any one of 16 inputs. Organized by output row, 16 switchable input transconductance stages are connected to each output buffer to form 16-to-1 multiplexers. There are 16 of these multiplexers, each with its inputs wired in parallel, for a total array of 256 transconductance stages forming a multicast-capable crosspoint switch. Each input is buffered and is not loaded by the outputs, simplifying the construction of larger arrays using the [ADV3226](#) or [ADV3227](#) as a building block.

Decoding logic for each output selects one (or none) of the transconductance stages to drive the output stage. The enabled transconductance stage drives the output stage, and feedback forms a closed-loop amplifier. A mask programmable feedback network sets the closed-loop signal gain. For the [ADV3226](#), this gain is 1, and for the [ADV3226](#), this gain is 2.

The output stage of the [ADV3226](#) or [ADV3227](#) is designed for low differential gain and phase error when driving composite video signals. It also provides slew current for a fast pulse response when driving component video signals. Unlike many multiplexer designs, these requirements are balanced such that large signal bandwidth is very similar to small signal bandwidth. The design load is 150  $\Omega$ , but provisions are made to drive loads as low as 100  $\Omega$  when on-chip power dissipation limits are not exceeded.

The outputs of the [ADV3226/ADV3227](#) can be disabled to minimize on-chip power dissipation. When disabled, there is no feedback network loading the output. This high disabled output impedance allows multiple ICs to be bussed together without additional buffering. Care must be taken to reduce output capacitance, which results in more overshoot and frequency domain peaking.

A series of internal amplifiers drives internal nodes such that a wideband high impedance is presented at the disabled output, even while the output bus is under large signal swings. To keep these internal amplifiers in their linear range of operation when the outputs are disabled and driven externally, do not allow the voltage applied to them to exceed the valid output swing range for the [ADV3226/ADV3227](#). If the disabled outputs are left floating, they may exhibit high enable glitches. If necessary, the disabled output can be kept from drifting out of range by applying an output load resistor to ground.

The connection of the [ADV3226/ADV3227](#) is controlled by a flexible TTL-compatible logic interface. Either parallel or serial loading into a first rank of latches preprograms each output. A global update signal moves the programming data into the second rank of latches, simultaneously updating all outputs. In serial mode, a serial out pin allows devices to be daisy-chained together for single pin programming of multiple ICs. A power-on reset pin is available to avoid bus conflicts by disabling all outputs. This power-on reset clears the second rank of latches but does not clear the first rank of latches. In serial mode, preprogramming

individual inputs is not possible and the entire shift register needs to be flushed.

To easily interface to ground referenced video signals, the [ADV3226/ADV3227](#) operate on split  $\pm 5$  V supplies. The logic inputs and output run on a single +5 V supply, but the logic inputs switch at approximately 1.6 V for compatibility with a variety of logic families. The serial output buffer is a rail-to-rail output stage with 5 mA of drive capability.

## APPLICATIONS INFORMATION

The [ADV3226/ADV3227](#) have two options for changing the programming of the crosspoint matrix. In the first option, a serial word of 80 bits can be provided, which updates the entire matrix each time the 80-bit word is shifted into the part. The second option allows for changing the programming of a single output via a parallel interface. The serial option requires fewer signals but more time (clock cycles) for changing the programming, whereas the parallel programming technique requires more signals but can change a single output at a time and requires fewer clock cycles to complete the programming.

### Serial Programming

The serial programming mode uses the  $\overline{\text{CE}}$ , CLK, DATAIN, UPDATE, and SER/PAR pins. The first step is to assert a low on SER/PAR to enable the serial programming mode.  $\overline{\text{CE}}$  for the chip must be low to allow data to be clocked into the device. The  $\overline{\text{CE}}$  signal can be used to address an individual device when devices are connected in parallel.

The UPDATE signal should be high during the time that data is shifted into the serial port of the device. Although the data still shifts in when UPDATE is low, the transparent, asynchronous latches allow the shifting data to reach the matrix, which causes the matrix to try to update to every intermediate state as defined by the shifting data.

The data at DATAIN is clocked in at every falling edge of CLK. A total of 80 bits must be shifted in to complete the programming. For each of the 16 outputs, there are four bits (D0 to D3) that determine the source of its input. The MSB is shifted in first. A fifth bit (D4) precedes the four input select bits and determines the enabled state of the output. If D4 is low (output disabled), the four associated bits (D0 to D3) do not matter because no input switches to that output.

The most significant output address data is shifted in first, and the remaining addresses follow in sequence until the least significant output address data is shifted in. At this point, UPDATE can be taken low, which programs the device according to the data that was just shifted in. The update registers are asynchronous, and when UPDATE is low (and CE is low), they are transparent.

If more than one [ADV3226/ADV3227](#) device is to be serially programmed in a system, the DATAOUT signal from one device can be connected to the DATAIN of the next device to

form a serial chain. Connect all of the  $\overline{\text{CLK}}$ ,  $\overline{\text{CE}}$ ,  $\overline{\text{UPDATE}}$ , and  $\overline{\text{SER/PAR}}$  pins in parallel and operate them as described previously in this section. The serial data is input to the  $\text{DATAIN}$  pin of the first device of the chain, and it ripples through to the last. Therefore, the data for the last device in the chain should come at the beginning of the programming sequence. The length of the programming sequence (80 bits) is multiplied by the number of devices in the chain.

### Parallel Programming

When using the parallel programming mode, it is not necessary to reprogram the entire device when making changes to the matrix. Parallel programming allows the modification of a single output at a time. Because this takes only one  $\text{CLK/UPDATE}$  cycle, significant time savings can be realized by using parallel programming.

An important consideration in using parallel programming is that the  $\overline{\text{RESET}}$  signal does not reset all registers in the [ADV3226/ADV3227](#). When taken low, the  $\overline{\text{RESET}}$  signal sets each output to the disabled state. This is helpful during power-up to ensure that two parallel outputs are not active at the same time.

After initial power-up, the internal registers in the device generally contain random data, even though the  $\overline{\text{RESET}}$  signal was asserted. If parallel programming is used to program one output, that output is properly programmed, but the rest of the device has a random program state depending on the internal register content at power-up. Therefore, when using parallel programming, it is essential that all outputs be programmed to a desired state after power-up to ensure that the programming matrix is always in a known state. From this point, parallel programming can be used to modify either a single output or multiple outputs at one time.

Similarly, if both  $\overline{\text{CE}}$  and  $\overline{\text{UPDATE}}$  are taken low after initial power-up, the random power-up data in the shift register is programmed into the matrix. Therefore, to prevent programming the crosspoint into an unknown state, do not apply low logic levels to both  $\overline{\text{CE}}$  and  $\overline{\text{UPDATE}}$  after power is initially applied. To eliminate the possibility of programming the matrix to an unknown state, after initial power-up, program the full shift register one time to a desired state using either serial or parallel programming.

To change the programming of an output via parallel programming, take the  $\overline{\text{SER/PAR}}$  and  $\overline{\text{UPDATE}}$  pins high, and take the  $\overline{\text{CE}}$  pin low. The  $\text{CLK}$  signal should be in the high state. Place the 4-bit address of the output to be programmed on A0 to A3.

The first four data bits (D0 to D3) contain the information that identifies the input that is programmed to the addressed output. The fifth data bit (D4) determines the enabled state of the output. If D4 is low (output disabled), the data on D0 to D3 does not matter.

After the address and data signals are established, they can be latched into the shift register by pulling the  $\text{CLK}$  signal low; however, the matrix is not programmed until the  $\overline{\text{UPDATE}}$  signal is taken low. In this way, it is possible to latch in new data for several or all of the outputs first via successive negative transitions of  $\text{CLK}$  while  $\overline{\text{UPDATE}}$  is held high and then have all the new data take effect when  $\overline{\text{UPDATE}}$  goes low. Use this technique when programming the device for the first time after power-up when using parallel programming. In parallel mode, the  $\text{CLK}$  pin is level sensitive, whereas in serial mode, it is edge triggered.

### POWER-ON RESET

When powering up the [ADV3226/ADV3227](#), it is usually desirable to have the outputs come up in the disabled state. When taken low, the  $\overline{\text{RESET}}$  pin causes all outputs to be in the disabled state. However, the  $\overline{\text{RESET}}$  signal does not reset all registers in the [ADV3226/ADV3227](#). This is important when operating in the parallel programming mode. Refer to the Parallel Programming section for information about programming internal registers after power-up. Serial programming programs the entire matrix each time; therefore, no special considerations apply.

Because the data in the shift register is random after power-up, it should not be used to program the matrix, or the matrix can enter unknown states. To prevent the matrix from entering unknown states, do not apply logic low signals to both  $\overline{\text{CE}}$  and  $\overline{\text{UPDATE}}$  initially after power-up. Instead, first load the shift register with the data and then take  $\overline{\text{UPDATE}}$  low to program the device.

The  $\overline{\text{RESET}}$  pin has a 20 k $\Omega$  pull-up resistor to DVCC that can be used to create a simple power-up reset circuit. A capacitor from  $\overline{\text{RESET}}$  to ground holds the  $\overline{\text{RESET}}$  pin low for a period during which the rest of the device stabilizes. The low condition causes all of the outputs to be disabled. The capacitor then charges through the pull-up resistor to the high state, thereby allowing full programming capability of the device.

### GAIN SELECTION

The 16  $\times$  16 crosspoints come in two versions, depending on the gain of the analog circuit path. The [ADV3226](#) device is unity gain and can be used for analog logic switching and other applications where unity gain is desired. The [ADV3226](#) outputs have very high impedance when their outputs are disabled.

The [ADV3227](#) can be used for devices that drive a terminated cable with its outputs. This device has a built-in gain-of-2 that eliminates the need for a gain-of-2 buffer to drive a video line. Its high output disabled impedance minimizes signal degradation when paralleling additional outputs.

## CREATING LARGER CROSSPOINT ARRAYS

The [ADV3226/ADV3227](#) are high density building blocks for creating crosspoint arrays of dimensions larger than  $16 \times 16$ . Various features, such as output disable, chip enable, and gain-of-1 and gain-of-2 options, are useful for creating larger arrays. When required for customizing a crosspoint array size, they can be used with the [AD8108](#) and [AD8109](#), which are a pair of (unity-gain and gain-of-2)  $8 \times 8$  video crosspoint switches, or with the [AD8110](#) and [AD8111](#), a pair of (unity-gain and gain-of-2)  $16 \times 8$  video crosspoint switches.

The first consideration in constructing a larger crosspoint is to determine the minimum number of required devices that are required. The  $16 \times 16$  architecture of the [ADV3226/ADV3227](#) contains 256 points, which is a factor of 64 greater than a  $4 \times 1$  crosspoint (or multiplexer). The benefits realized in PCB area used, power consumption, and design effort are readily apparent when compared to using multiples of these smaller  $4 \times 1$  devices.

To obtain the minimum number of required points for a non-blocking crosspoint, multiply the number of inputs by the number of outputs. Nonblocking requires that the programming of a given input to one or more outputs does not restrict the availability of that input to be a source for any other outputs. Some nonblocking crosspoint architectures require more than this minimum. In addition, there are blocking architectures that can be constructed with fewer devices than this minimum. These systems have connectivity available on a statistical basis that is determined when designing the overall system.

The basic concept in constructing larger crosspoint arrays is to connect inputs in parallel in a horizontal direction and to wire-OR the outputs together in the vertical direction. The meaning of horizontal and vertical can best be understood by referring to Figure 65, which illustrates this concept for a  $32 \times 32$  crosspoint array that uses four [ADV3226](#) or [ADV3227](#) devices.

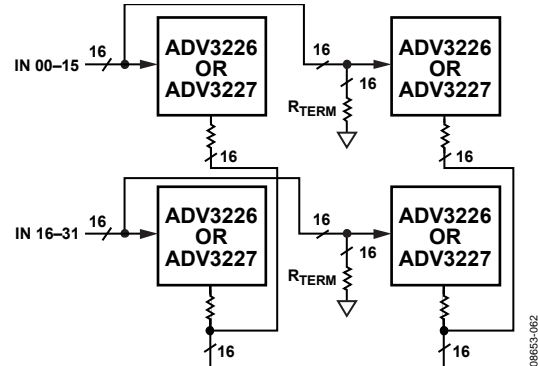
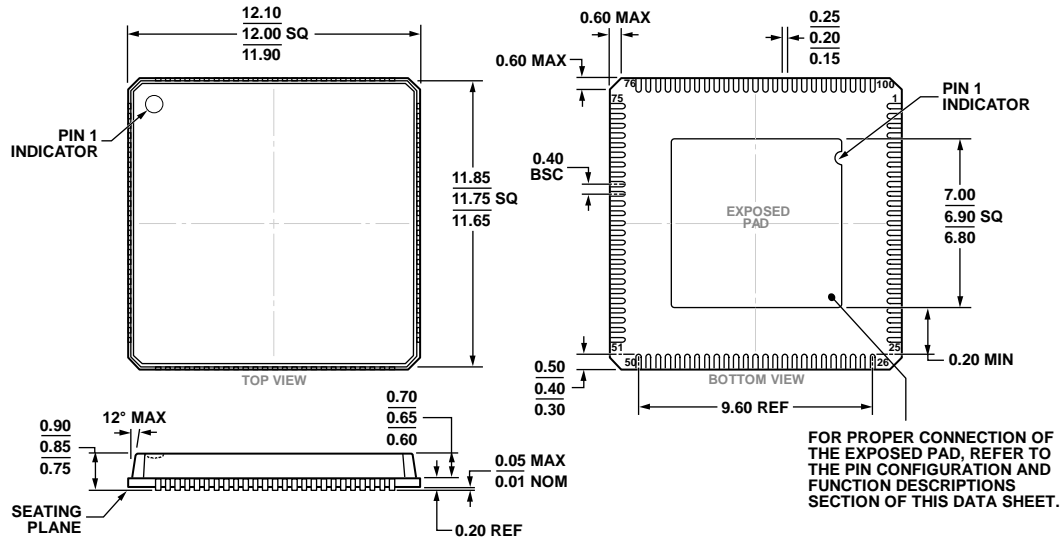

Figure 65. A  $32 \times 32$  Nonblocking Crosspoint Switch Array

Each input is uniquely assigned to each of the 32 inputs of the two devices and terminated appropriately. The outputs are wired-ORed together in pairs. Enable the output from only one wire-ORed pair at any given time. The device programming software must be properly written to prevent multiple connected outputs from being enabled at the same time.

For a complete  $32 \times 32$  array in a single device, refer to the [AD8117](#) and [AD8118](#) for high bandwidth or the [ADV3200](#) and [ADV3201](#) for lower bandwidth. Also available are  $32 \times 16$  arrays in a single package: [AD8104](#), [AD8105](#), [ADV3202](#), and [ADV3203](#).

OUTLINE DIMENSIONS



COMPLIANT TO JEDEC STANDARDS MO-220-VRRE.  
 Figure 66. 100-Lead Lead Frame Chip Scale Package [LFCSP\_VQ]  
 12 mm × 12 mm Body, Very Thin Quad  
 (CP-100-1)  
 Dimensions shown in millimeters

ORDERING GUIDE

Model <sup>1</sup>	Temperature Range	Package Description	Package Option
ADV3226ACPZ	-40°C to +85°C	100-Lead Lead Frame Chip Scale Package [LFCSP_VQ]	CP-100-1
ADV3227ACPZ	-40°C to +85°C	100-Lead Lead Frame Chip Scale Package [LFCSP_VQ]	CP-100-1
ADV3226-EVALZ		Evaluation Board	
ADV3227-EVALZ		Evaluation Board	

<sup>1</sup> Z = RoHS Compliant Part.