

Received	
<input checked="" type="checkbox"/>	MASS PRODUCTION
<input type="checkbox"/>	PRELIMINARY
<input type="checkbox"/>	CUSTOMER DESIGN
DEVICE NO. :	
PAGE : 12	

Revised record		
REV.	DESCRIPTION	RELEASE DATE

EAFL2016W16A0

MASS PRODUCTION

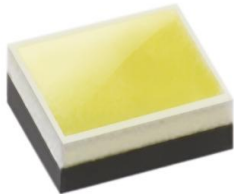

Features

- Small & compact package and with high efficiency
- Typical luminous flux: 160 lm @ 1000mA
- Typical color temperature: 5700 K@1000mA
- Optical efficiency@1A : 45 lm/W
- ESD protection up to 8KV
- Moisture Sensitivity Level (MSL) Class 1
- Grouping parameter: total luminous flux, color coordinates.
- RoHS compliant & Pb free.

Applications

- Mobile Phone Camera Flash(Camera flash light /strobe light for mobile devices)
- Torch light for DV(Digital Video) application
- Indoor lighting applications
- Signal and symbol luminaries for orientation marker lights (e.g. steps, exit ways, etc.)
- TFT backlighting
- Exterior and interior illumination applications
- Decorative and Entertainment Lighting
- Exterior and interior automotive illumination

Device Selection Guide

Chip Materials	Emitted Color
InGaN	White

Absolute Maximum Ratings ($T_{\text{solder pad}}=25^{\circ}\text{C}$)

Parameter	Symbol	Rating	Unit
DC Forward Current (mA)	I_F	350	mA
Peak Pulse Current (mA) (400ms : ON , 3600ms : OFF)	I_{pulse}	1500	mA
ESD Resistance	V_B	8000	V
Reverse Voltage	V_R	[1]	V
Junction Temperature	T_J	125	$^{\circ}\text{C}$
Thermal Resistance(junction to lead)	R_s	10	$^{\circ}\text{C}/\text{W}$
Operating Temperature	T_{opr}	-40 ~ +85	$^{\circ}\text{C}$
Storage Temperature	T_{stg}	-40 ~ +110	$^{\circ}\text{C}$
Power Dissipation (Pulse Mode)	P_d	6.5	W
Soldering Temperature	T_{sol}	260	$^{\circ}\text{C}$
Allowable Reflow Cycles	n/a	2	cycles
Viewing Angle ₍₂₎	$2\theta_{1/2}$	120	deg

Note:

- The EAFL2016W16A0 series LEDs are not designed for reverse bias used.
- View angle tolerance is $\pm 5^{\circ}$.
- Avoid operating EAFL2016W16A0 series LEDs at maximum operating temperature exceed 1 hour.
- All specification is assured by reliability test for 1000hr, IV degradation less than 30%.
- All reliability items are tested under good thermal management with 1.0x 1.0 cm² MCPCB.
- Peak pulse current shall be applied under conditions as max duration time 50ms and max duty cycle 10%.
- Operate LED component at maximum rating conditions continuously will cause possible permanent damage and de-rating parameters.
Exercise multiple maximum rating parameters simultaneously should not be allowed. When maximum rating parameters are applied over a long period will result potential reliability issue.

JEDEC Moisture Sensitivity

Level	Floor Life		Soak Requirements Standard	
	Time (hours)	Conditions	Time (hours)	Conditions
1	unlimited	≤30°C / 85% RH	168(+5/-0)	85°C / 85 RH

Electro-Optical Characteristics ($T_{\text{solder pad}} = 25^{\circ}\text{C}$)

Parameter	Symbol	Min.	Typ.	Max.	Unit	Condition
Luminous Flux ₍₁₎	Φ_v	140	160	----	lm	$I_F = 1000\text{mA}$
Forward Voltage ₍₂₎₍₃₎	V_F	2.95	----	4.35	V	
Correlated Color Temperature	CCT	4500	----	7000	K	

Note:

1. Luminous flux measurement tolerance: ±10%
2. Forward voltage measurement tolerance: ±0.1V
3. Electric and optical data is tested at 50 ms pulse condition

Bin Range of Forward Voltage Binning

Bin Code	Min.	Typ.	Max.	Unit	Condition
2932	2.95	----	3.25	V	$I_F = 1000\text{mA}$
3235	3.25	----	3.55		
3538	3.55	----	3.85		
3841	3.85	----	4.15		
4143	4.15	----	4.35		

Bin Range of Luminous Intensity

Bin Code	Min.	Typ.	Max.	Unit	Condition
J3	140	----	160	lm	$I_F = 1000\text{mA}$
J4	160	----	180		
J5	180	----	200		

White Bin Structure

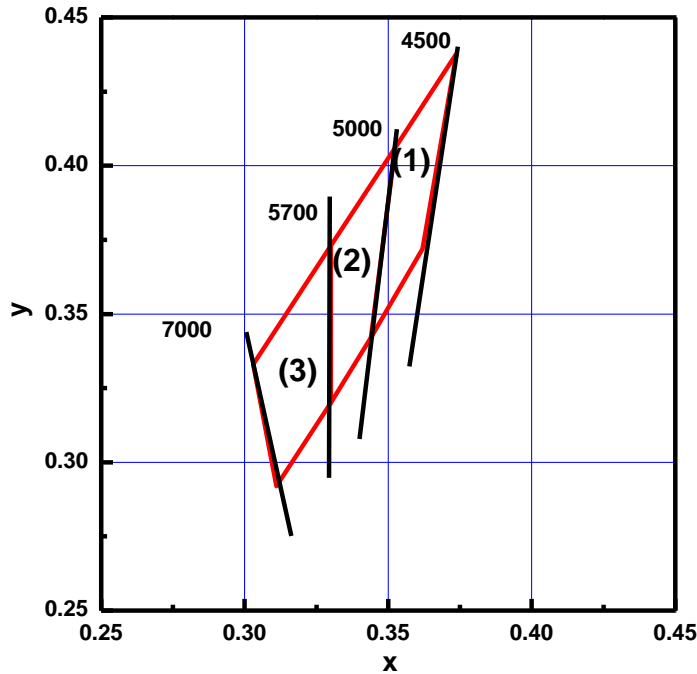

Notes :

1. Color Bin (1) : 4550K
2. Color Bin (2) : 5057K
3. Color Bin (3) : 5770K

White Bin Coordinate

Bin	CIE-X	CIE-Y	CCT Reference Range
4550	0.3738	0.4378	4500K ~ 5000K
	0.3524	0.4061	
	0.3440	0.3420	
	0.3620	0.3720	
5057	0.3300	0.3200	5000K ~ 5700K
	0.3300	0.3730	
	0.3440	0.3420	
	0.3524	0.4061	
5770	0.3030	0.3330	5700K ~ 7000K
	0.3300	0.3730	
	0.3300	0.3200	
	0.3110	0.2920	

Note:

1. Color coordinates measurement allowance: ± 0.01
2. Color bins are defined at $I_F = 1000\text{mA}$ and 50ms pulse operation condition.

Typical Electro-Optical Characteristics Curves

Relative Spectral Distribution, $I_F=1000\text{mA}$ @ 50ms , $T_{\text{solder pad}}=25^\circ\text{C}$

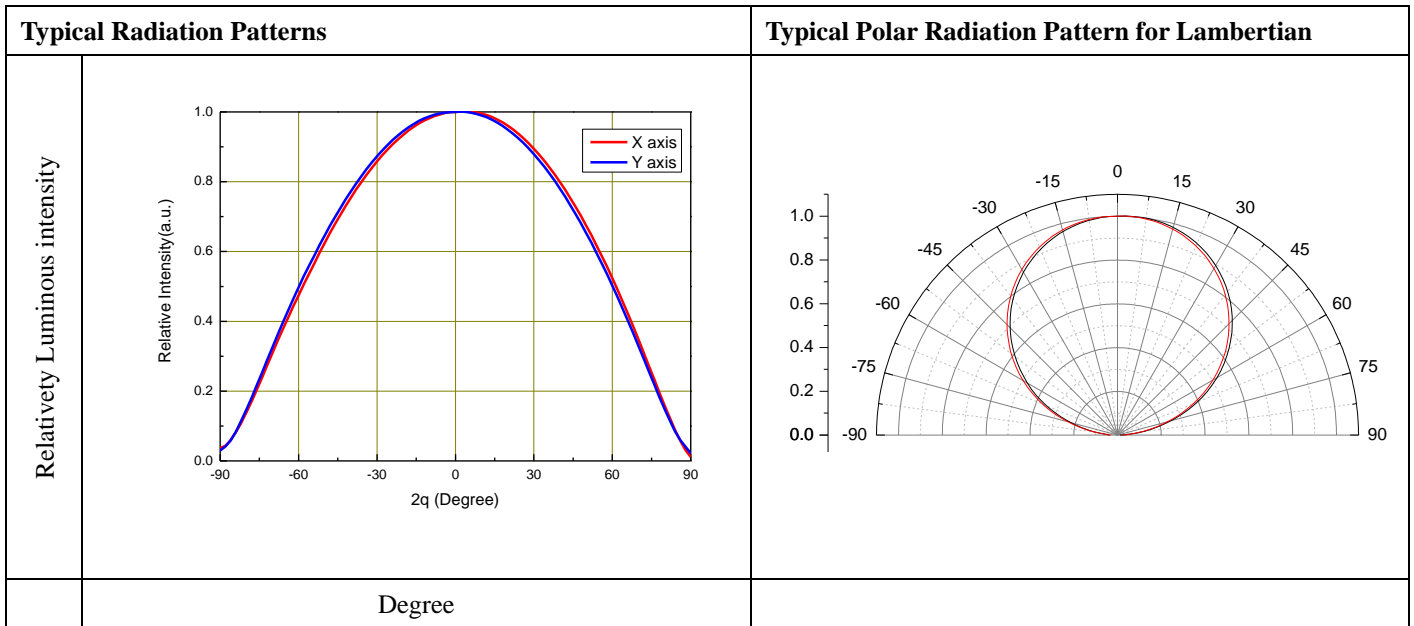
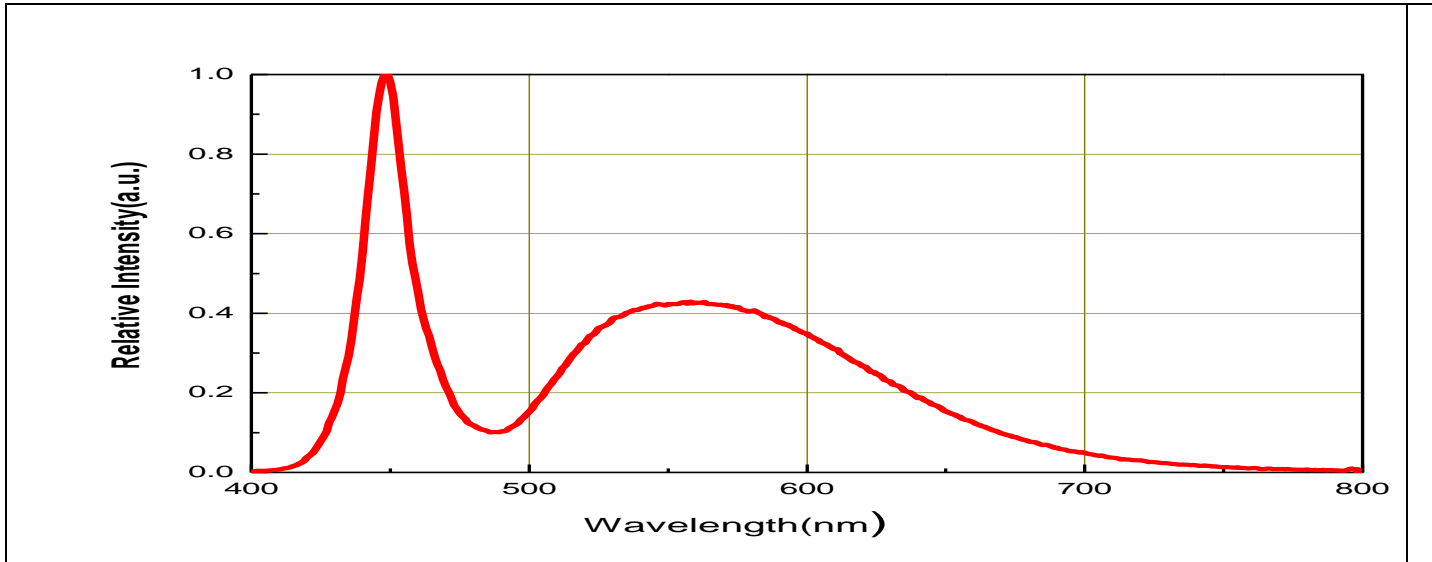

Note:

- $2\theta_{1/2}$ is the off axis angle from lamp centerline where the luminous intensity is 1/2 of the peak value.
- View angle tolerance is $\pm 5^\circ$.

Forward Voltage vs Forward Current,

$T_{\text{solder pad}} = 25^{\circ}\text{C}$

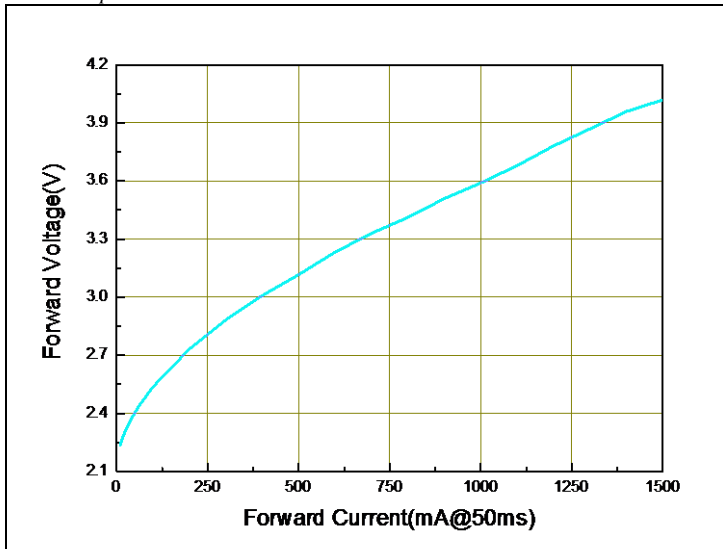

Correlated Color Temperature(CCT) vs. Forward Current

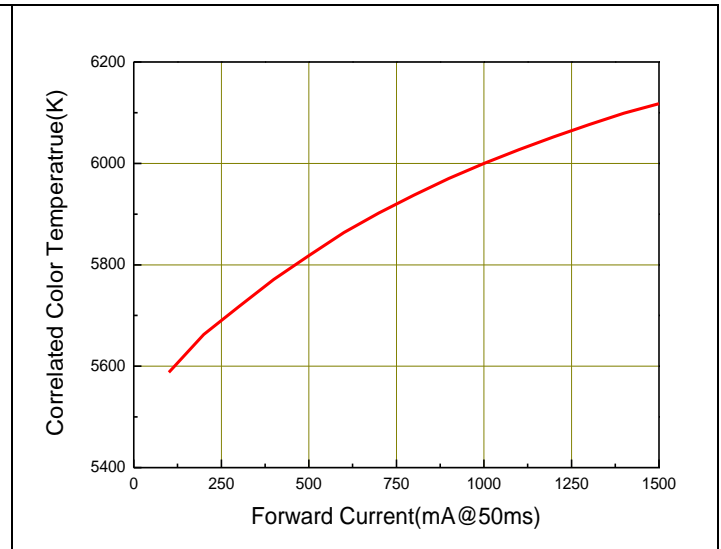

Luminous Flux vs Forward Current,

$T_{\text{solder pad}} = 25^{\circ}\text{C}$

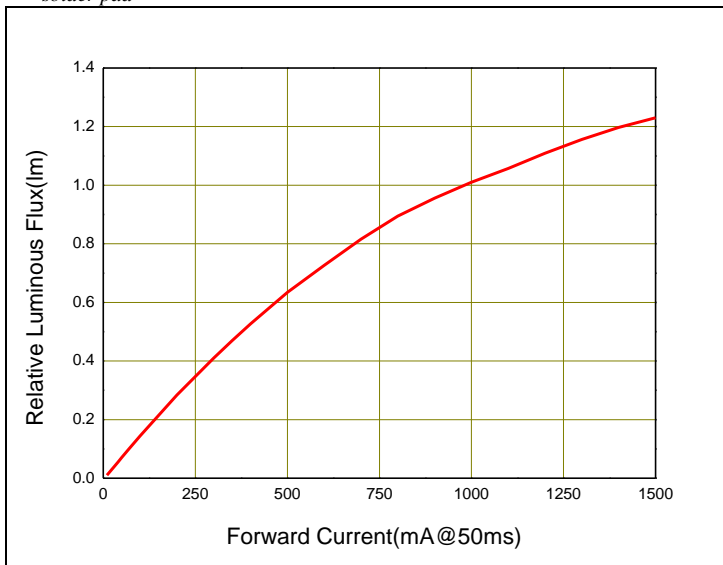

**Forward Current Derating Curve,
Derating based on $T_{j\text{MAX}} = 125^{\circ}\text{C}$ at torch mode**

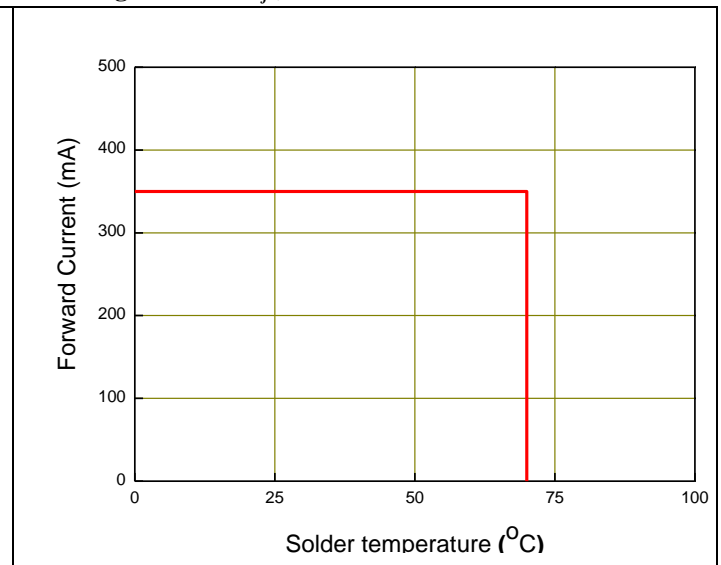

Note:

1. All correlation data is tested under superior thermal management with 1.0x 1.0 cm² MCPCB

Package Dimension

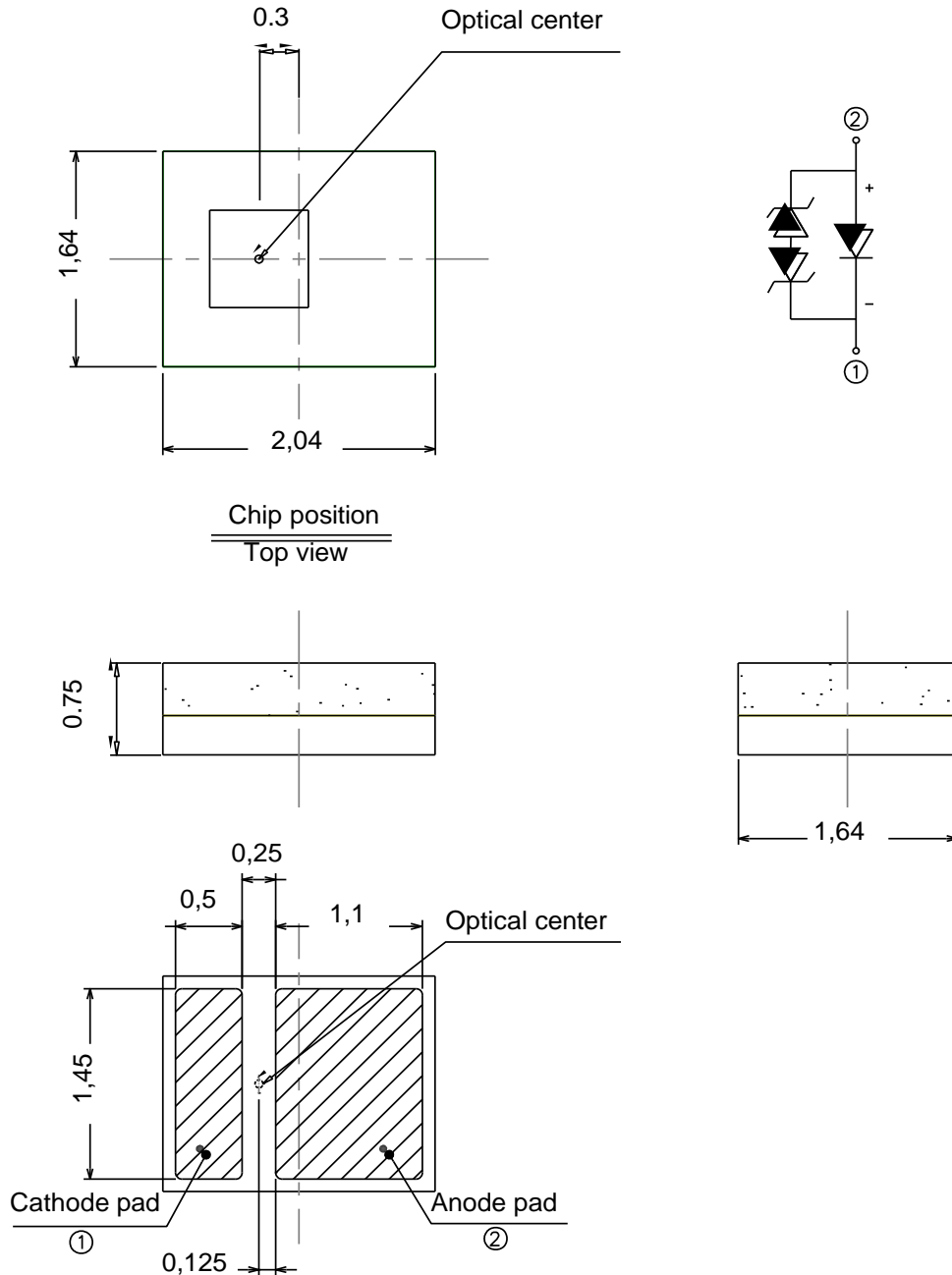

Note:

1. Dimensions are in millimeters.
2. Tolerances unless mentioned are ± 0.1 mm.

Moisture Resistant Packing Materials

Label Explanation



- CPN: Customer Specification (when required)
- P/N: Everlight Americas Production Number
- QTY: Packing Quantity
- CAT: Luminous Flux (Brightness) Bin
- HUE: Color Bin
- REF: Forward Voltage Bin
- LOT No: Lot Number

Carrier Tape Dimensions: Loaded Quantity 2000 pcs Per Reel

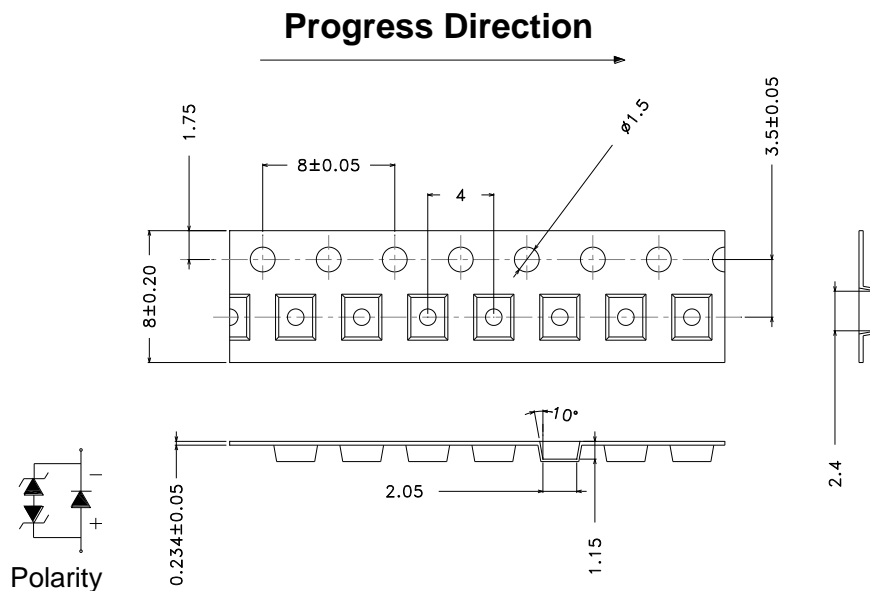

Note:

1. Dimensions are in millimeters.
2. Tolerances unless mentioned are ± 0.1 mm.

Reel Dimensions

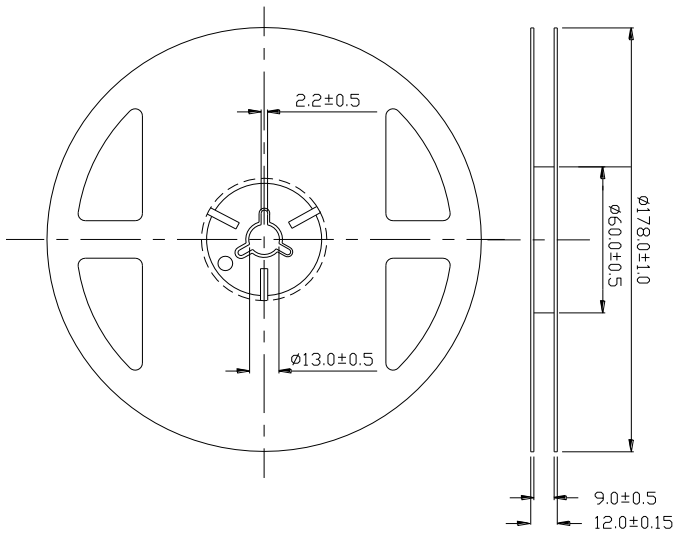

Note:

1. Dimensions are in millimeters.

Moisture Resistant Packing Process

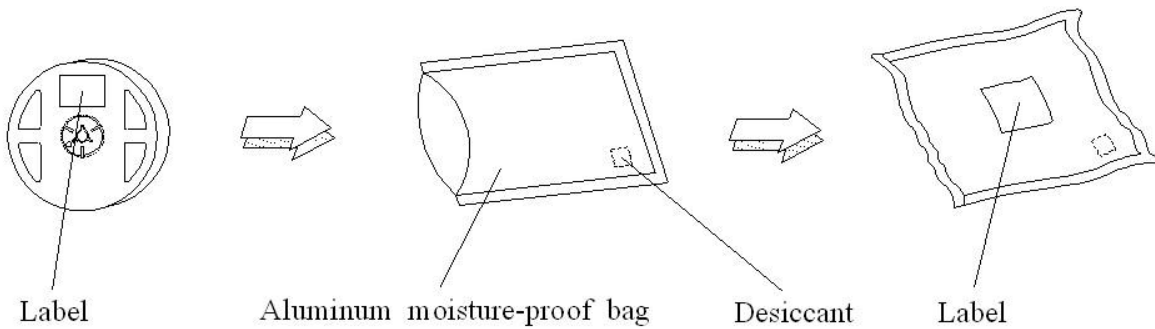

Reflow Soldering Characteristics

Soldering and Handling

1. Over-current-proof

Though EAFL2016W16A0 series has conducted ESD protection mechanism, customers must not use the device in reverse and should apply resistors

for extra protection. Otherwise, slight voltage shift may cause enormous current shift and burn out failure would happen.

2. Storage

- i. Do not open the moisture-proof bag before the products are ready to use.
- ii. Before opening the package, the LEDs should be stored at temperature less than 30°C and less and relative humidity less than 90%.
After opening the package, the LEDs should be stored at temperature less than 30°C and relative humidity less than 85%.
- iii. If the moisture absorbent material (silicone gel) has faded away or the LEDs have exceeded the storage time, baking treatment should be implemented based on the following conditions: Pre-curing at 60±5°C for 24 hours.

3. Thermal Management

- i. For maintaining the high flux output and achieving reliability, EAFL2016W16A0 series LEDs should be mounted on a metal core printed circuit board (MCPCB), with proper thermal connection to dissipate approximately 1W to 5W of thermal energy under normal operation.
- ii. Sufficient thermal management must be conducted, or the die junction temperature will be over the limit under large electronic driving and LEDs lifetime will decrease critically
- iii. When operating , the solder pad temperature (or the board temperature nearby the LED) must controlled under 70°C .

4. Soldering Condition

4.1 Soldering Pad

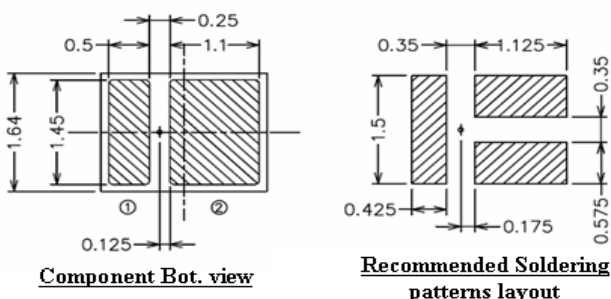

4.2 For Reflow Process

i. Lead reflow soldering temperature profile

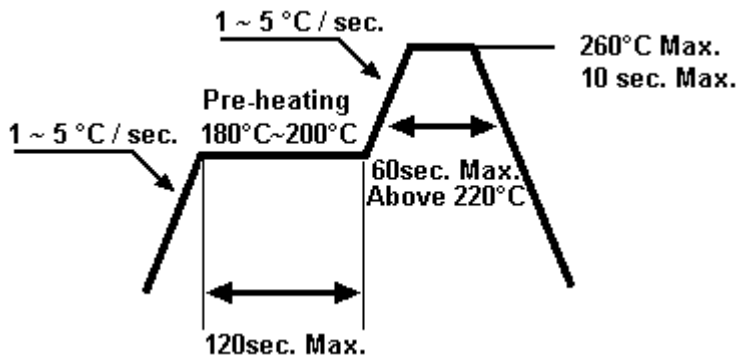

- i. Reflow soldering should not be done more than two times.
- ii. While soldering, do not put stress on the LEDs during heating.
- iii. After soldering, do not warp the circuit board.