

LOC	DIST	REV	DATE	BY	CHK	APPD
AD	00					
6		ADDED NOTES FOR TORQUE	30 JUN 2009	HL		SY
7		ADDED NEW DASHNUMBER -3 AND -4	22 JUL 2009	HL		SY
8		REVISED DRAWING	23 JUL 2009	HL		SY
A		REV PER ECR-09-016443	23 JUL 2009	HL		SY

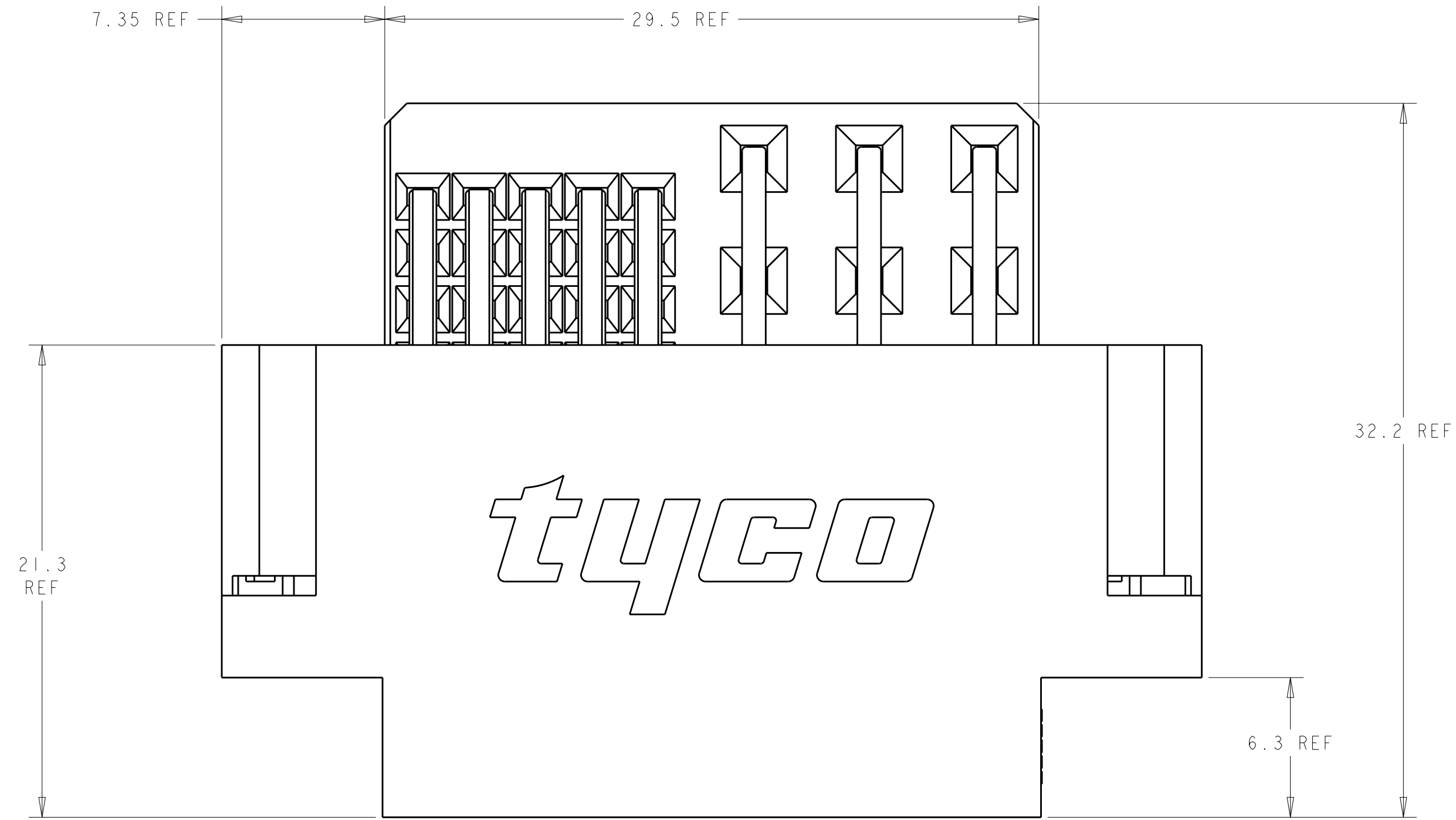

- 1 MATERIAL: HOUSING & SPACER - THERMOPLASTIC; COLOR - BLACK
 SIGNAL CONTACT - PHOSPHORUS BRONZE
 POWER CONTACT - COPPER ALLOY
 THREADED INSERT - ZINC
- 2 PLATING: SIGNAL CONTACT - 1.27um MIN NICKEL OVER ALL
 1 um MIN MATTE TIN ON CONTACT AREA
 0.76 um MIN GOLD ON INTERFACE AREA
 POWER CONTACT - 1.27um MIN NICKEL OVER ALL
 1 um MIN MATTE TIN ON CONTACT AREA
 0.76 um MIN GOLD ON INTERFACE AREA
 THREADED INSERT - CLEAR CHROMATE
- 3 PCB - ALL HOLE DIAMETERS FINISHED HOLE SIZES
- 4 DATUMS AND BASIC DIMENSIONS ESTABLISHED BY CUSTOMER
- 5 DIMENSION APPLIES TO CENTERLINE OF THRU HOLE
- 6 OPTIONAL - NEEDED FOR USE WITH BOARD LOCKS
- 7 FOR 6469602-3 AND -4 THE RECOMMENDED TORQUE FOR THE STANDOFF NUT IS 1.02 N-m (9.00 in-lbs) MAX
- 8 FOR 6469602-3 AND -4 PLEASE REFER TO SHEET 2.
- 9 FOR 6469602-1 AND -2 THE DIMENSION D IS 3.5 mm.
 FOR 6469602-3 AND -4 THE DIMENSION D IS 4.5 mm.

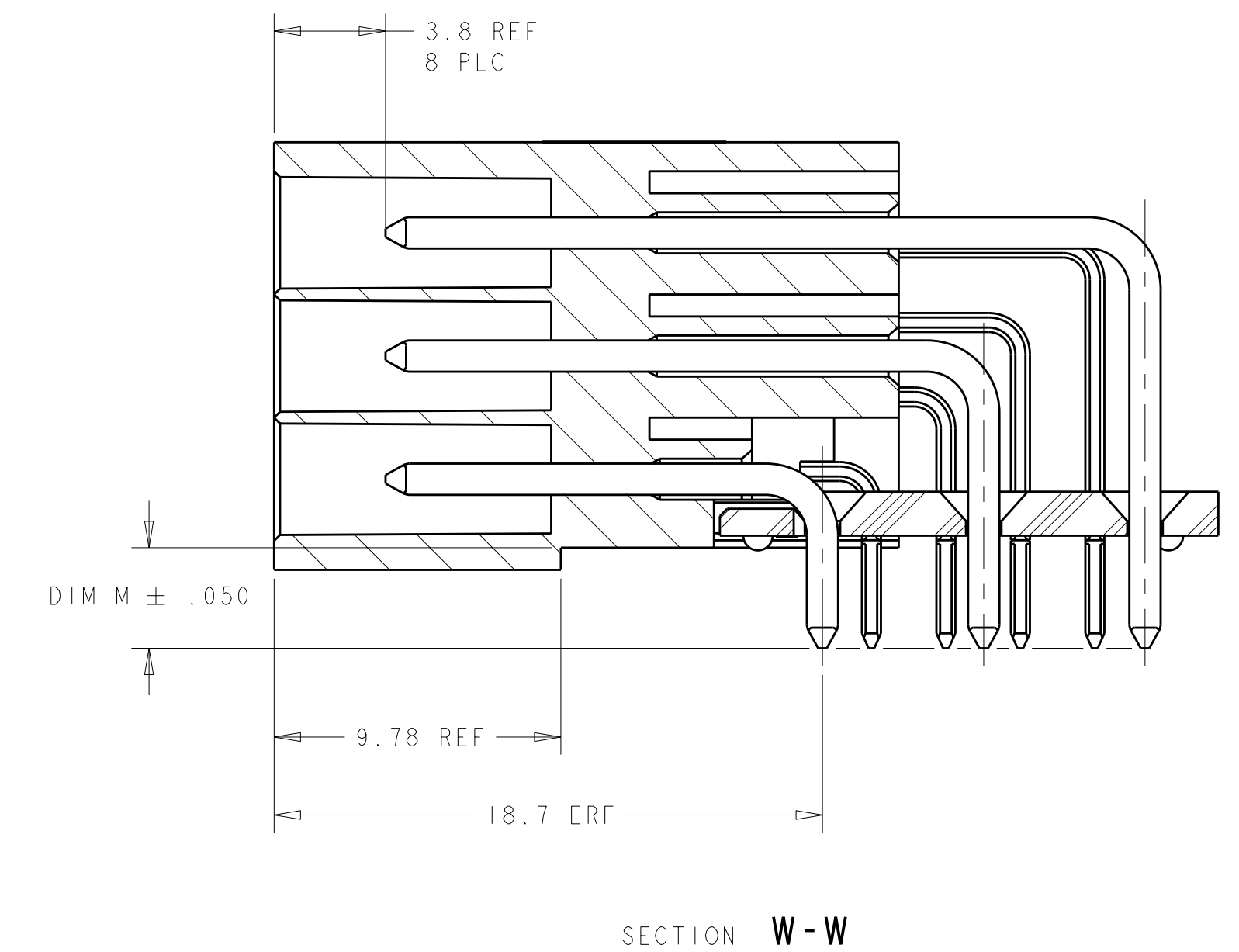
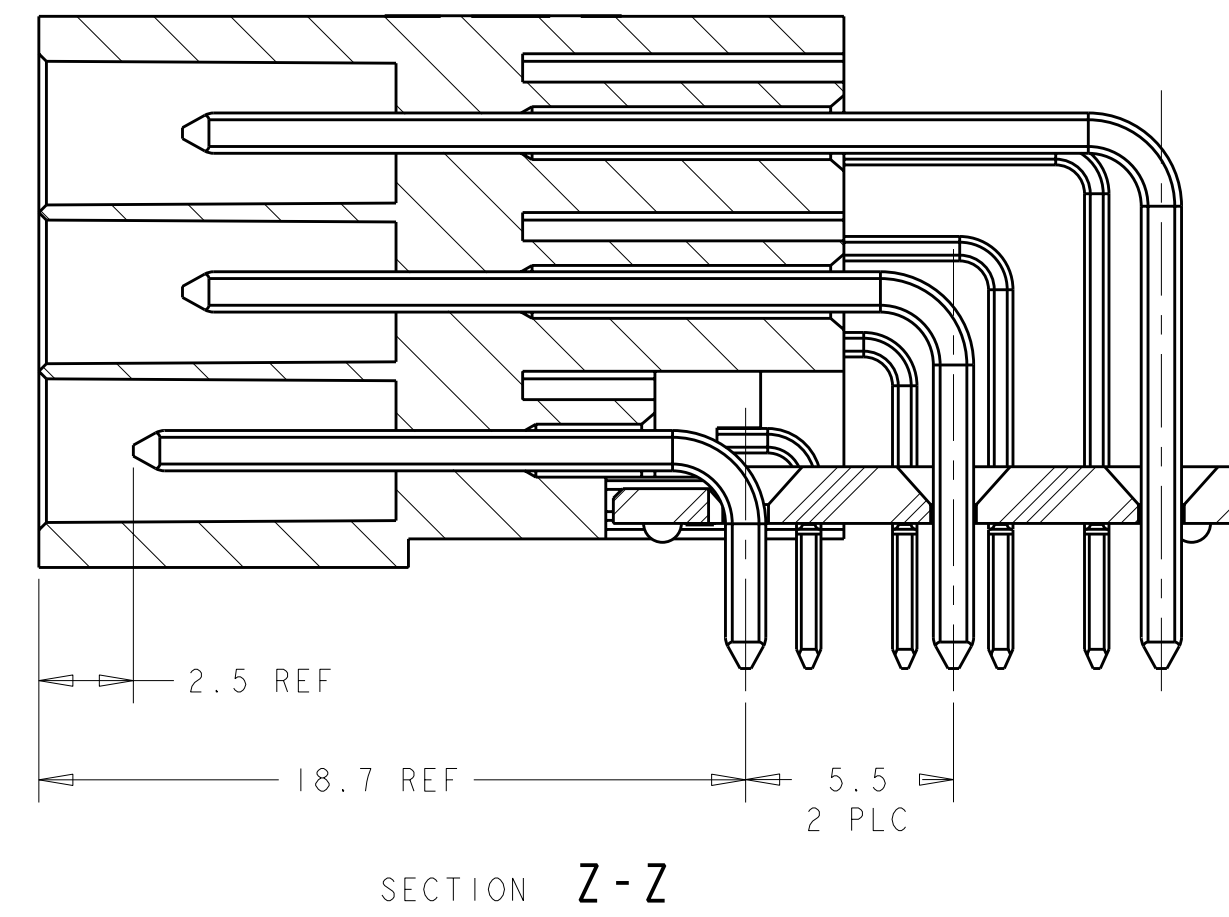
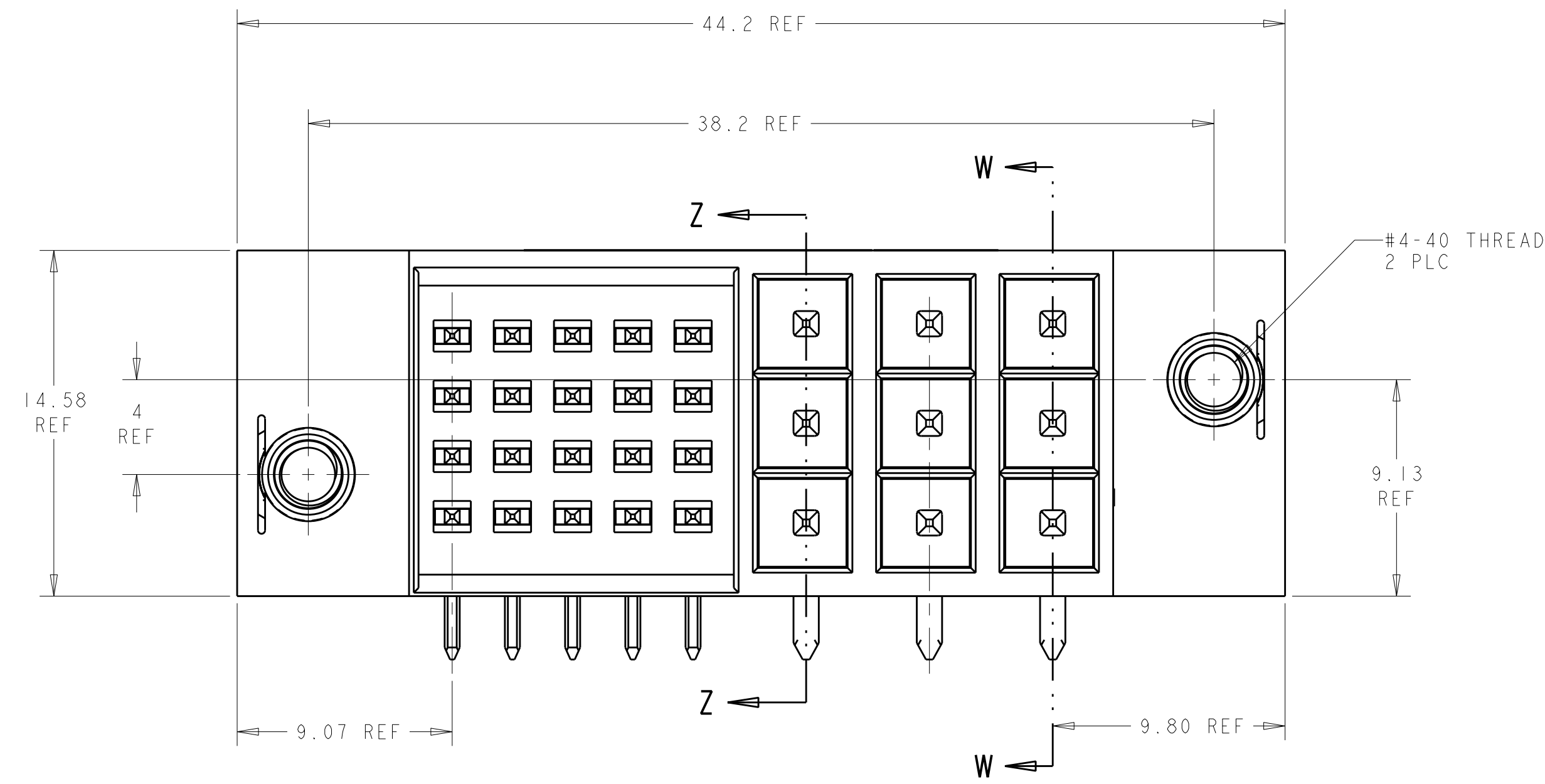

6.86	6469602-2
3.43	6469602-1
DIM M	PART NUMBER

<small>THIS DRAWING IS UNPUBLISHED. RELEASED FOR PUBLICATION BY TYCO ELECTRONICS CORPORATION. ALL RIGHTS RESERVED.</small>		DWN: S. J. MAGARO 31 JAN 2006 CHK: C. RITIER 31 JAN 2006 APVD:	Tyco Electronics Corporation Harrisburg, PA 17105-3608
DIMENSIONS: mm TOLERANCES UNLESS OTHERWISE SPECIFIED: 9 PLC ± 1 PLC ± 2 PLC ± 3 PLC ± 4 PLC ± ANGLES ± FINISH		PRODUCT SPEC APPLICATION SPEC WEIGHT CUSTOMER DRAWING	NAME: DUAC PL - II, HEADER ASSEMBLY SIZE: A 00779 C=6469602 SCALE: 5:1 SHEET 1 OF 3 REV A

LOC	DIST	REVISIONS			
P	LTR	DESCRIPTION	DATE	DWN	APVD
AD	00	SEE SHEET 1	-	-	-

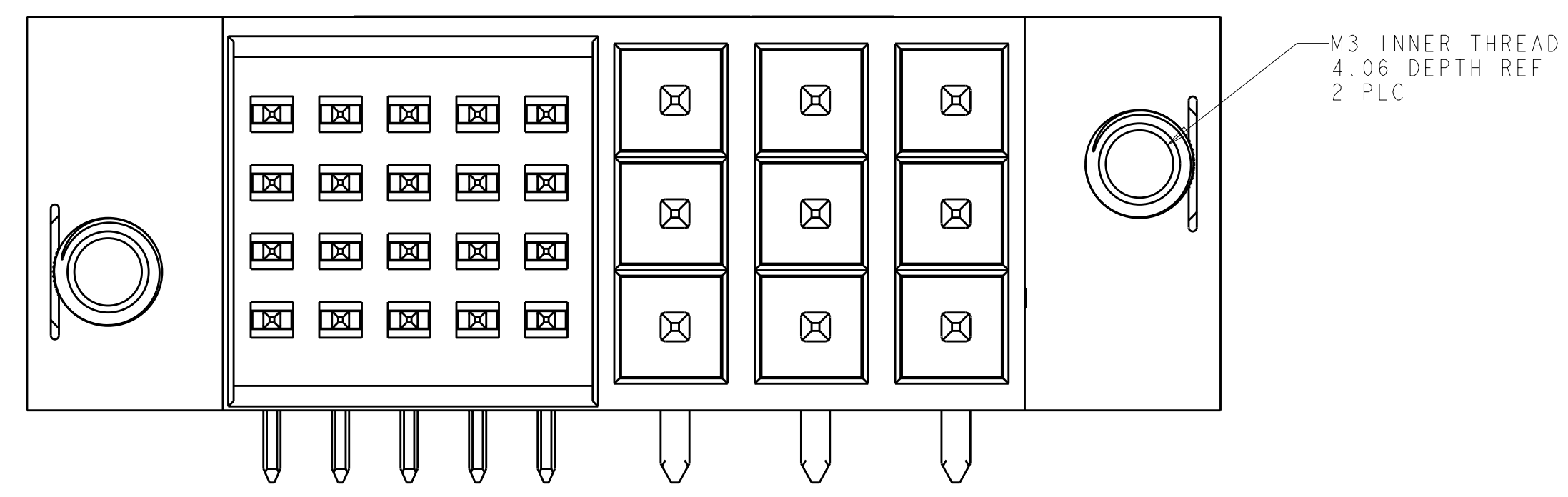
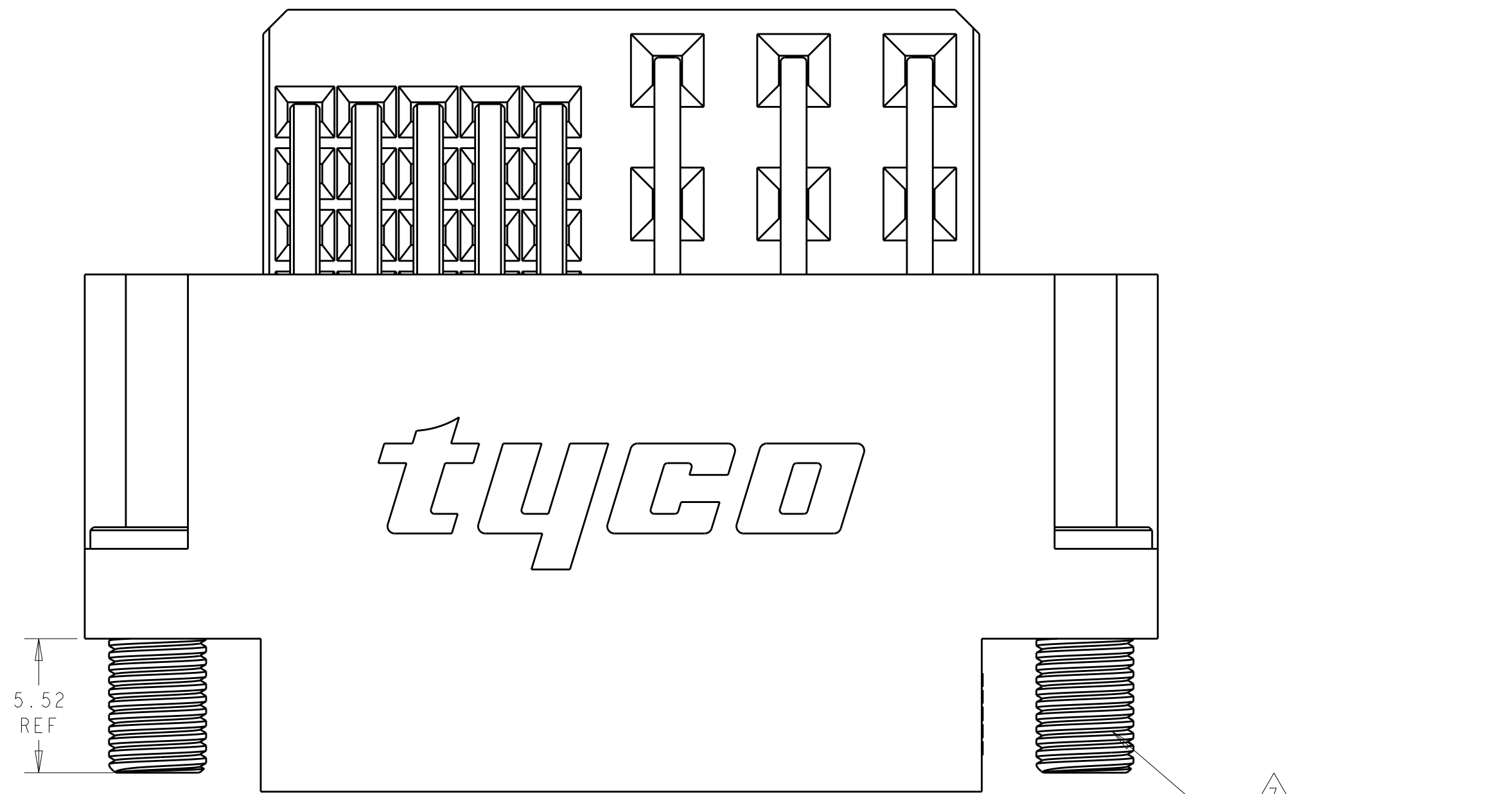

6469602-3 AND 6469602-4
 UNSPECIFIED DIMENSIONS PLEASE REFER TO SHEET 1.

6.86	6469602-4
3.43	6469602-3
DIM M	PART NUMBER

<small>THIS DRAWING IS UNPUBLISHED. IT IS SUBJECT TO CHANGE WITHOUT NOTICE AND WITHOUT OBLIGATION. SHOULD BE CONTACTED FOR THE LATEST REVISION.</small>		DWN S. J. MAGARO 31JAN2006 CHK C. RITIER 31JAN2006 APVD -	Tyco Electronics Corporation Harrisburg, PA 17105-3608
DIMENSIONS: mm 		TOLERANCES UNLESS OTHERWISE SPECIFIED: 9 PLC ± 1 PLC ± 2 PLC ± 3 PLC ± 4 PLC ± ANGLES ±	NAME DUAC PL - 11, HEADER ASSEMBLY PRODUCT SPEC - APPLICATION SPEC - SIZE CAGE CODE DRAWING NO. RESTRICTED TO A 100779 C=6469602 -
MATERIAL - FINISH -		WEIGHT - CUSTOMER DRAWING	SCALE 5:1 SHEET 2 OF 3 REV A

LOC	DIST	REV	DATE	BY	APPD
AD	00				

REVISIONS		DATE	BY	APPD
-	SEE SHEET 1	-	-	-

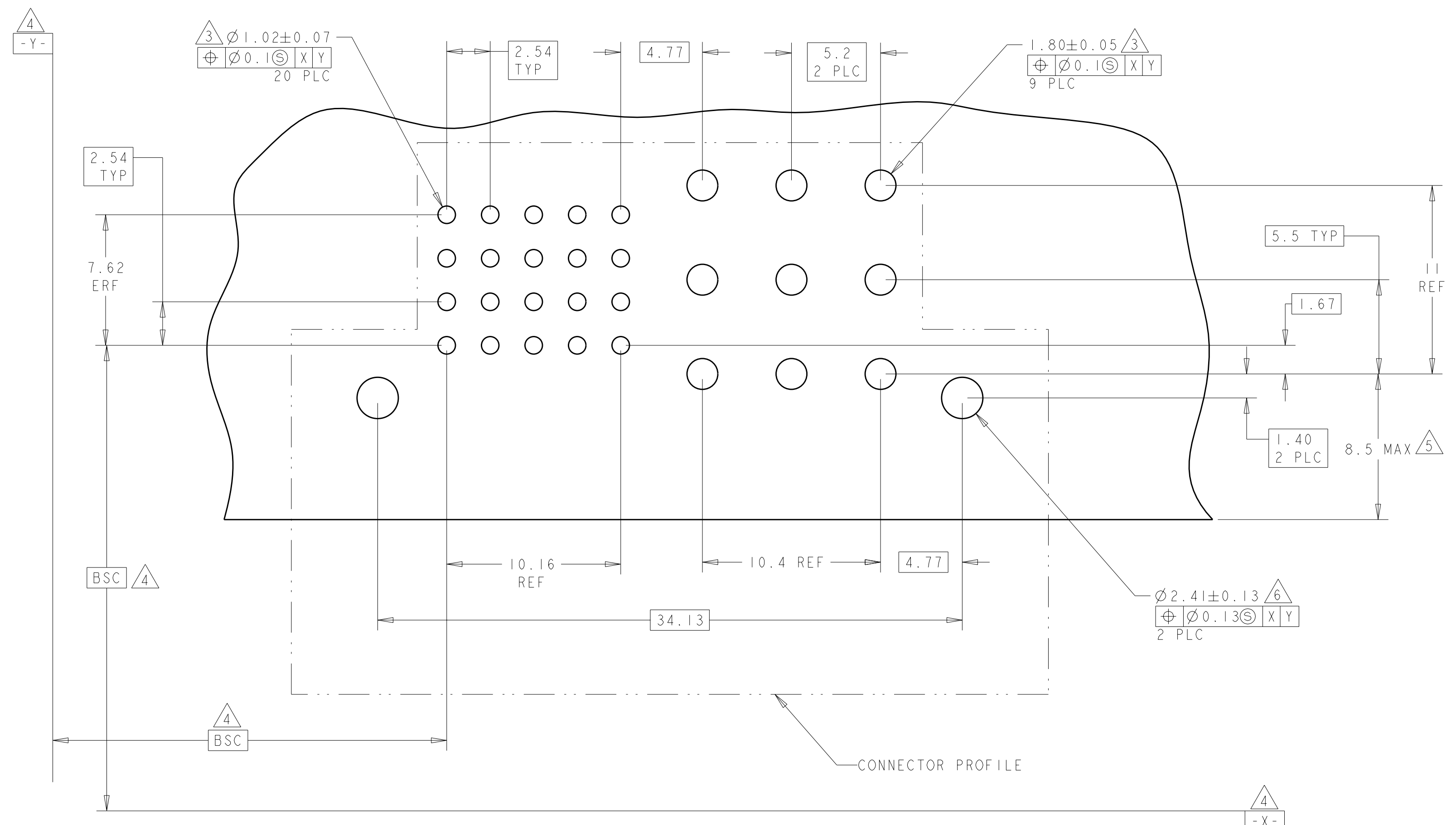

PCB SHOWN FROM COMPONENT SIDE OF BOARD
 SCALE 5:1

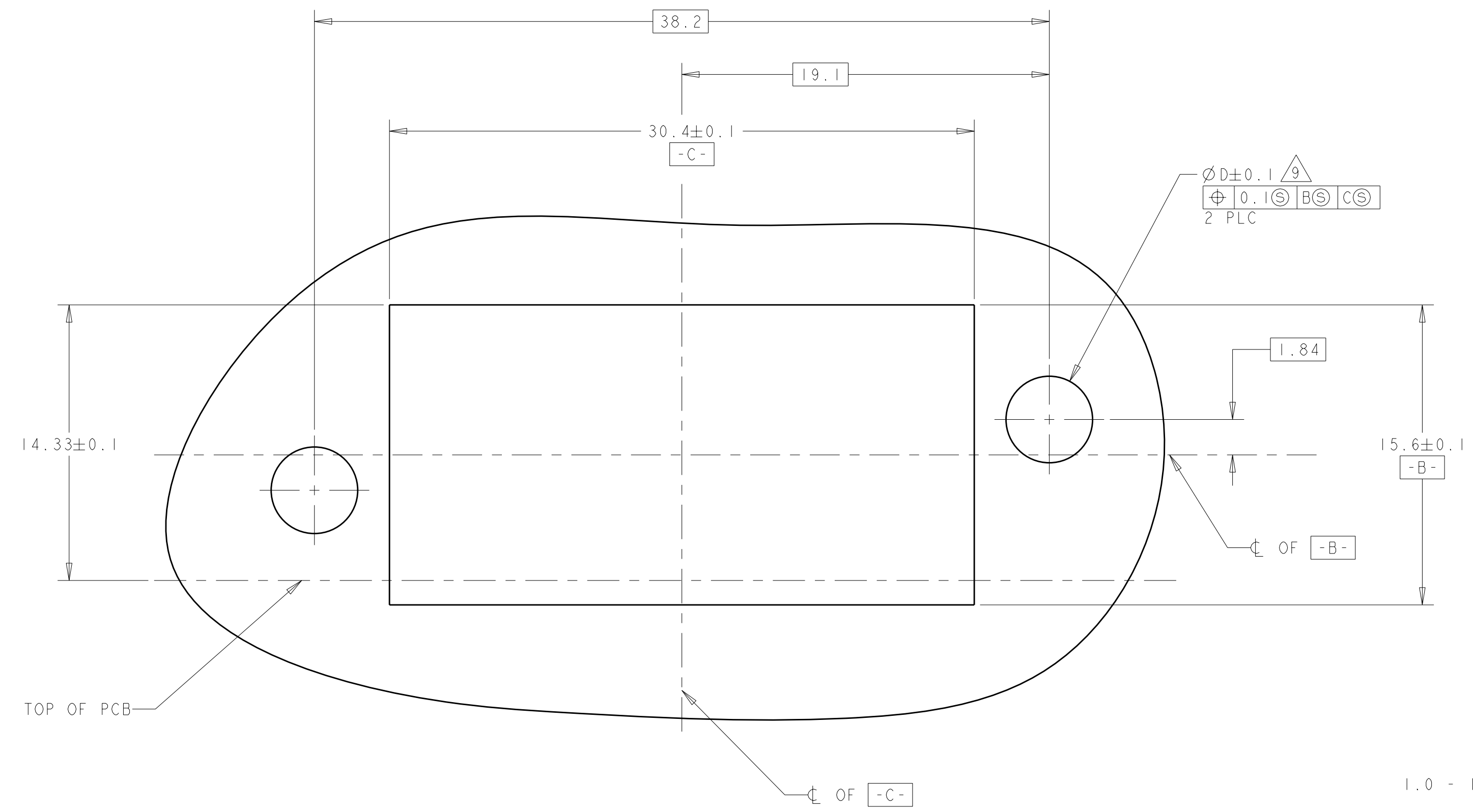

PANEL CUT-OUT
 SCALE 5:1

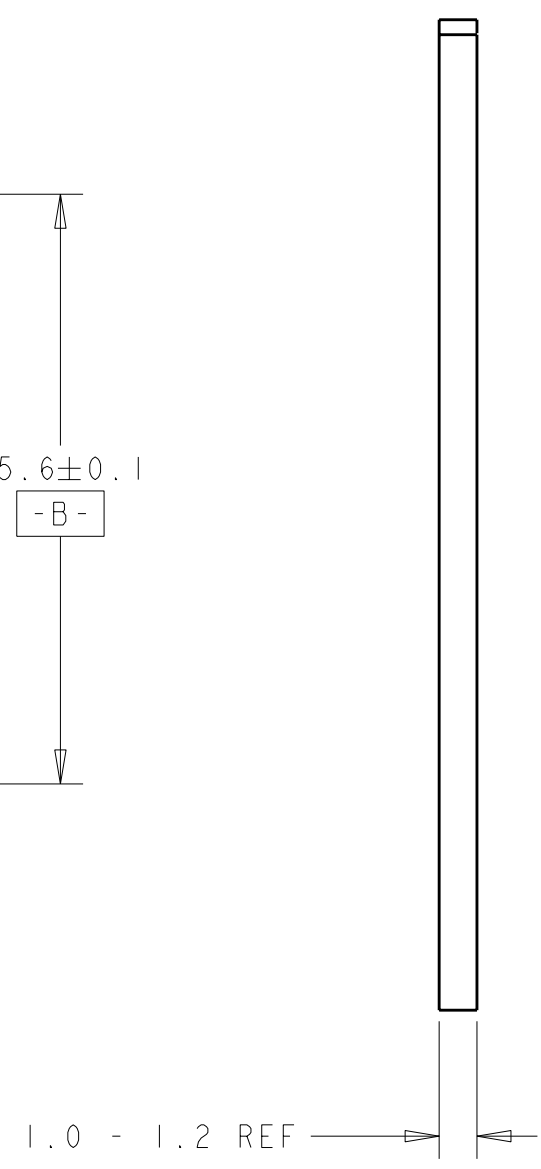

DIMENSIONS: mm 		TOLERANCES UNLESS OTHERWISE SPECIFIED: 9 PLC ± 1 PLC ± 2 PLC ± 3 PLC ± 4 PLC ± ANGLES ± FINISH ±		DWN S.J. MAGARO 31JAN2006 CHK C. RITTER 31JAN2006 APVD - NAME - PRODUCT SPEC - APPLICATION SPEC - WEIGHT - CUSTOMER DRAWING	Tyco Electronics Corporation Harrisburg, PA 17105-3608 DUAC PL - 11, HEADER ASSEMBLY SIZE CAGE CODE DRAWING NO RESTRICTED TO A100779C-6469602 SCALE 5:1 SHEET 3 OF 3 REV A
-----------------------	--	---	--	--	---