

VDR Metal Oxide Varistors High Surge



FEATURES

- Low β high purity zinc oxide disc
- Halogen free insulating epoxy coating
- Straight or kinked leads
- Higher current surge/size ratio capability up to 10 kA for H20 types
- Certified according to UL 1449 edition 3, VDE/IEC 61051-1/2 and CSA
- Material categorization: for definitions of compliance please see www.vishay.com/doc?99912



RoHS
COMPLIANT
HALOGEN
FREE

APPLICATION

- Overvoltage and transient voltage protection

DESCRIPTION

The varistors consist of a disc of low- β ceramic material with two solid copper leads (H20 types only) or copper clad steel wire. The wires have a matte tin plating. They are coated with a layer of ochre colored halogen-free epoxy, which provides electrical, mechanical and climatic protection. The encapsulation is resistant to all cleaning solvents in accordance with IEC 60068-2-45.

MOUNTING

The varistors are suitable for processing on automatic insertion, cutting and bending equipment.

Typical Soldering

- 235 °C, duration: 5 s (Pb-bearing)
- 245 °C, duration: 5 s (lead (Pb)-free)

Resistance to Soldering Heat

260 °C; duration: 10 s max.

MARKING

The varistors are marked with the following information:

- Maximum continuous RMS voltage with - E suffix
- Series number (582, 583, 584, 585 or 586)
- Manufacture logo
- Date of manufacture (YYWW)
- Safety marks on VDRH10-14-20 types

INFLAMMABILITY

The varistors are passive non-flammable. The encapsulation is made of flame resistant epoxy in accordance with UL 94 V-0.

QUICK REFERENCE DATA		
PARAMETER	VALUE	UNIT
Maximum continuous voltage in operating temperature range:		
RMS	11 to 680	V
DC	14 to 895	V
Maximum non-repetitive transient current I_{NRP} (8 x 20 μ s)	250 to 10 000	A
Maximum energy (10/1000 μ s)	0.7 to 620	J
Detailed specification	Based on IEC 61051-1 IEC 61051-2 IEC 61051-2-2	
Storage temperature	-40 to +150	°C
Operating temperature	-40 to +125	°C

ORDERING INFORMATION

The varistors are available in a number of packaging options:

- Bulk
- On tape on reel
- On tape in ammpack

The basic ordering code for each option is given in tables titled Varistors on Tape on Reel, Varistors on Tape in Ammpack, and Varistors in Bulk. To complete the catalog number and to determine the required operating parameters, see Electrical Data and Ordering Information table.

Note

- Special lead-configuration as inside or outside crimped leads on request.



ELECTRICAL DATA AND ORDERING INFORMATION											
MAXIMUM CONTINUOUS VOLTAGE		VOLTAGE ⁽³⁾ at 1 mA	MAXIMUM VOLTAGE at STATED CURRENT		MAXIMUM ENERGY ⁽⁴⁾ (10 x 1000 µs)	MAXIMUM NON-REP. TRANSIENT CURRENT ⁽⁵⁾ I _{NRP} (8 x 20 µs)	TYPICAL CAPACITANCE at 1 kHz	T (max.)	E	UL 1449 ED3 SPD TYPE ⁽⁷⁾	CATALOG NUMBERS ⁽¹⁾
RMS ⁽²⁾ (V)	DC (V)	(V)	V (V)	I (A)	(J)	(A)	(pF)	(mm)	(mm)		SAP ⁽⁶⁾
11	14	18	40	1.0	0.7	250	1600	3.4	0.5 ± 0.3	4	VDRH05B011xyE
			36	2.5	1.5	500	3600	3.4	0.5 ± 0.3	4	VDRH07D011xyE
			36	5.0	2.6	1000	8000	3.8	0.7 ± 0.3	4	VDRH10G011xyE
			36	10.0	5.2	2000	20 000	3.8	0.7 ± 0.3	4	VDRH14M011xyE
14	18	22	48	1.0	0.8	250	1300	3.4	0.7 ± 0.3	4	VDRH05B014xyE
			43	2.5	1.7	500	2800	3.4	0.7 ± 0.3	4	VDRH07D014xyE
			43	5.0	3.2	1000	6000	3.8	0.9 ± 0.3	4	VDRH10G014xyE
			43	10.0	6.3	2000	15 000	3.8	0.9 ± 0.3	4	VDRH14M014xyE
			43	20.0	16.0	3000	30 000	4.2	1.1 ± 0.3	3	VDRH20R014ByE
17	22	27	60	1.0	1.1	250	1050	3.7	0.8 ± 0.3	4	VDRH05B017xyE
			53	2.5	2.1	500	2000	3.7	0.8 ± 0.3	4	VDRH07D017xyE
			53	5.0	3.9	1000	4000	4.1	1.0 ± 0.3	4	VDRH10G017xyE
			53	10.0	7.8	2000	10 000	4.1	1.0 ± 0.3	4	VDRH14M017xyE
			53	20.0	19.0	3000	20 000	4.5	1.2 ± 0.3	3	VDRH20R017ByE
20	26	33	73	1.0	1.3	250	900	3.9	1.0 ± 0.3	4	VDRH05B020xyE
			65	2.5	2.8	500	1500	3.9	1.0 ± 0.3	4	VDRH07D020xyE
			65	5.0	4.8	1000	3000	4.3	1.2 ± 0.3	4	VDRH10G020xyE
			65	10.0	9.5	2000	7500	4.3	1.2 ± 0.3	4	VDRH14M020xyE
			65	20.0	24.0	3000	15 000	4.7	1.4 ± 0.3	3	VDRH20R020ByE
25	31	39	86	1.0	1.5	250	500	4.2	1.2 ± 0.3	4	VDRH05B025xyE
			77	2.5	3.0	500	1350	4.2	1.2 ± 0.3	4	VDRH07D025xyE
			77	5.0	5.6	1000	2600	4.6	1.4 ± 0.3	4	VDRH10G025xyE
			77	10.0	11.0	2000	6500	4.6	1.4 ± 0.3	4	VDRH14M025xyE
			77	20.0	28.0	3000	13 000	5.0	1.6 ± 0.3	3	VDRH20R025ByE
30	38	47	104	1.0	1.8	250	700	4.4	1.4 ± 0.5	4	VDRH05B030xyE
			93	2.5	3.8	500	1600	4.4	1.4 ± 0.5	4	VDRH07D030xyE
			93	5.0	6.8	1000	2700	4.8	1.6 ± 0.5	4	VDRH10G030xyE
			93	10.0	14.0	2000	6000	4.8	1.6 ± 0.5	4	VDRH14M030xyE
			93	20.0	34.0	3000	12 000	5.2	1.8 ± 0.5	3	VDRH20R030ByE
35	45	56	123	1.0	2.2	250	560	4.8	1.7 ± 0.5	4	VDRH05B035xyE
			110	2.5	4.4	500	1300	4.8	1.7 ± 0.5	4	VDRH07D035xyE
			110	5.0	8.1	1000	2200	5.2	1.9 ± 0.5	4	VDRH10G035xyE
			110	10.0	16.0	2000	4800	5.2	1.9 ± 0.5	4	VDRH14M035xyE
			110	20.0	41.0	3000	9600	5.6	2.1 ± 0.5	3	VDRH20R035ByE
40	56	68	150	1.0	2.6	250	460	5.1	2.1 ± 0.5	4	VDRH05B040xyE
			135	2.5	5.4	500	1000	5.1	2.1 ± 0.5	4	VDRH07D040xyE
			135	5.0	9.8	1000	1800	5.5	2.3 ± 0.5	4	VDRH10G040xyE
			135	10.0	20.0	2000	3800	5.5	2.3 ± 0.5	4	VDRH14M040xyE
			135	20.0	49.0	3000	7600	5.9	2.5 ± 0.5	3	VDRH20R040ByE
50	65	82	145	5.0	3.5	800	370	3.5	0.6 ± 0.3	4	VDRH05E050xyE
			135	10.0	7.0	1750	900	3.5	0.6 ± 0.3	4	VDRH07K050xyE
			135	25.0	14.0	3500	1500	3.9	0.8 ± 0.3	3	VDRH10S050xyE
			135	50.0	28.0	6000	3100	3.9	0.8 ± 0.3	2	VDRH14V050xyE



ELECTRICAL DATA AND ORDERING INFORMATION											
MAXIMUM CONTINUOUS VOLTAGE		VOLTAGE ⁽³⁾ at 1 mA	MAXIMUM VOLTAGE at STATED CURRENT		MAXIMUM ENERGY ⁽⁴⁾ (10 x 1000 µs)	MAXIMUM NON-REP. TRANSIENT CURRENT ⁽⁵⁾ I _{NRP} (8 x 20 µs)	TYPICAL CAPACITANCE at 1 kHz	T (max.)	E	UL 1449 ED3 SPD TYPE ⁽⁷⁾	CATALOG NUMBERS ⁽¹⁾
RMS ⁽²⁾ (V)	DC (V)	(V)	V (V)	I (A)	(J)	(A)	(pF)	(mm)	(mm)		SAP ⁽⁶⁾
60	85	100	175	5.0	4.5	800	290	3.7	0.7 ± 0.3	4	VDRH05E060xyE
			165	10.0	9.0	1750	700	3.7	0.7 ± 0.3	4	VDRH07K060xyE
			165	25.0	18.0	3500	1200	4.1	0.9 ± 0.3	4	VDRH10S060xyE
			165	50.0	36.0	6000	2300	4.1	0.9 ± 0.3	2	VDRH14V060xyE
			165	100.0	72.0	10 000	4600	4.5	1.1 ± 0.3	2	VDRH20X060ByE
75	100	120	210	5.0	5.5	800	240	4.0	0.9 ± 0.3	4	VDRH05E075xyE
			200	10.0	11.0	1750	530	4.0	0.9 ± 0.3	4	VDRH07K075xyE
			200	25.0	22.0	3500	1000	4.4	1.1 ± 0.3	4	VDRH10S075xyE
			200	50.0	44.0	6000	1900	4.4	1.1 ± 0.3	2	VDRH14V075xyE
			200	100.0	88.0	10 000	3800	4.8	1.3 ± 0.3	2	VDRH20X075ByE
95	125	150	260	5.0	6.5	800	180	4.2	1.1 ± 0.3	4	VDRH05E095xyE
			250	10.0	13.0	1750	450	4.2	1.1 ± 0.3	4	VDRH07K095xyE
			250	25.0	25.0	3500	800	4.6	1.3 ± 0.3	4	VDRH10S095xyE
			250	50.0	53.0	6000	1500	4.6	1.3 ± 0.3	2	VDRH14V095xyE
			250	100.0	106.0	10 000	3000	5.0	1.5 ± 0.3	2	VDRH20X095ByE
115	150	180	320	5.0	8.0	800	150	3.6	0.9 ± 0.3	4	VDRH05E115xyE
			300	10.0	16.0	1750	390	3.6	0.9 ± 0.3	4	VDRH07K115xyE
			300	25.0	32.0	3500	680	4.0	1.1 ± 0.3	3	VDRH10S115xyE
			300	50.0	65.0	6000	1320	4.0	1.1 ± 0.3	2	VDRH14V115xyE
			300	100.0	130.0	10 000	2640	4.4	1.3 ± 0.3	2	VDRH20X115ByE
130	170	205	355	5.0	8.5	800	130	3.8	1.0 ± 0.3	4	VDRH05E130xyE
			340	10.0	17.5	1750	320	3.8	1.0 ± 0.3	4	VDRH07K130xyE
			340	25.0	35.0	3500	580	4.3	1.2 ± 0.3	3	VDRH10S130xyE
			340	50.0	70.0	6000	1050	4.3	1.2 ± 0.3	2	VDRH14V130xyE
			340	100.0	140.0	10 000	2100	4.8	1.4 ± 0.3	2	VDRH20X130ByE
140	180	220	380	5.0	9.0	800	120	3.9	1.0 ± 0.3	4	VDRH05E140xyE
			360	10.0	19.0	1750	290	3.9	1.0 ± 0.3	4	VDRH07K140xyE
			360	25.0	39.0	3500	540	4.3	1.2 ± 0.3	3	VDRH10S140xyE
			360	50.0	78.0	6000	950	4.3	1.2 ± 0.3	2	VDRH14V140xyE
			360	100.0	155.0	10 000	1900	4.8	1.5 ± 0.3	2	VDRH20X140ByE
150	200	240	415	5.0	10.5	800	110	4.1	1.1 ± 0.3	4	VDRH05E150xyE
			395	10.0	21.0	1750	270	4.1	1.1 ± 0.3	4	VDRH07K150xyE
			395	25.0	42.0	3500	490	4.3	1.3 ± 0.3	3	VDRH10S150xyE
			395	50.0	84.0	6000	850	4.3	1.3 ± 0.3	2	VDRH14V150xyE
			395	100.0	168.0	10 000	1700	4.8	1.5 ± 0.3	2	VDRH20X150ByE
175	225	275	475	5.0	11.0	800	90	4.1	1.3 ± 0.3	4	VDRH05E175xyE
			455	10.0	24.0	1750	230	4.1	1.3 ± 0.3	4	VDRH07K175xyE
			455	25.0	49.0	3500	430	4.5	1.5 ± 0.3	3	VDRH10S175xyE
			455	50.0	99.0	6000	750	4.5	1.5 ± 0.3	2	VDRH14V175xyE
			455	100.0	190.0	10 000	1500	4.9	1.7 ± 0.3	2	VDRH20X175ByE
195	250	300	525	5.0	12.0	800	80	4.3	1.4 ± 0.8	4	VDRH05E195xyE
			505	10.0	26.0	1750	210	4.3	1.4 ± 0.8	4	VDRH07K195xyE
			505	25.0	52.0	3500	380	4.8	1.6 ± 0.8	4	VDRH10S195xyE
			505	50.0	105.0	6000	690	4.8	1.6 ± 0.8	2	VDRH14V195xyE
			505	100.0	210.0	10 000	1350	5.1	1.9 ± 0.8	2	VDRH20X195ByE



ELECTRICAL DATA AND ORDERING INFORMATION											
MAXIMUM CONTINUOUS VOLTAGE		VOLTAGE ⁽³⁾ at 1 mA	MAXIMUM VOLTAGE at STATED CURRENT		MAXIMUM ENERGY ⁽⁴⁾ (10 x 1000 µs)	MAXIMUM NON-REP. TRANSIENT CURRENT ⁽⁵⁾ I _{NRP} (8 x 20 µs)	TYPICAL CAPACITANCE at 1 kHz	T (max.)	E	UL 1449 ED3 SPD TYPE ⁽⁷⁾	CATALOG NUMBERS ⁽¹⁾
RMS ⁽²⁾ (V)	DC (V)	(V)	V (V)	I (A)	(J)	(A)	(pF)	(mm)	(mm)		SAP ⁽⁶⁾
210	275	330	575	5.0	13.0	800	75	4.4	1.6 ± 0.8	4	VDRH05E210xyE
			550	10.0	28.0	1750	190	4.4	1.6 ± 0.8	4	VDRH07K210xyE
			550	25.0	58.0	3500	350	4.8	1.8 ± 0.8	4	VDRH10S210xyE
			550	50.0	115.0	6000	610	4.8	1.8 ± 0.8	2	VDRH14V210xyE
			550	100.0	228.0	10 000	1250	5.3	2.0 ± 0.8	2	VDRH20X210ByE
230	300	360	620	5.0	16.0	800	70	4.6	1.7 ± 0.8	4	VDRH05E230xyE
			595	10.0	32.0	1750	170	4.6	1.7 ± 0.8	4	VDRH07K230xyE
			595	25.0	65.0	3500	320	5.1	1.9 ± 0.8	4	VDRH10S230xyE
			595	50.0	130.0	6000	540	5.1	1.9 ± 0.8	2	VDRH14V230xyE
			595	100.0	255.0	10 000	1100	5.4	2.2 ± 0.8	2	VDRH20X230ByE
250	320	390	675	5.0	17.0	800	60	4.8	1.9 ± 0.8	4	VDRH05E250xyE
			650	10.0	35.0	1750	160	4.8	1.9 ± 0.8	4	VDRH07K250xyE
			650	25.0	70.0	3500	300	5.1	2.1 ± 0.8	4	VDRH10S250xyE
			650	50.0	140.0	6000	480	5.1	2.1 ± 0.8	2	VDRH14V250xyE
			650	100.0	275.0	10 000	960	5.5	2.3 ± 0.8	2	VDRH20X250ByE
275	350	430	745	5.0	20.0	800	55	4.9	2.0 ± 0.8	4	VDRH05E275xyE
			710	10.0	40.0	1750	140	4.9	2.0 ± 0.8	4	VDRH07K275xyE
			710	25.0	80.0	3500	270	5.3	2.2 ± 0.8	4	VDRH10S275xyE
			710	50.0	155.0	6000	440	5.3	2.2 ± 0.8	5	VDRH14V275xyE
			710	100.0	303.0	10 000	900	5.8	2.5 ± 0.8	5	VDRH20X275ByE
300	385	470	810	5.0	21.0	800	50	5.1	2.2 ± 0.8	4	VDRH05E300xyE
			775	10.0	42.0	1750	130	5.1	2.2 ± 0.8	4	VDRH07K300xyE
			775	25.0	85.0	3500	240	5.5	2.4 ± 0.8	4	VDRH10S300xyE
			775	50.0	175.0	6000	400	5.5	2.4 ± 0.8	5	VDRH14V300xyE
			775	100.0	350.0	10 000	810	5.9	2.7 ± 0.8	5	VDRH20X300ByE
320	420	510	880	5.0	22.0	800	45	5.5	2.4 ± 0.8	4	VDRH05E320xyE
			842	10.0	45.0	1750	120	5.5	2.4 ± 0.8	4	VDRH07K320xyE
			842	25.0	92.0	3500	220	6.0	2.6 ± 0.8	4	VDRH10S320xyE
			842	50.0	190.0	6000	370	6.0	2.6 ± 0.8	5	VDRH14V320xyE
			842	100.0	382.0	10 000	750	6.3	2.9 ± 0.8	5	VDRH20X320ByE
350	460	560	940	5.0	25.0	800	42	5.8	2.7 ± 0.8	4	VDRH05E350xyE
			920	10.0	51.0	1750	110	5.8	2.7 ± 0.8	4	VDRH07K350xyE
			920	25.0	102.0	3500	200	6.1	2.9 ± 0.8	4	VDRH10S350xyE
			920	50.0	205.0	6000	320	6.1	2.9 ± 0.8	2	VDRH14V350xyE
			920	100.0	410.0	10 000	650	6.5	3.2 ± 0.8	2	VDRH20X350ByE
385	505	620	1050	5.0	27.0	800	40	6.0	3.0 ± 0.8	4	VDRH05E385xyE
			1025	10.0	54.0	1750	95	6.0	3.0 ± 0.8	4	VDRH07K385xyE
			1025	25.0	107.0	3500	180	6.5	3.2 ± 0.8	3	VDRH10S385xyE
			1025	50.0	215.0	6000	280	6.5	3.2 ± 0.8	2	VDRH14V385xyE
			1025	100.0	420.0	10 000	570	6.8	3.5 ± 0.8	2	VDRH20X385ByE
420	560	680	1150	5.0	28.0	800	35	6.3	3.2 ± 0.8	4	VDRH05E420xyE
			1120	10.0	56.0	1750	85	6.3	3.2 ± 0.8	4	VDRH07K420xyE
			1120	25.0	112.0	3500	165	6.7	3.4 ± 0.8	3	VDRH10S420xyE
			1120	50.0	225.0	6000	250	6.7	3.4 ± 0.8	2	VDRH14V420xyE
			1120	100.0	430.0	10 000	510	7.1	3.7 ± 0.8	2	VDRH20X420ByE



ELECTRICAL CHARACTERISTICS

ELECTRICAL DATA		
PARAMETER	VALUE	UNIT
Maximum continuous voltage:		
RMS	11 to 680	V
DC	14 to 895	V
Maximum non-repetitive transient current (I_{NRP}) (8 x 20 μ s)		
VDRH05	250 or 800	A
VDRH07	500 or 1750	A
VDRH10	1000 or 3500	A
VDRH14	2000 or 6000	A
VDRH20	3000 or 10 000	A
Thermal resistance:		
VDRH05	\approx 80	K/W
VDRH07	\approx 70	K/W
VDRH10	\approx 60	K/W
VDRH14	\approx 50	K/W
VDRH20	\approx 40	K/W
Maximum dissipation:		
VDRH05	100	mW
VDRH07	250	mW
VDRH10	400	mW
VDRH14	600	mW
VDRH20	1000	mW
Temperature coefficient of voltage at 1 mA maximum	\pm 0.05	%/K
Voltage proof between interconnected leads and case	2500	V
Storage temperature	-40 to +150	$^{\circ}$ C
Operating temperature	-40 to +125	$^{\circ}$ C

DERATING CURVE

Maximum Voltage
Maximum Dissipation
Maximum Energy
Maximum Transient Current



PEAK CURRENT AS A FUNCTION OF PULSE WIDTH

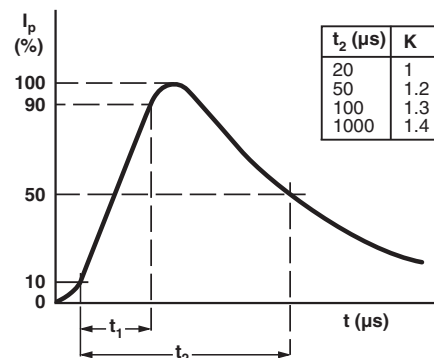

COMPONENT DIMENSIONS (BULK TYPE) in millimeters AND CATALOG NUMBERS

D MAX.		A MAX.		A ₀ MAX.		L MIN.	T ⁽¹⁾ MAX.	E ⁽¹⁾	d	F	CATALOG NUMBER
V \leq 320 V	V > 320 V	V \leq 300 V	V > 300 V	V \leq 320 V	V > 320 V						
7.0		9.0		11.0		24.0	6.5	0.7 to 3.6	0.6 \pm 0.05	5 \pm 1.0	VDRH05
	9.0	11.0		13.0		24.0	6.5	0.7 to 3.6	0.6 \pm 0.05	5 \pm 1.0	VDRH07
12.0	12.5	14.5	15.0	16.5	17.0	17.0	8.0	0.9 to 4.5	0.8 \pm 0.05	7.5 \pm 1.0	VDRH10
16.0	16.5	19.0		21.0	21.5	16.0	8.0	0.9 to 4.5	0.8 \pm 0.05	7.5 \pm 1.0	VDRH14
22.5	23.0	25.5		27.5	28.0	24.0	10.0	1.1 to 5.8	1.0 \pm 0.05	10 \pm 1.0	VDRH20

Note

⁽¹⁾ T_{max} . and E values per size and voltage level can be found back in the Electrical Data table

VARISTORS IN BULK					
TYPE	VDRH05.... Ø 5 mm 11 V to 460 V	VDRH07.... Ø 7 mm 11 V to 510 V	VDRH10.... Ø 10 mm 11 V to 680 V	VDRH14.... Ø 14 mm 11 V to 680 V	VDRH20.... Ø 20 mm 11 V to 680 V
Straight leads; see outline of components with straight leads drawing	BSE	BSE	BSE	BSE	BSE
Kinked leads; see outline of components with kinked leads drawing	BKE	BKE	BKE	BKE	BKE
Packaging quantities					
11 V to 95 V	250	250	250	100	50
130 V to 385 V	250	250	250	100	50
420 V to 460 V	250	250	200	100	50
485 V to max. V	-	250	150	100	50

DIMENSIONS in millimeters: See Component Dimensions and Electrical Data table

OUTLINE of Component with Straight Leads

OUTLINE of Component with Kinked Leads



VARISTORS ON TAPE IN AMMOPACK				
TYPE	VDRH05.... Ø 5 mm 11 V to 460 V	VDRH07.... Ø 7 mm 11 V to 510 V	VDRH10.... Ø 10 mm 11 V to 680 V	VDRH14.... Ø 14 mm 11 V to 680 V
Straight leads H = 18 mm H = 20 mm See drawing: taped version with straight leads	-	-	ASE	ASE
Kinked leads H ₀ = 18.25 mm H ₀ = 16 mm See drawing: taped version with kinked leads	AME ALE	AME ALE	AME ALE	AME ALE
Packaging quantities				
14 V to 210 V	1500 ⁽¹⁾	1500 ⁽¹⁾	500	500
230 V to 510 V	1000	1000	500	500
550 V to max. V	-	-	400	400

Note

(1) Except for 35 V and 40 V = 1000 pieces

DIMENSIONS OF AMMOPACK in millimeters



VARISTORS ON TAPE AND REEL				
TYPE	VDRH05.... Ø 5 mm 11 V to 460 V	VDRH07.... Ø 7 mm 11 V to 510 V	VDRH10.... Ø 10 mm 11 V to 680 V	VDRH14.... Ø 14 mm 11 V to 680 V
H = 18 mm H = 20 mm See drawing: taped version with straight leads	Straight leads -	-	TSE	TSE
Kinked leads H ₀ = 18.25 mm H ₀ = 16 mm See drawing: taped version with kinked leads	TME TLE	TME TLE	TME TLE	TME TLE
Packaging quantities				
14 V to 250 V	1500	1500	1000	750
275 V to 300 V	1500	1500	750	750
320 V to 350 V	1000	1000	500	500
385 V to max. V	1000	1000	500	500

PACKAGING
TAPED VERSION WITH STRAIGHT LEADS (only for VDRH05 and VDRH07)

TAPED VERSION WITH STRAIGHT LEADS (only for VDRH10 and VDRH14)

TAPED VERSION WITH KINKED LEADS

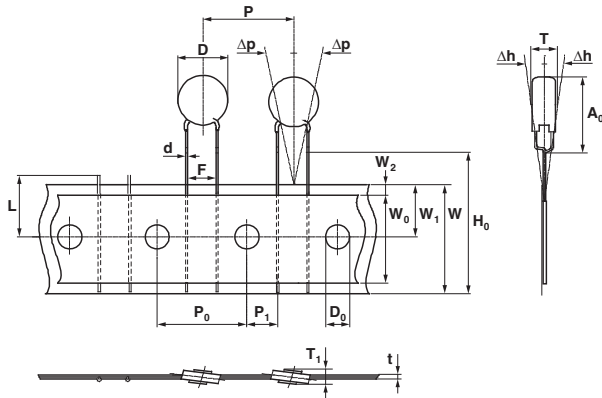
(only for VDRH05 and VDRH07)

TAPED VERSION WITH KINKED LEADS

(only for VDRH10 and VDRH14)

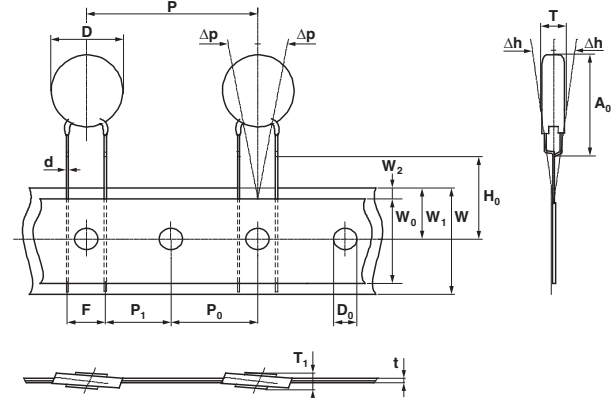

TAPING DATA (based on IEC 60286-2)						
SYMBOL	PARAMETER		DIMENSIONS/TOLERANCE			
			VDRH05	VDRH07	VDRH10	VDRH14
A max.	Max. mounting height	$V \leq 300 \text{ V}$	9.0	11.0	14.5	19.0
		$V > 300 \text{ V}$			15.0	
A_0 max.	Max. mounting height	$V \leq 320 \text{ V}$	11.0	13.0	16.5	21.0
		$V > 320 \text{ V}$			17.0	21.5
D max.	Max. body diameter	$V \leq 320 \text{ V}$	7.0	9.0	12.0	16.0
		$V > 320 \text{ V}$			12.5	16.5
d	Lead wire diameter		0.6 ± 0.05		0.8 ± 0.05	
F	Lead to lead distance ⁽¹⁾		5.0 + 0.8/- 0.2		7.5 ± 0.8	
H	Distance component to tape center ⁽²⁾		20.0 + 2.0/- 0.0		18.0 + 2.0/- 0.0	
H_0	Lead wire clinch height		16.0 or 18.25 ± 0.5			
P	Pitch of components on tape		12.7 ± 1.0		25.4 ± 1.0	
T	Total thickness		See Electrical Data table			

Notes

- (1) Guaranteed between component and tape
 (2) For VDRH14V510xSE and VDRH14V550xSE: H = 20 mm ± 1 mm



V/I CHARACTERISTICS

11 V_{RMS} to 40 V_{RMS}; VDRH05



50 V_{RMS} to 195 V_{RMS}; VDRH05





210 V_{RMS} to 460 V_{RMS}; VDRH05

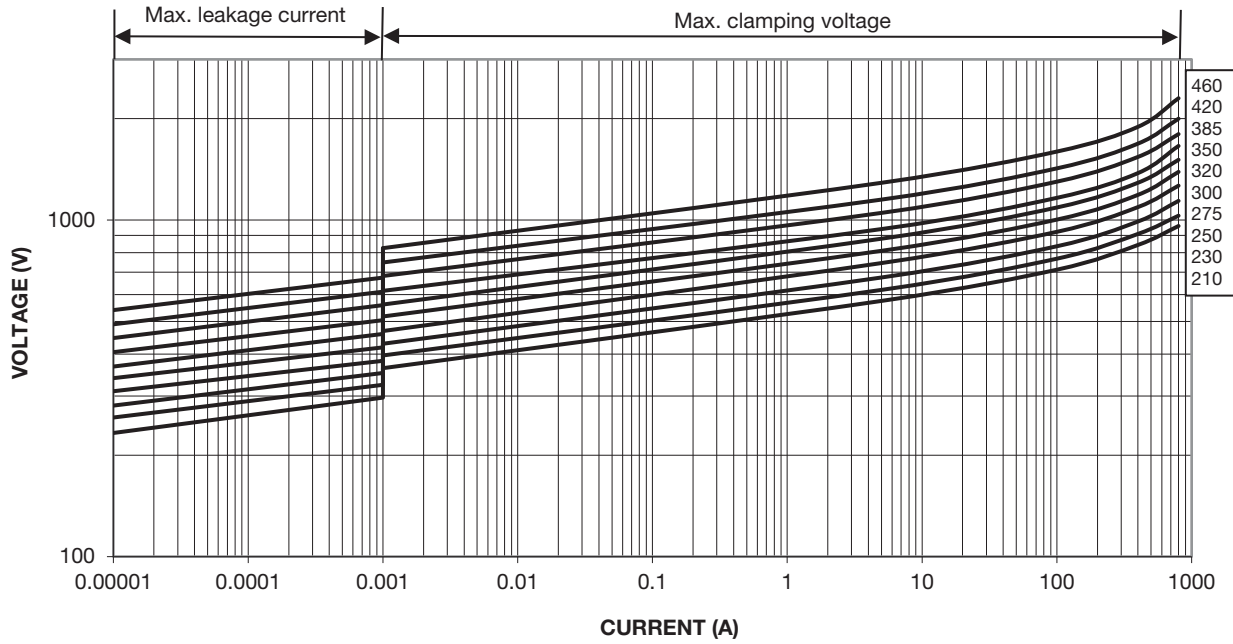

11 V_{RMS} to 40 V_{RMS}; VDRH07

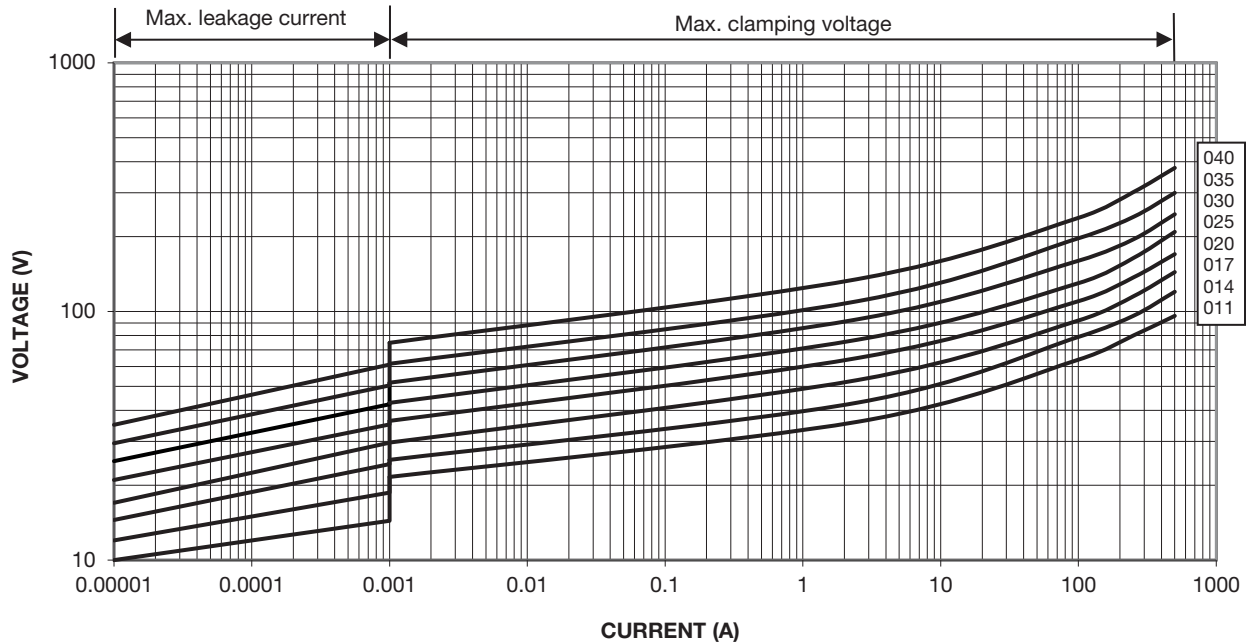



50 V_{RMS} to 210 V_{RMS}; VDRH07



230 V_{RMS} to 510 V_{RMS}; VDRH07





11 V_{RMS} to 40 V_{RMS}; VDRH10

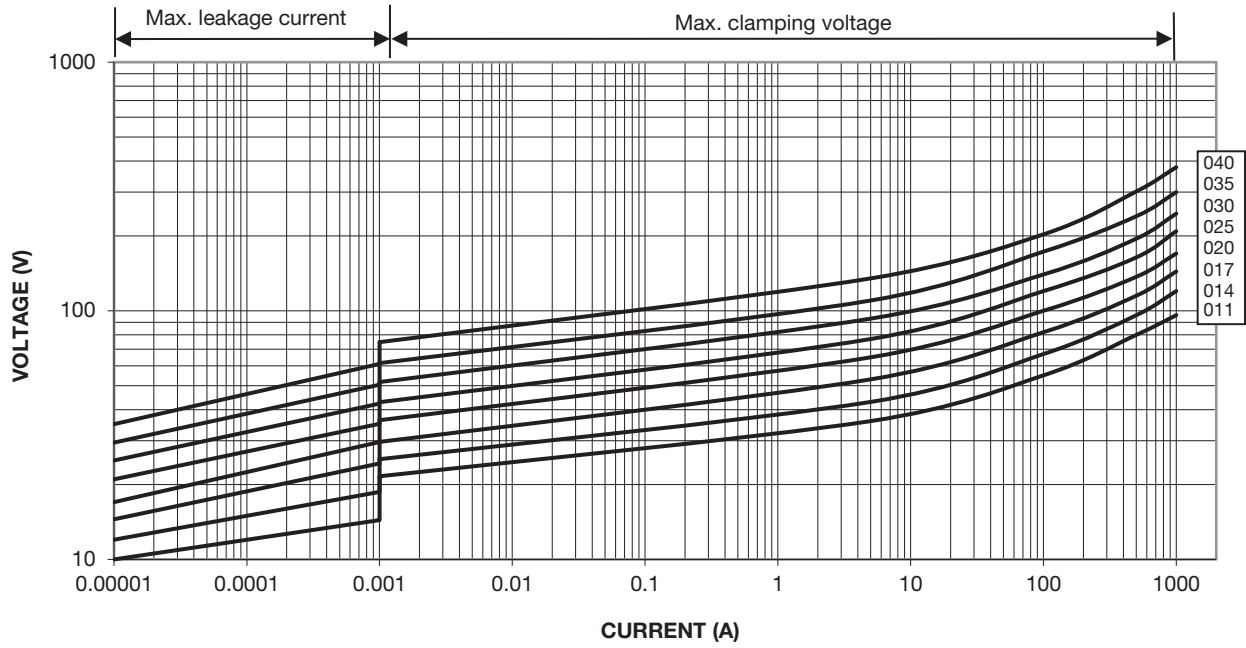

50 V_{RMS} to 210 V_{RMS}; VDRH10

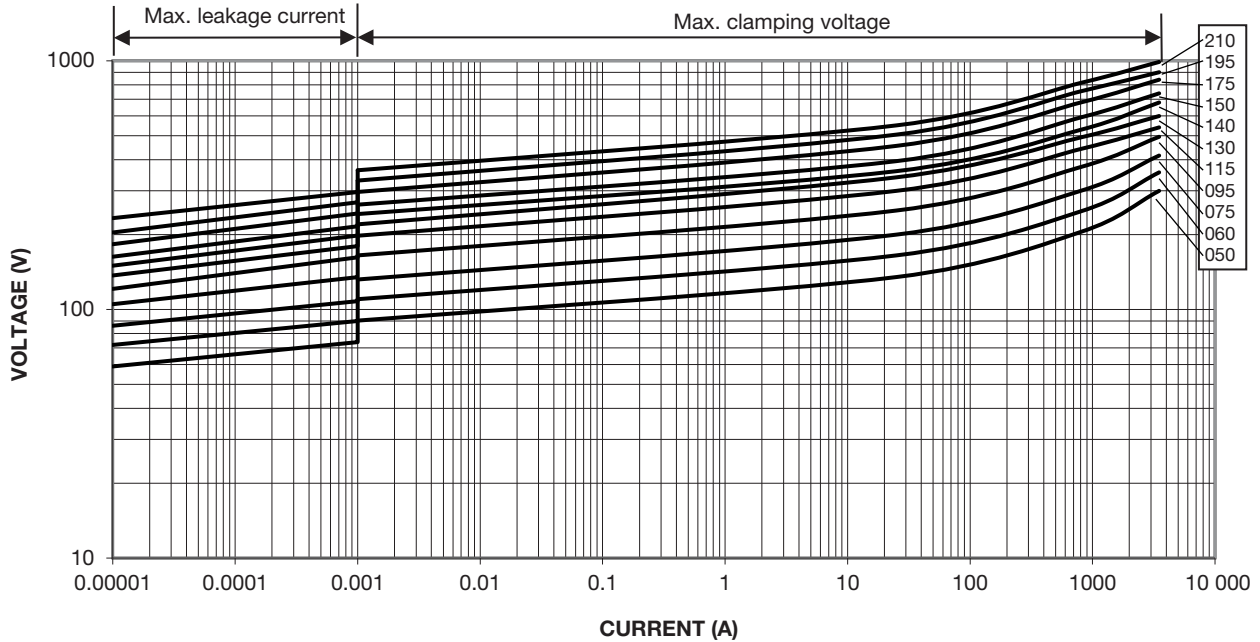



230 V_{RMS} to 680 V_{RMS}; VDRH10

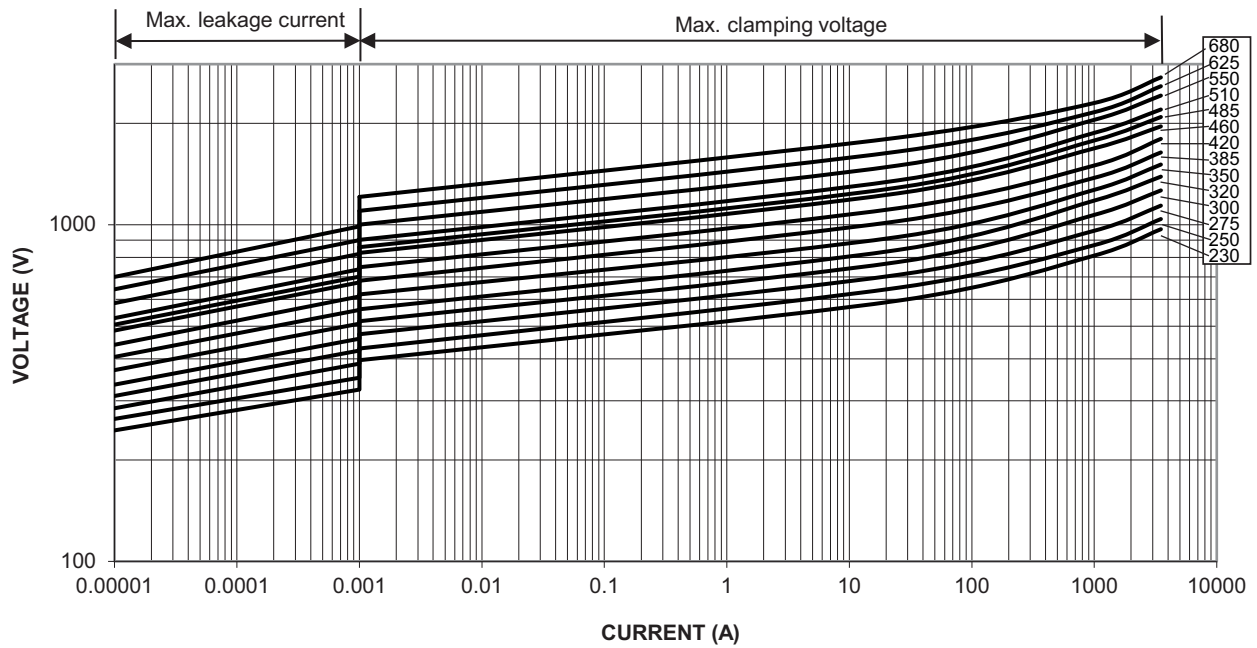

11 V_{RMS} to 40 V_{RMS}; VDRH14

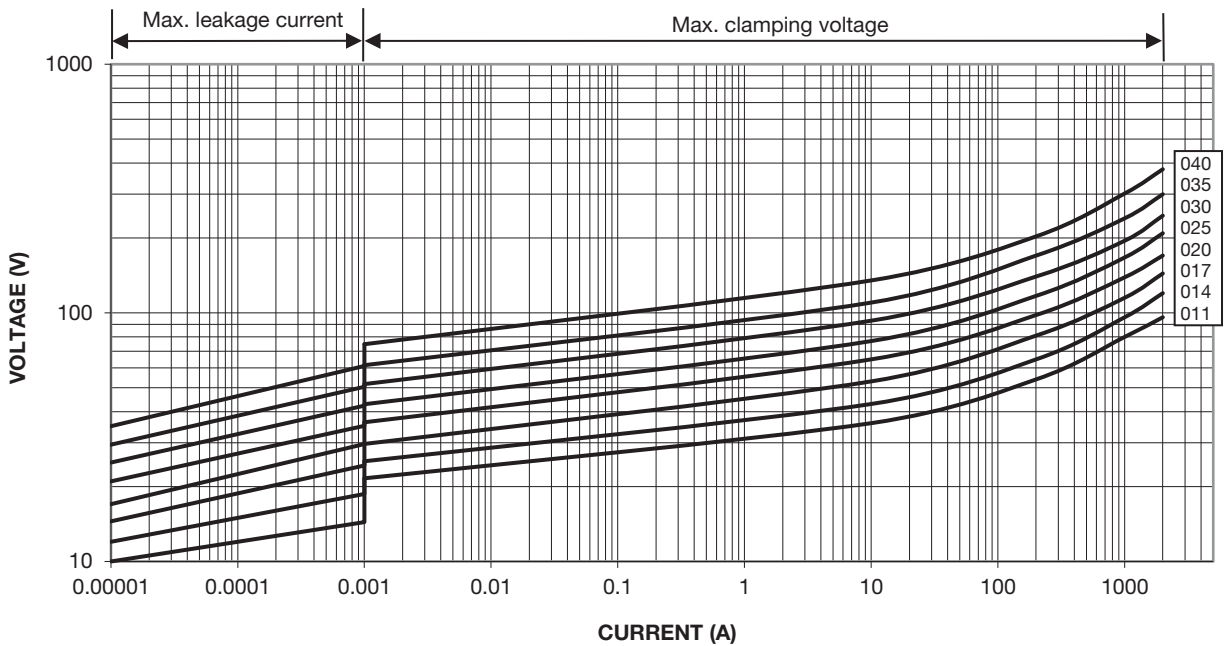



50 V_{RMS} to 210 V_{RMS}; VDRH14

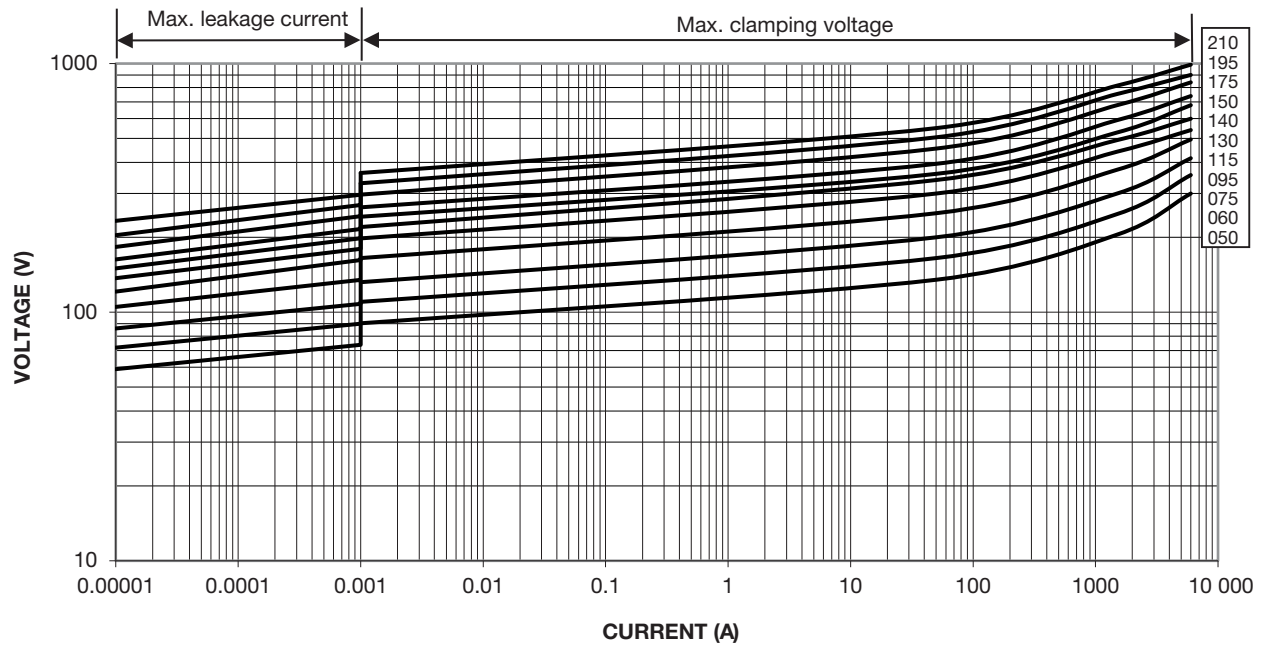

230 V_{RMS} to 680 V_{RMS}; VDRH14

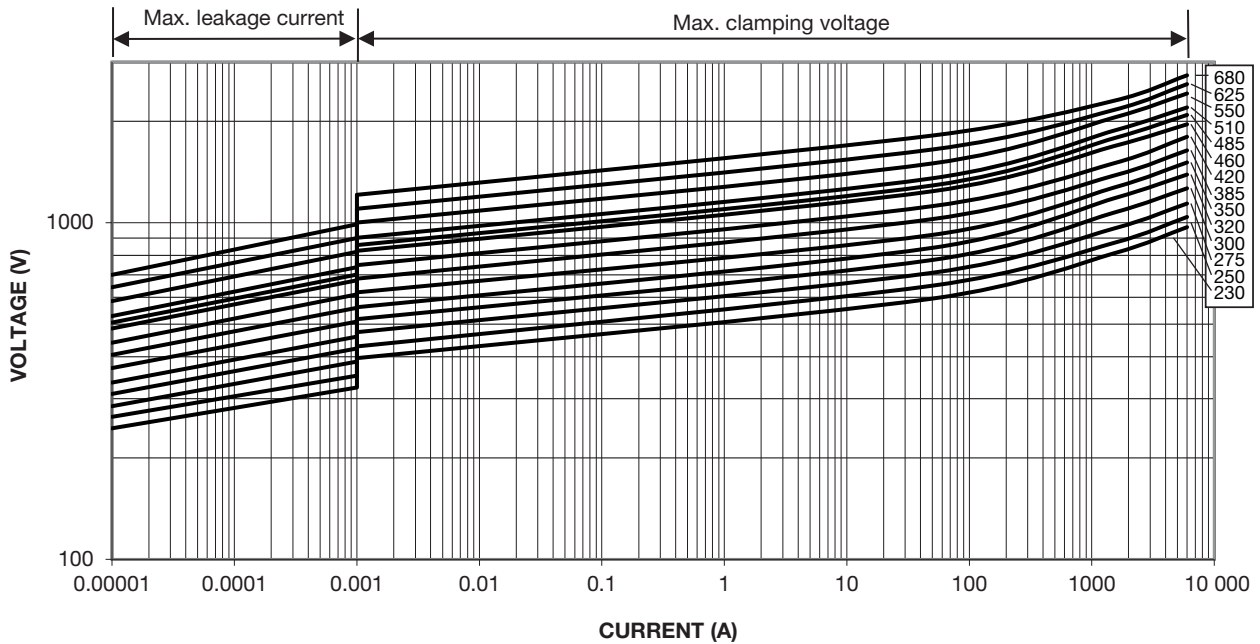



14 V_{RMS} to 40 V_{RMS}; VDRH20



60 V_{RMS} to 210 V_{RMS}; VDRH20





230 V_{RMS} to 680 V_{RMS}; VDRH20

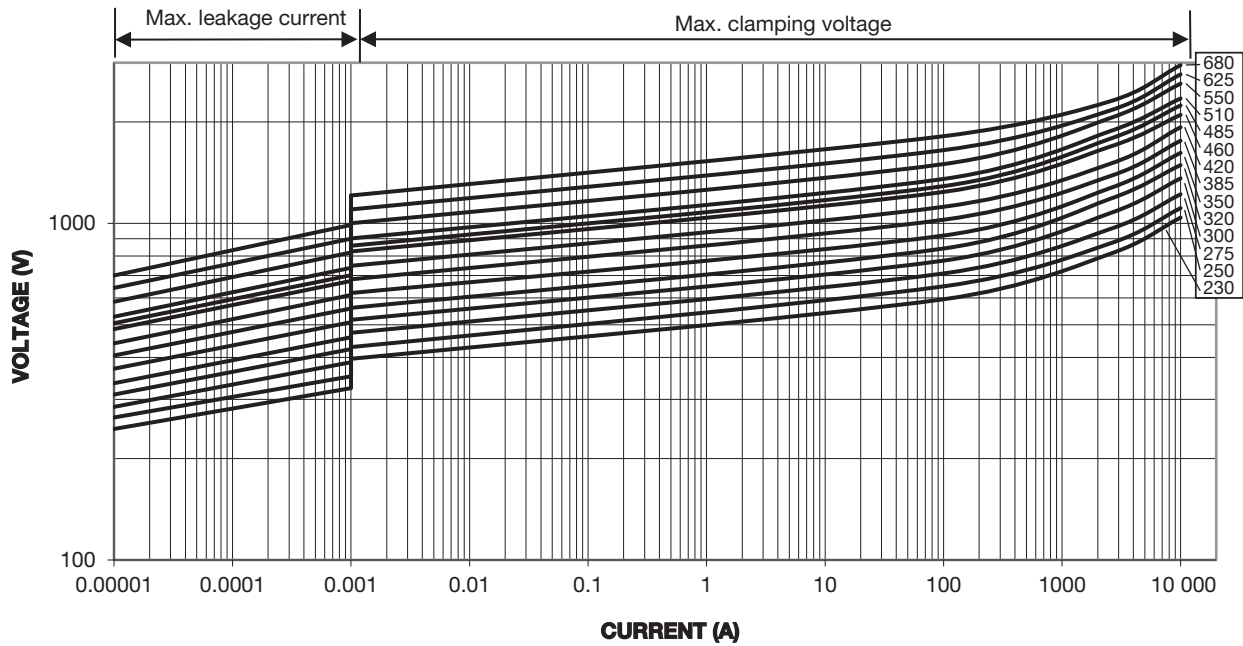

MAXIMUM APPLICABLE TRANSIENT CURRENT AS A FUNCTION OF PULSE DURATION

11 V_{RMS} to 40 V_{RMS}; VDRH05





50 V_{RMS} to 460 V_{RMS}; VDRH05



11 V_{RMS} to 40 V_{RMS}; VDRH07





50 V_{RMS} to 510 V_{RMS}; VDRH07

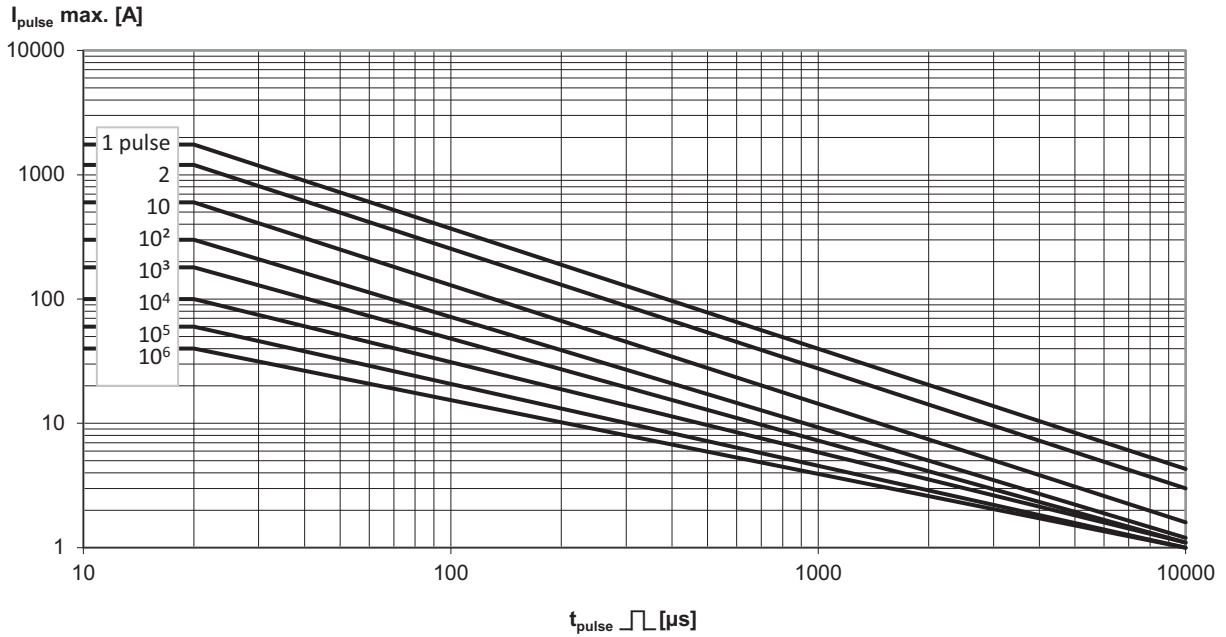

11 V_{RMS} to 40 V_{RMS}; VDRH10





50 V_{RMS} to 300 V_{RMS}; VDRH10



320 V_{RMS} to 680 V_{RMS}; VDRH10

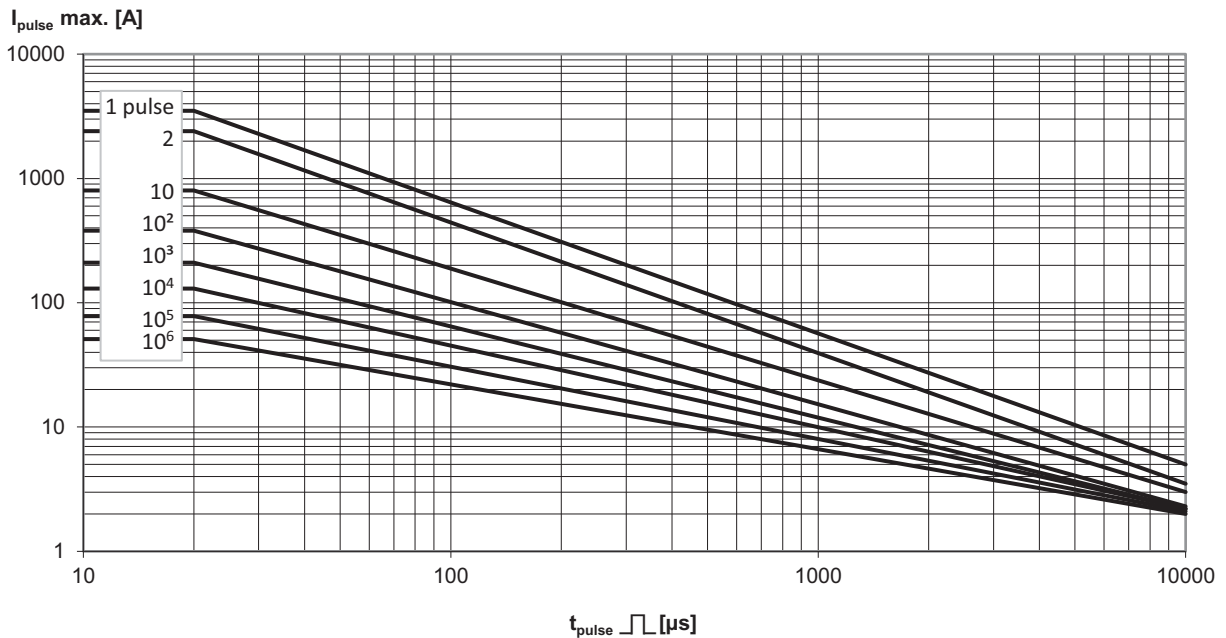



11 V_{RMS} to 40 V_{RMS}; VDRH14



50 V_{RMS} to 300 V_{RMS}; VDRH14





320 V_{RMS} to 680 V_{RMS}; VDRH14



14 V_{RMS} to 40 V_{RMS}; VDRH20





60 V_{RMS} to 300 V_{RMS}; VDRH20



320 V_{RMS} to 680 V_{RMS}; VDRH20





Disclaimer

ALL PRODUCT, PRODUCT SPECIFICATIONS AND DATA ARE SUBJECT TO CHANGE WITHOUT NOTICE TO IMPROVE RELIABILITY, FUNCTION OR DESIGN OR OTHERWISE.

Vishay Intertechnology, Inc., its affiliates, agents, and employees, and all persons acting on its or their behalf (collectively, "Vishay"), disclaim any and all liability for any errors, inaccuracies or incompleteness contained in any datasheet or in any other disclosure relating to any product.

Vishay makes no warranty, representation or guarantee regarding the suitability of the products for any particular purpose or the continuing production of any product. To the maximum extent permitted by applicable law, Vishay disclaims (i) any and all liability arising out of the application or use of any product, (ii) any and all liability, including without limitation special, consequential or incidental damages, and (iii) any and all implied warranties, including warranties of fitness for particular purpose, non-infringement and merchantability.

Statements regarding the suitability of products for certain types of applications are based on Vishay's knowledge of typical requirements that are often placed on Vishay products in generic applications. Such statements are not binding statements about the suitability of products for a particular application. It is the customer's responsibility to validate that a particular product with the properties described in the product specification is suitable for use in a particular application. Parameters provided in datasheets and / or specifications may vary in different applications and performance may vary over time. All operating parameters, including typical parameters, must be validated for each customer application by the customer's technical experts. Product specifications do not expand or otherwise modify Vishay's terms and conditions of purchase, including but not limited to the warranty expressed therein.

Except as expressly indicated in writing, Vishay products are not designed for use in medical, life-saving, or life-sustaining applications or for any other application in which the failure of the Vishay product could result in personal injury or death. Customers using or selling Vishay products not expressly indicated for use in such applications do so at their own risk. Please contact authorized Vishay personnel to obtain written terms and conditions regarding products designed for such applications.

No license, express or implied, by estoppel or otherwise, to any intellectual property rights is granted by this document or by any conduct of Vishay. Product names and markings noted herein may be trademarks of their respective owners.