

High Current, Pressed, Power Inductors

HCP0703 Series

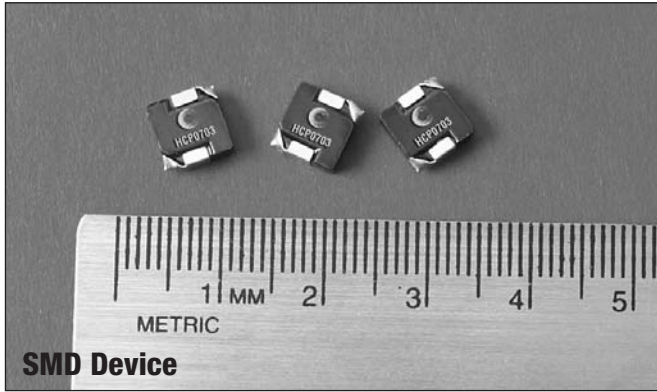

SMD Device

Description

- 125°C maximum total temperature operation
- 7.0 x 7.3 x 3.0mm surface mount package
- Magnetically shielded, low EMI
- Pressed powder iron core material
- Enhanced core coating eliminates rusting and provides high insulation impedance
- Inductance range from 0.15µH to 10.0µH
- Current range from 52.0 Amps to 3.0 Amps
- Frequency range up to 1MHz
- Black or gray aesthetic color

Applications

- Notebook power
- VRM, multi-phase buck regulator
- DC-DC converters
- PC workstations/Servers/Desktop
- Routers



Environmental Data

- Storage temperature range: -55°C to +125°C
- Operating temperature range: -55°C to +125°C (range is application specific)
- Solder reflow temperature: +260°C max. for 10 seconds maximum

Packaging

- Supplied in tape and reel packaging, 1500 parts per reel, 13" diameter reel

Product Specifications

Part Number ⁵	Rated Inductance (µH)	OCL ¹ µH ± 20%	I _{rms} ² Amps	I _{sat} ³ Amps	DCR mΩ@20°C (Typical)	DCR mΩ@20°C (Maximum)	K-factor ⁴
HCP0703-R15-R	0.15	0.15	26	52	1.9	2.5	1100
HCP0703-R22-R	0.22	0.22	23	40	2.5	2.8	922
HCP0703-R47-R	0.47	0.47	17	26	4.0	4.2	559
HCP0703-R68-R	0.68	0.68	15	25	5.0	5.5	435
HCP0703-R82-R	0.82	0.82	13	24	6.8	8.0	360
HCP0703-1R0-R	1.0	1.0	11	22	9.0	10	356
HCP0703-1R5-R	1.5	1.5	9	18	14	15	307
HCP0703-2R2-R	2.2	2.2	8	14	18	20	206
HCP0703-3R3-R	3.3	3.3	6	13.5	28	30	186
HCP0703-4R7-R	4.7	4.7	5.5	10	37	40	171
HCP0703-6R8-R	6.8	6.8	4.5	8	54	60	140
HCP0703-8R2-R	8.2	8.2	4	7.5	64	68	132
HCP0703-100-R	10.0	10.0	3	7.0	102	105	112

1 Open Circuit Inductance (OCL) Test Parameters: 100kHz, 0.25V, 0.0Adc
 2 I_{rms}: DC current for an approximate ΔT rise of 40°C without core loss. Derating is necessary for AC currents. PCB layout, trace thickness and width, air-flow and proximity of other heat generating components will affect the temperature rise. It is recommended the part temperature not exceed 125°C under worst case operating conditions verified in the end application.
 3 I_{sat}: Amps for approximately 20% rolloff (@25°C).

4 K-factor: Used to determine B_{p-p} for core loss (see graph). B_{p-p} = K * L * ΔI, B_{p-p}: (Gauss), K: (K-factor from table), L: (inductance in µH), ΔI (peak-to-peak ripple current in amps).
 5 Part Number Definition: HCP0703-xxx-R
 • HCP0703 = Product code and size
 • xxx= Inductance value in µH, R = decimal point. If no "R" is present, then third character = # of zeros
 • "-R" suffix = RoHS compliant

Dimensions - mm

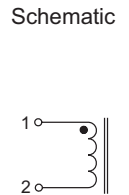
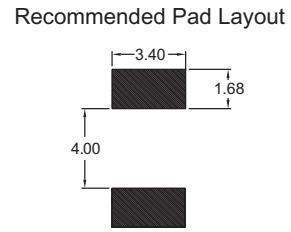
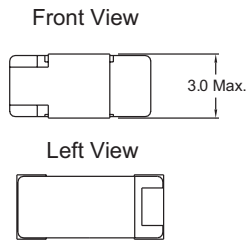
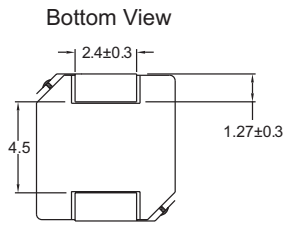
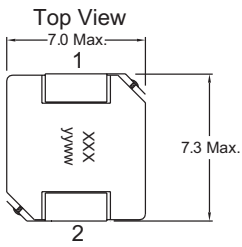

Part Marking: HCP0703

xxx = Inductance value in μH . (R = Decimal point). If no "R" is present, then last character is # of zeros

yyww = Date code

Packaging Information - mm

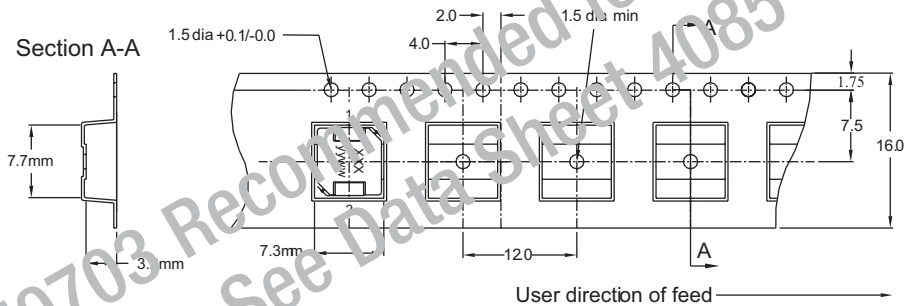

Supplied in tape and reel packaging, 1500 parts per reel, 13" diameter reel.

Core Loss

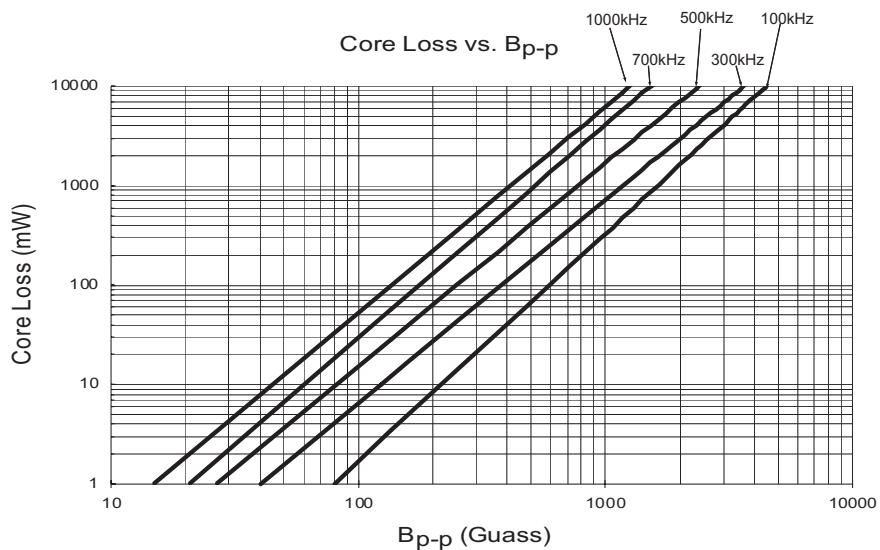

Performance Graphs

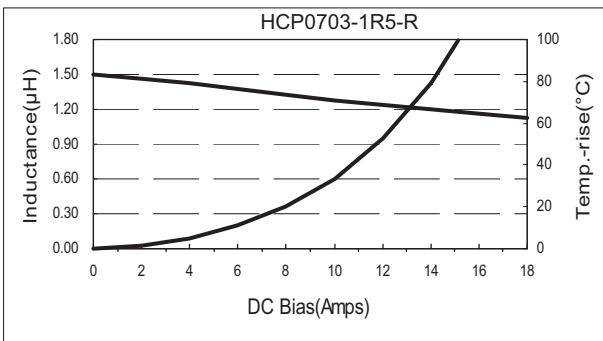
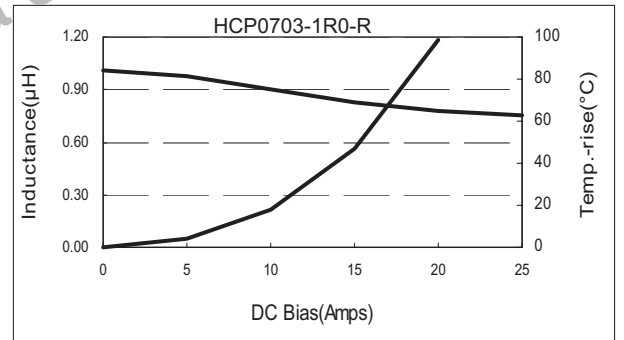
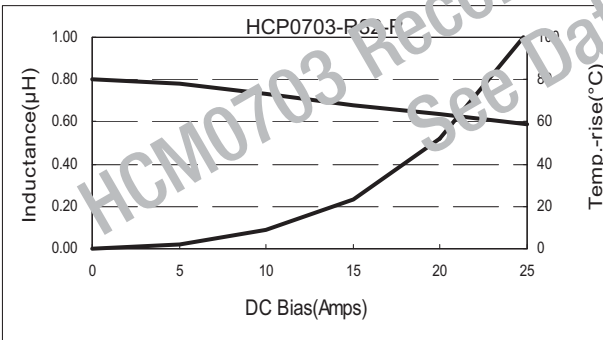
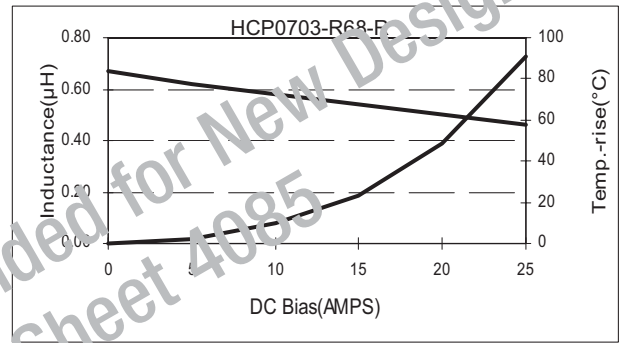
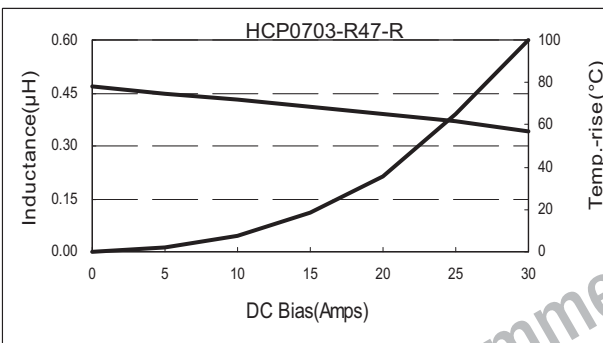
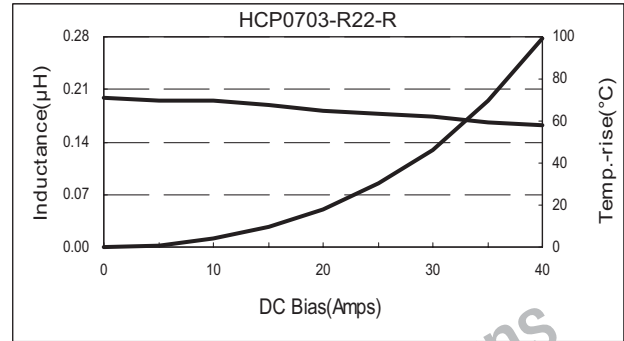
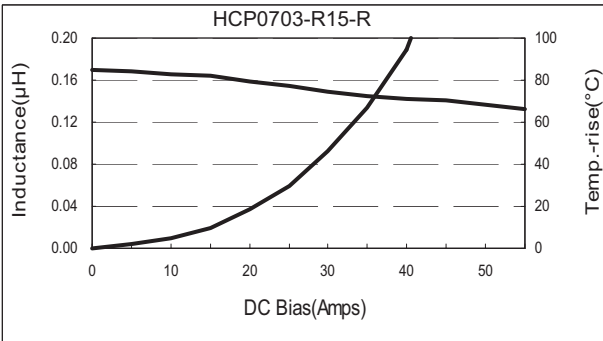

HCP0703 Recommended for New Designs
See Data Sheet 4085



Performance Graphs

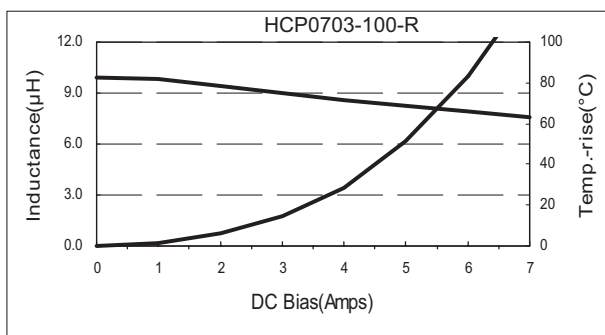
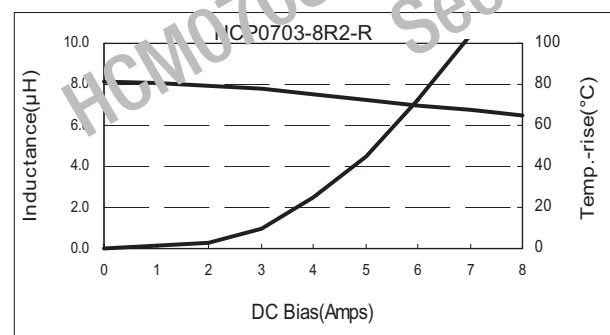
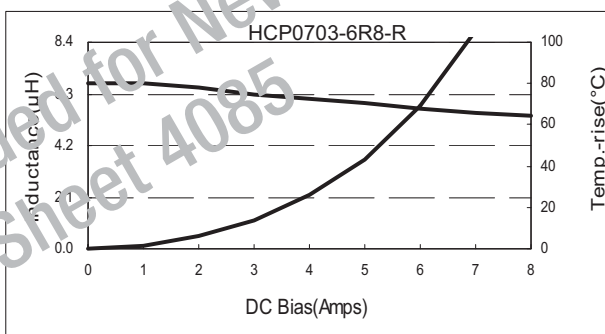
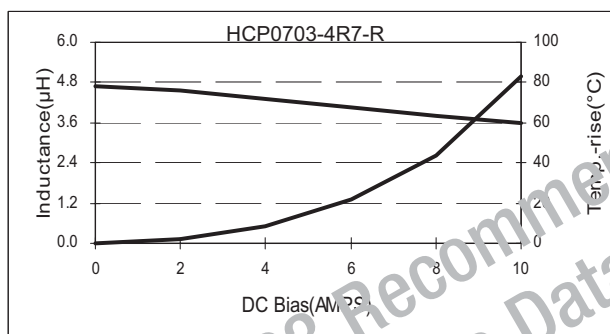
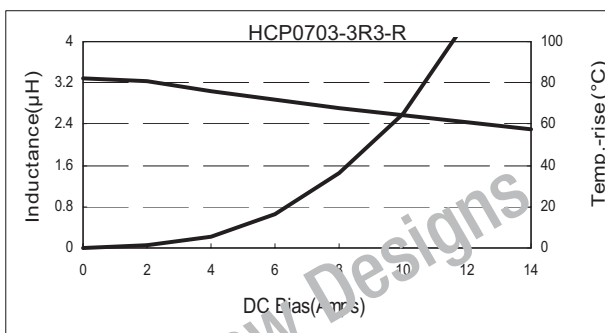
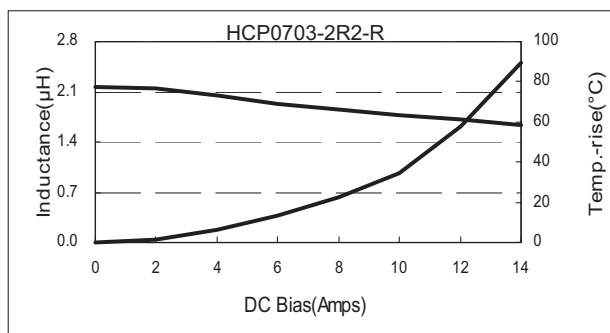

North America

Cooper Electronic Technologies
1225 Broken Sound Parkway NW
Suite F
Boca Raton, FL 33487-3533
Tel: 1-561-998-4100
Fax: 1-561-241-6640
Toll Free: 1-888-414-2645

Cooper Bussmann
P.O. Box 14460
St. Louis, MO 63178-4460
Tel: 1-636-394-2877
Fax: 1-636-527-1607

Europe

Cooper Electronic Technologies
Cooper (UK) Limited
Burton-on-the-Wolds
Leicestershire • LE12 5TH UK
Tel: +44 (0) 1509 882 737
Fax: +44 (0) 1509 882 786

Cooper Electronic Technologies
Avda. Santa Eulalia, 290
08223
Terrassa, (Barcelona), Spain
Tel: +34 937 362 812
+34 937 362 813
Fax: +34 937 362 719

Asia Pacific

Cooper Electronic Technologies
1 Jalan Kilang Timor
#06-01 Pacific Tech Centre
Singapore 159303
Tel: +65 278 6151
Fax: +65 270 4160

The only controlled copy of this Data Sheet is the electronic read-only version located on the Cooper Bussmann Network Drive. All other copies of this document are by definition uncontrolled. This bulletin is intended to clearly present comprehensive product data and provide technical information that will help the end user with design applications. Cooper Bussmann reserves the right, without notice, to change design or construction of any products and to discontinue or limit distribution of any products. Cooper Bussmann also reserves the right to change or update, without notice, any technical information contained in this bulletin. Once a product has been selected, it should be tested by the user in all possible applications.

Life Support Policy: Cooper Bussmann does not authorize the use of any of its products for use in life support devices or systems without the express written approval of an officer of the Company. Life support systems are devices which support or sustain life, and whose failure to perform, when properly used in accordance with instructions for use provided in the labeling, can be reasonably expected to result in significant injury to the user.

©2010 Cooper Bussmann
St. Louis, MO 63178
www.cooperbussmann.com

