

CDBT-54/S/C/A-G

Reverse Voltage: 30 Volts
Forward Current: 200 mA
RoHS Device

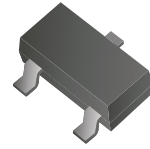

Features

- Design for mounting on small surface.
- High speed switching application, circuit protection.
- Low forward voltage drop.

Mechanical data

- Case: SOT-23, molded plastic.
- Terminals: solderable per MIL-STD-750, method 2026.
- Approx. weight: 0.008 grams
- Packing : 3,000 pieces per 7" reel.

Circuit diagram

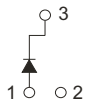

CDBT-54-G

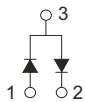

CDBT-54S-G

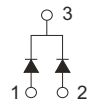

CDBT-54C-G

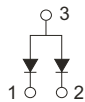

CDBT-54A-G

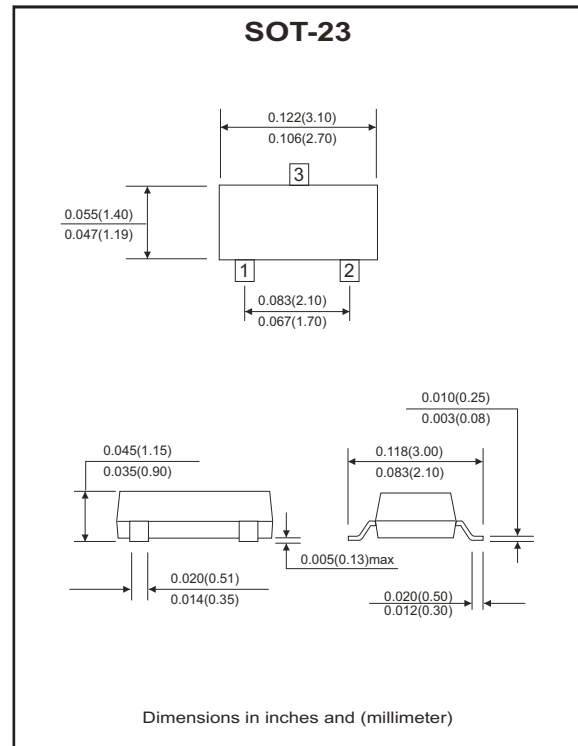

Maximum Ratings and Electrical Characteristics

(at Ta=25°C unless otherwise noted)

Parameter	Symbol	Conditions	Value	Units
Repetitive peak reverse voltage	V _{RRM}		30	V
Reverse voltage	V _R		30	V
Forward current	I _F		200	mA
Peak surge forward current	I _{FSM}	T<1.0 sec	600	mA
Power dissipation	P _d		225	mW
Maximum forward voltage	V _F	@I _F =0.1mA @I _F =1mA @I _F =10mA @I _F =30mA @I _F =100mA	0.24 0.32 0.40 0.50 1.00	V
Maximum reverse current	I _R	@V _R =25V	2	μA
Maximum reverse recovery time	T _{rr}	I _F =I _R =10mA, R _L =100Ω	5	nS
Maximum diode capacitance	C _J	V _R =1V, f=1.0MHz	10	pF
Maximum junction temperature	T _J		125	°C
Storage temperature	T _{STG}		-55 to +125	°C

RATING AND CHARACTERISTIC CURVES (CDBT-54/S/C/A-G)

Fig.1- Forward characteristics

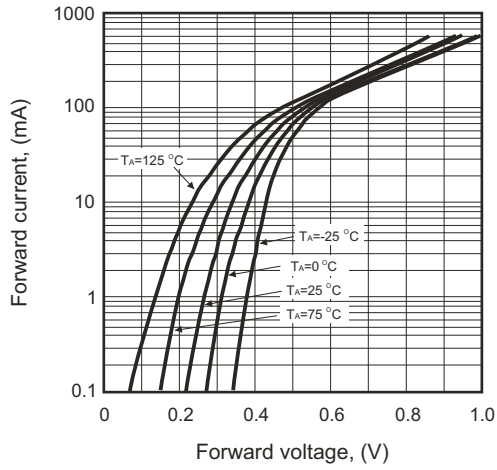

Fig.2- Reverse characteristics

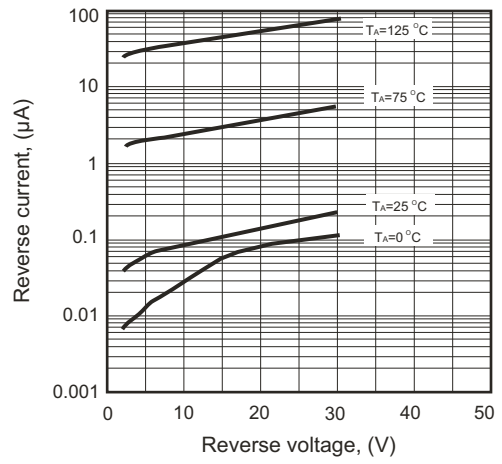

Fig.3- Capacitance between terminals characteristics

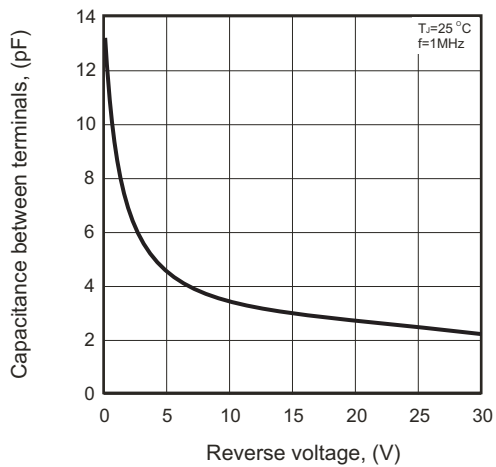
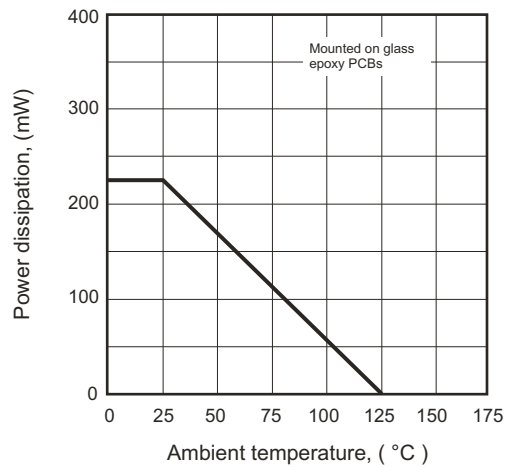
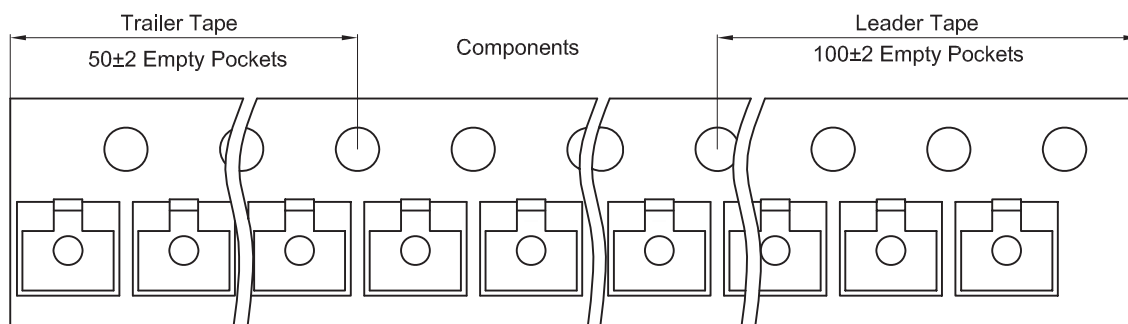
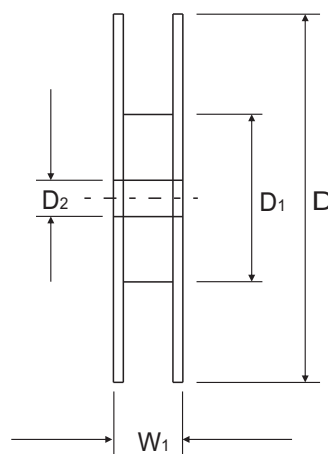
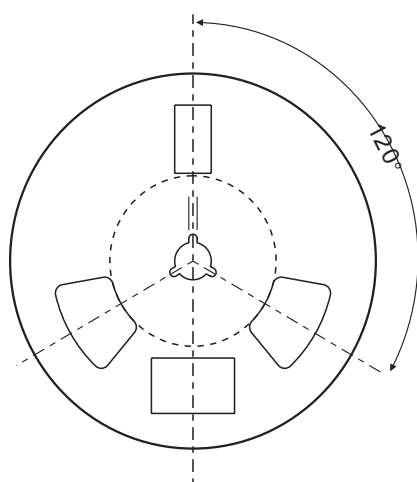
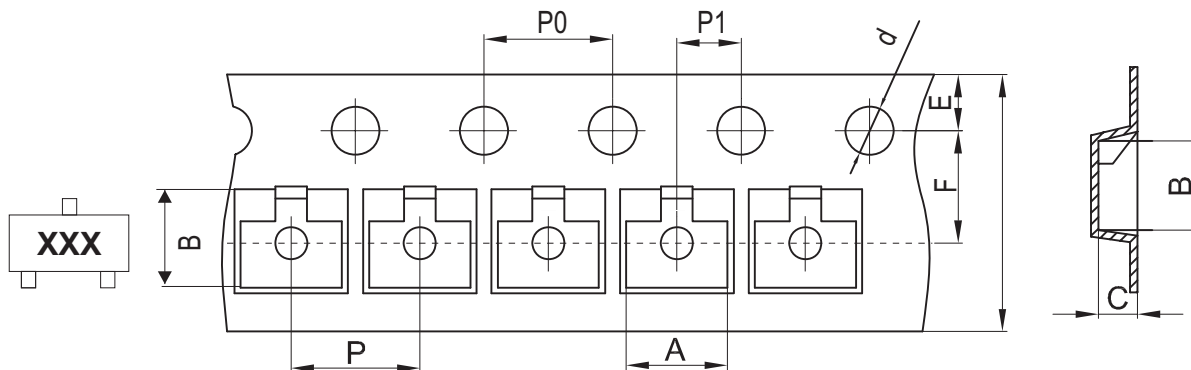

Fig.4- Power derating curve



Reel Taping Specification



SOT-23	SYMBOL	A	B	C	d	D	D1	D2
	(mm)	3.15 ± 0.10	2.77 ± 0.10	1.22 ± 0.10	1.50 ± 0.10	178 ± 2.00	54.40 ± 1.00	13.00 ± 1.00
	(inch)	0.124 ± 0.004	0.109 ± 0.004	0.048 ± 0.004	0.059 ± 0.004	7.008 ± 0.079	2.142 ± 0.039	0.512 ± 0.039

SOT-23	SYMBOL	E	F	P	P0	P1	W	W1
	(mm)	1.75 ± 0.10	3.50 ± 0.10	4.00 ± 0.10	4.00 ± 0.10	2.00 ± 0.10	8.00 + 0.30 / - 0.10	12.30 ± 1.0
	(inch)	0.069 ± 0.004	0.138 ± 0.004	0.157 ± 0.004	0.157 ± 0.004	0.079 ± 0.004	0.315 + 0.012 / - 0.004	0.484 ± 0.039

Marking Code

Part Number	Marking Code	
CDBT-54-G	KL1	JV3 ≍
CDBT-54A-G	KL2	B6 ≍
CDBT-54C-G	KL3	5C ≍
CDBT-54S-G	KL4	LD3 ≍

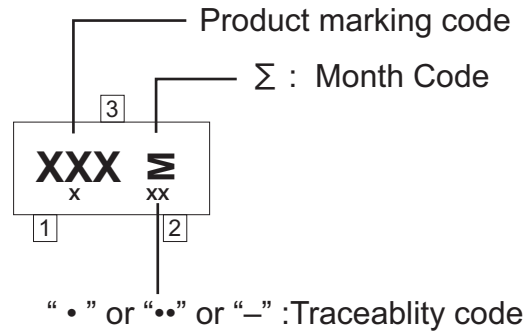

Month Code:

Month	Odd Year (per A.D.)	Even Year (per A.D.)
Jan	1	E
Feb	2	F
Wer	3	H
Apr	4	J
May	5	K
Jun	6	L

Month	Odd Year (per A.D.)	Even Year (per A.D.)
Jul	7	N
Aug	8	P
Sep	9	U
Oct	T	X
Nov	V	Y
Dec	C	Z

Suggested PAD Layout

SIZE	SOT-23	
	(mm)	(inch)
A	0.80	0.031
B	1.90	0.075
C	2.02	0.080
D	2.82	0.111
E	0.80	0.031

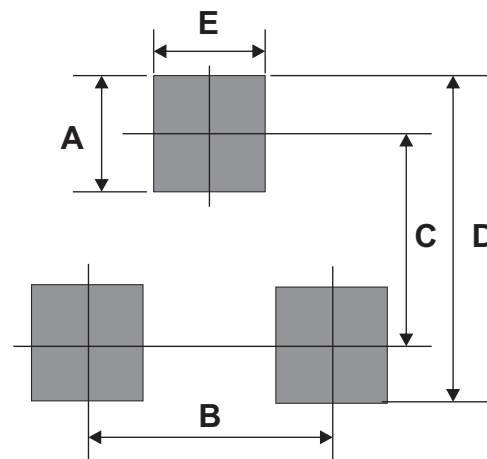

Standard Packaging

Case Type	REEL PACK	
	REEL (pcs)	Reel Size (inch)
SOT-23	3,000	7