

Blower

Cooling fan specialized for high static pressure

Domain Diagram

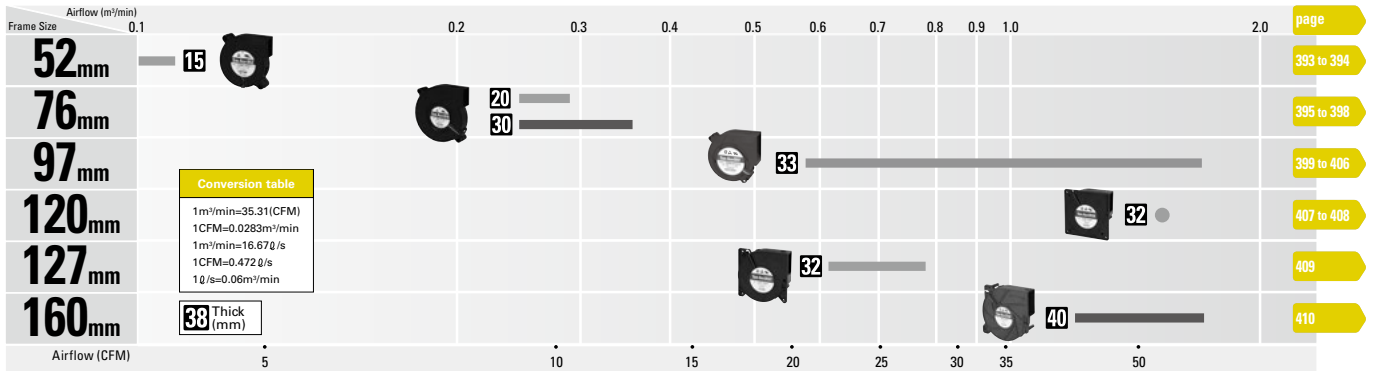

Model Numbering System

Not every combination of the following codes or characters is available. Contact us for an available combination.

109B	C	12	H	C	2	-1
Type name / frame material 109B / Plastics 9B / Plastics	Frame size C : 52mm F : 120mm D : 76mm J : 127mm M : 97mm G : 160mm	Voltage 12 : 12V 24 : 24V etc	Speed code F,G,H,K,M,S etc	Sensor specifications A : Without a sensor C : With a pulse sensor D : With a lock sensor	Frame thickness 1 : 40mm thick 2 : 30mm thick, 32mm thick, 33mm thick 7 : 15mm thick 6 : 20mm thick	Individual customer's spec

9B	MB	12	G	2	01	-1
Type name / frame material 9B / Plastics	Frame size MB : 97mm FB : 120mm	Voltage 12 : 12V 24 : 24V	Speed code G / S / H etc	Frame thickness 2 : 32mm thick / 33mm thick	Sensor specifications 01 : With a pulse sensor 02 : Without a sensor	Individual customer's spec

Fans with PWM control function

Example :

9B	MB	12	P	2	G	01
Type name / frame material 9B / Plastics	Frame size MB : 97mm FB : 120mm	Voltage 12 : 12V	PWM control function	Frame thickness 2 : 32mm thick / 33mm thick	Speed code	Individual customer's spec 2 or 3 digits

How to Read Specifications

DC Fan											DC	
Model No.	① Rated Voltage [V]	② Operating Voltage Range [V]	③ Rated Current [A]	④ Rated Input [W]	⑤ Rated Speed [min ⁻¹]	⑥ Max. Airflow [m ³ /min] [CFM]		⑦ Max. Static Pressure [Pa] [inchH ₂ O]		⑧ SPL [dB(A)]	⑨ Operating Temperature [°C]	⑩ Expected Life [h]
9GA0412G7001	12	7 to 13.8	0.17	2.04	13,100	0.36	12.7	192	0.77	42	-20 to +70	40,000/60°C (70,000/40°C)

- ① Rated Voltage This is the necessary voltage to drive the fan. 12VDC, 24VDC and 48VDC are available.
- ② Operating Voltage Range... The voltage range over which fan operation is guaranteed
- ③ Rated Current The current value during the fan's rated operation without load
- ④ Rated Input The input value during the fan's rated operation without load
- ⑤ Rated Speed The rotating speed during the fan's rated operation without load
- ⑥ Max. Airflow The maximum air volume that the fan can output during rated operation (according to the company's dual-chamber device).
The volume of air generated by the fan in a given time period
- ⑦ Max. Static Pressure The maximum static pressure value that the fan can output during rated operation (according to the company's dual-chamber device). The static pressure is the fan's force to propel air by overcoming the resistance of the device that uses the fan when it propels air.
- ⑧ SPL "SPL" is Sound Pressure Level. The noise level during the fan's rated operation.
Please refer to the technical material section for the method used to measure the noise level.
- ⑨ Operating Temperature The temperature range over which fan operation is guaranteed (Non- condensing)
- ⑩ Expected Life The fan's expected operating life when the fan operates continuously at the rated voltage at a temperature of 60°C and at relative humidity of 90%. Expected life at 40°C ambient is just reference value.
Please refer to the technical material section for the expected operating life.

DC Fan Common Specifications

Material Frame,Impeller:Plastics / Frame:Aluminum,Impeller:Plastics

* For details, refer to the appropriate page.

Expected Life Varies for each model (L10:Survival rate:90% at 60°C ,rated voltage, and continuously run in a free air state)

* Splash proof fan: Varies for each model (Indoor, L10:Survival rate:90% at 60°C ,rated voltage, and continuously run in a free air state)

Motor Protection Burnout protection at locked rotor condition and Reverse polarity protection

Dielectric Strength AC50/60Hz 500VAC 1minute(between lead conductor and frame)

Insulation Resistance 10M Ω or more at 500VDC megger (between lead conductor and frame)

Sound Pressure Level(SPL) .. Expressed as the value at 1m from air inlet side

Lead Wire For details, refer to the appropriate page.

Overheating protection function

Protection Functions:

If the fan blades are restricted, an overcurrent occurs and leads to a rise in the fan coil temperature. This can result in reduced performance, damage, or a fire. To prevent this from occurring, SANYO DENKI's fans incorporate an overheating protection function. Refer to the catalog for the types of protection functions.

Burnout protection function at locked rotor condition

- Current cutoff system

If the fan blades are restricted, the coil current is cut off at regular cycles to prevent overheating of the coil. When the hindrance is removed, the fan restarts automatically.

Reverse polarity protection function

No problem about fan even if positive & negative lead are connected in reverse.

However, when wiring fans with sensors or PWM speed control function, connecting positive and negative leads in reverse may damage the fans.

52mm**San Ace B52****General Specifications**

- Material Frame: Plastics (Flammability: UL94V-0),
Impeller: Plastics (Flammability: UL94V-0)
- Expected Life Refer to specifications (L10:Survival rate: 90% at 60°C ,
rated voltage, and continuously run in a free air state)
- Lead Wire ⊕red ⊖black (Sensor) yellow
- Storage Temperature -30°C to +70°C (Non-condensing)

52mm × 15mm [Mass : 33g] **9BC type****Specifications** The following nos. **have pulse sensors.**

Model No.	Rated Voltage [V]	Operating Voltage Range [V]	Rated Current [A]	Rated Input [W]	Rated Speed [min ⁻¹]	Max. Airflow [m ³ /min] [CFM]	Max. Static Pressure [Pa] [inchH ₂ O]	SPL [dB(A)]	Operating Temperature [°C]	Expected Life [h]
109BC12GC7-1	12	6 to 13.8	0.12	1.44	6,200	0.125 4.4	215 0.86	43	-20 to +70	40,000/60°C (70,000/40°C)
109BC12HC7-1			0.10	1.20	5,600	0.112 4.0	165 0.66	40		
109BC12FC7-1			0.08	0.96	5,100	0.101 3.6	130 0.52	38		
109BC12MC7-1			0.06	0.72	4,600	0.091 3.2	100 0.40	35		
109BC24GC7-1	24	12 to 27.6	0.07	1.68	6,200	0.125 4.4	215 0.86	43		
109BC24HC7-1			0.05	1.20	5,600	0.112 4.0	165 0.66	40		
109BC24FC7-1			0.04	0.96	5,100	0.101 3.6	130 0.52	38		

Other sensor specifications are available as options. Please refer to the index (p. 495).

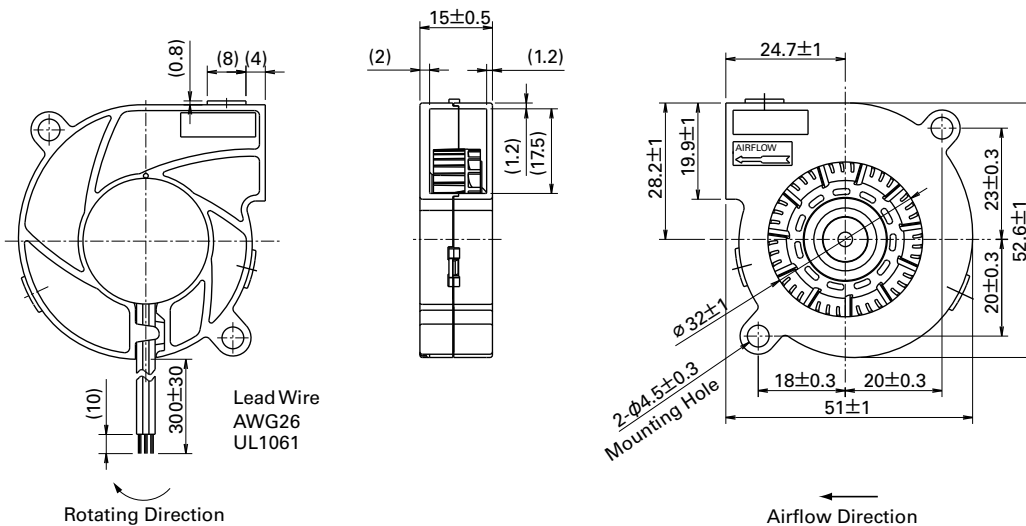
Dimensions (unit: mm)

Airflow - Static Pressure Characteristics

G speed

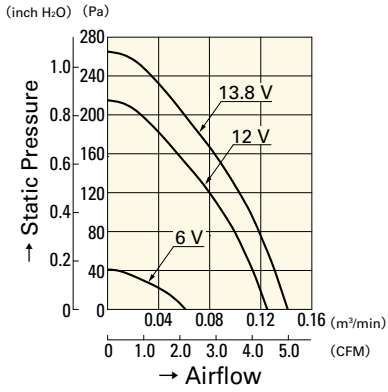

109BC12GC7-1

H speed

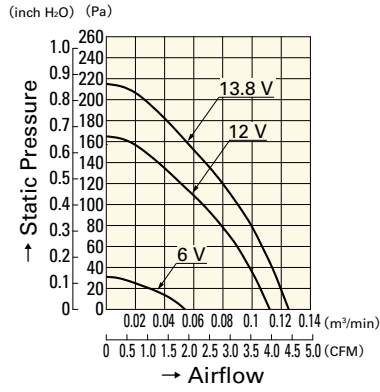

109BC12HC7-1

F speed

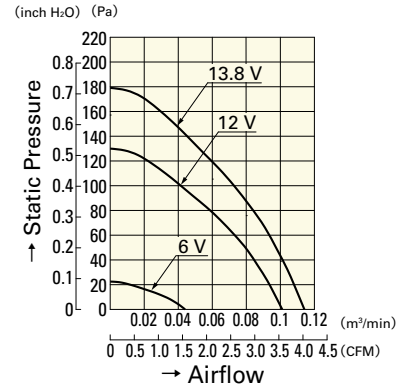

109BC12FC7-1

M speed

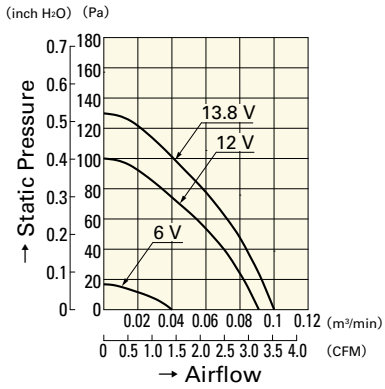

109BC12MC7-1

G speed

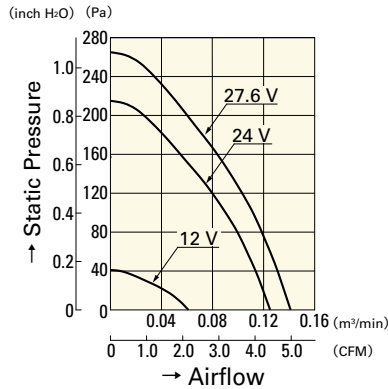

109BC24GC7-1

H speed

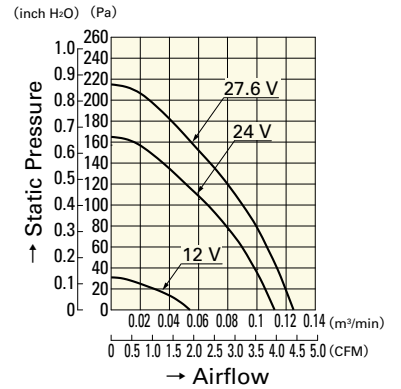

109BC24HC7-1

F speed

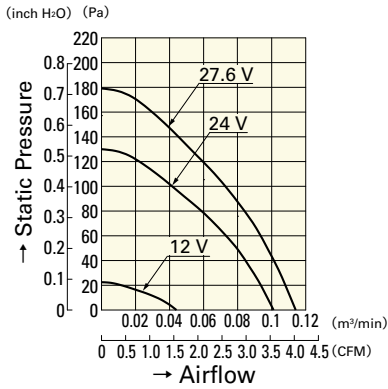

109BC24FC7-1

DC

Blower 52mm

76mm**San Ace B76****General Specifications**

- Material Frame: Plastics (Flammability: UL94V-0),
Impeller: Plastics (Flammability: UL94V-0)
- Expected Life Refer to specifications (L10:Survival rate: 90% at 60°C ,
rated voltage, and continuously run in a free air state)
- Lead Wire ⊕red ⊖black (Sensor) yellow
- Storage Temperature -30°C to +70°C (Non-condensing)

76mm×20mm [Mass : 58g] **9BD type****Specifications** The following nos. **have pulse sensors.**

Model No.	Rated Voltage [V]	Operating Voltage Range [V]	Rated Current [A]	Rated Input [W]	Rated Speed [min ⁻¹]	Max. Airflow [m ³ /min] [CFM]	Max. Static Pressure [Pa] [inchH ₂ O]	SPL [dB(A)]	Operating Temperature [°C]	Expected Life [h]
9BD12SC6-1	12	5 to 13.8	0.28	3.36	4,500	0.29 10.2	300 1.20	43	-20 to +70	40,000/60°C (70,000/40°C)
9BD12HC6-1			0.21	2.52	4,200	0.27 9.5	230 0.92	41		
9BD12FC6-1		0.18	2.16	3,900	0.25 8.8	200 0.80	39			
9BD24SC6-1	24	10 to 27.6	0.14	3.36	4,500	0.29 10.2	300 1.20	43		
9BD24HC6-1			0.12	2.88	4,200	0.27 9.5	230 0.92	41		
9BD24FC6-1			0.10	2.4	3,900	0.25 8.8	200 0.80	39		

Other sensor specifications are available as options. Please refer to the index (p. 500).

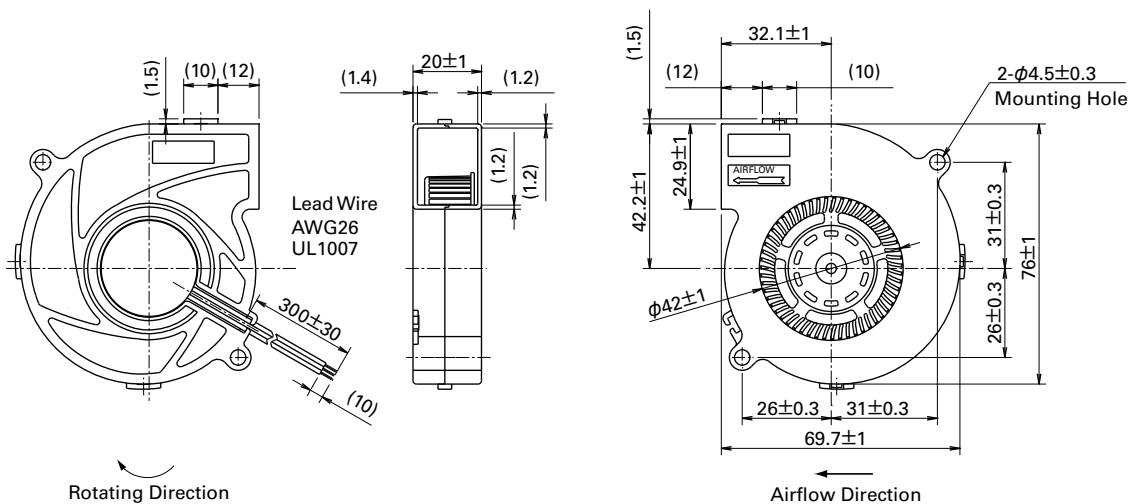
Dimensions (unit: mm)

Airflow - Static Pressure Characteristics

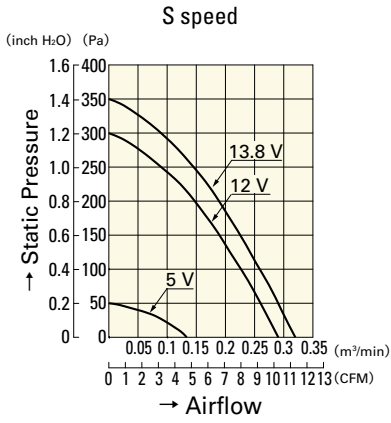

9BD12SC6-1

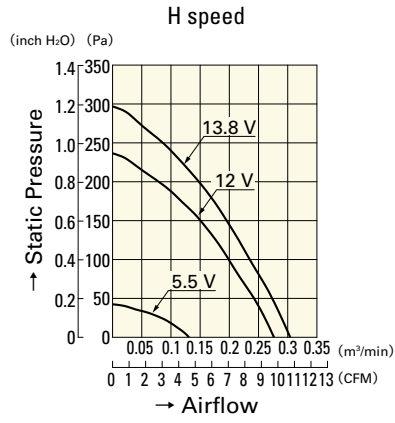

9BD12HC6-1

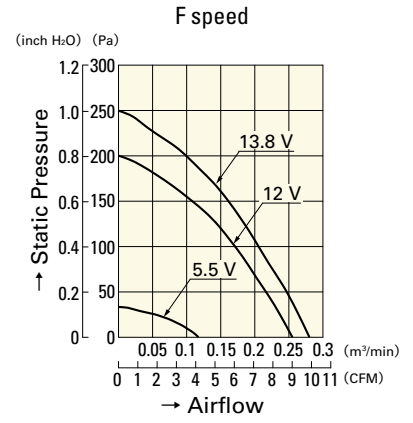

9BD12FC6-1

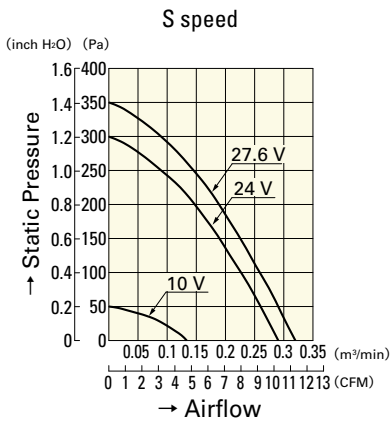

9BD24SC6-1

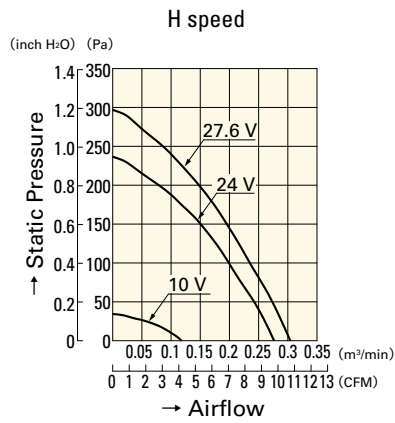

9BD24HC6-1

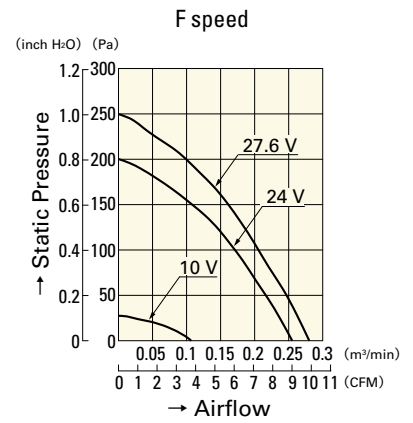

9BD24FC6-1

76mm**San Ace B76****General Specifications**

- Material Frame: Plastics (Flammability: UL94V-0),
Impeller: Plastics (Flammability: UL94V-1)
- Expected Life Refer to specifications (L10:Survival rate: 90% at 60°C,
rated voltage, and continuously run in a free air state)
- Lead Wire ⊕red ⊖black or blue (Sensor) yellow
- Storage Temperature -30°C to +70°C (Non-condensing)

76mm×30mm (Mass : 100g) **9BD type****Specifications** The following nos. **have pulse sensors.**

Model No.	Rated Voltage [V]	Operating Voltage Range [V]	Rated Current [A]	Rated Input [W]	Rated Speed [min ⁻¹]	Max. Airflow [m ³ /min] [CFM]	Max. Static Pressure [Pa] [inchH ₂ O]	SPL [dB(A)]	Operating Temperature [°C]	Expected Life [h]
109BD12HC2	12	10.2 to 13.8	0.37	4.44	3,000	0.36 12.7	151.9 0.610	41.5	-20 to +60	40,000/60°C
109BD12FC2			0.27	3.24	2,600	0.31 10.9	98 0.394	37		
109BD12MC2			0.14	1.68	2,100	0.25 8.8	58.8 0.236	32.5		
109BD24HC2	24	20.4 to 27.6	0.17	4.08	3,000	0.36 12.7	151.9 0.610	41.5	-20 to +60	
109BD24FC2			0.14	3.36	2,600	0.31 10.9	98 0.394	37	-20 to +70	
109BD24MC2			0.10	2.40	2,100	0.25 8.8	58.8 0.236	32.5	-20 to +70	

Other sensor specifications are available as options. Please refer to the index (p. 495).

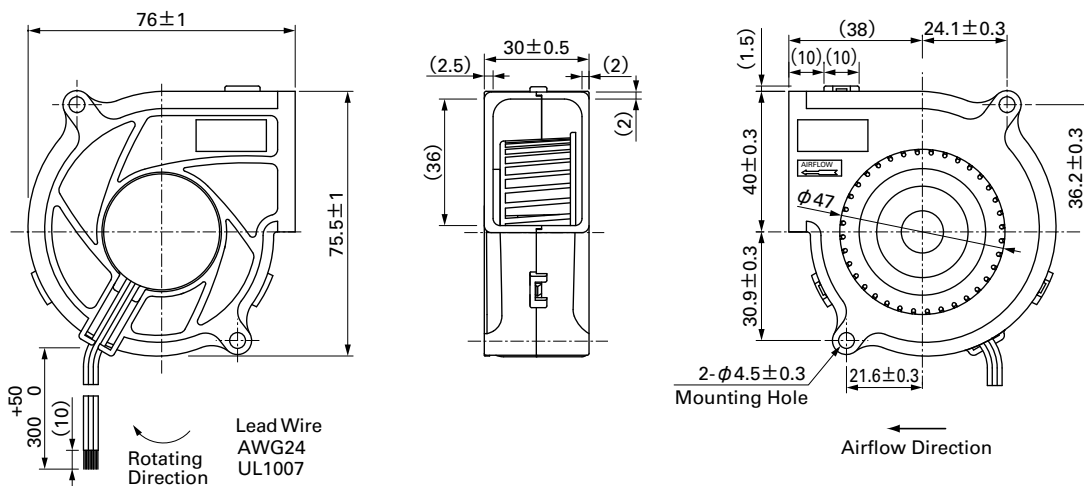
Dimensions (unit: mm)

Airflow - Static Pressure Characteristics

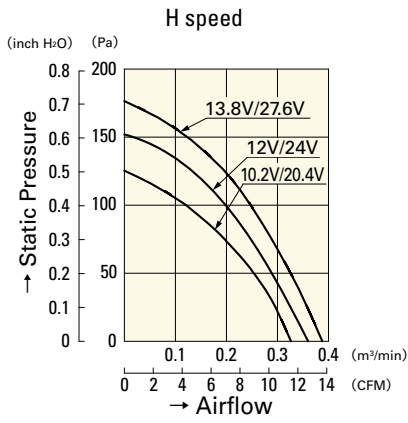

109BD12HC2
109BD24HC2

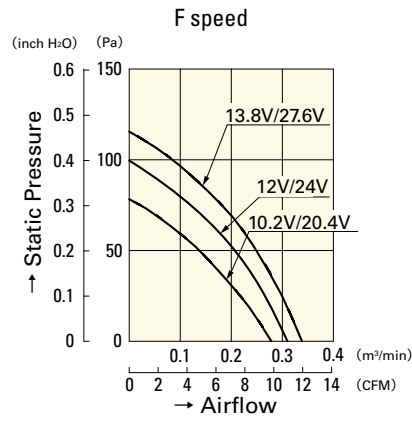

109BD12FC2
109BD24FC2

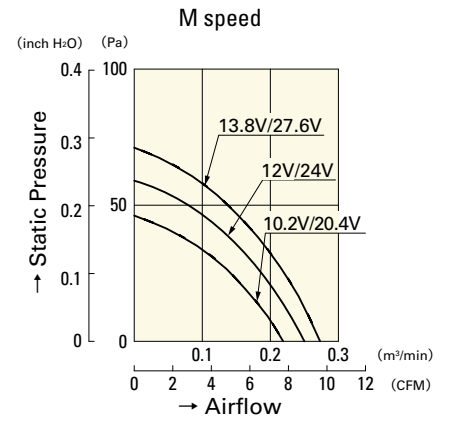

109BD12MC2
109BD24MC2

97 mm

San Ace B97



General Specifications

- Material..... Frame: Plastics (Flammability: UL94V-0),
Impeller: Plastics (Flammability: UL94V-0)
- Expected Life Refer to specifications (L10:Survival rate: 90% at 60°C ,
rated voltage, and continuously run in a free air state)
- Lead Wire ⊕red ⊖black (Sensor) yellow
- Storage Temperature -30°C to +70°C (Non-condensing)

97 mm × 33 mm (Mass : 175g) **9BM type**Specifications The following nos. **have pulse sensors.**

Model No.	Rated Voltage [V]	Operating Voltage Range [V]	Rated Current [A]	Rated Input [W]	Rated Speed [min ⁻¹]	Max. Airflow [m ³ /min] [CFM]	Max. Static Pressure [Pa] [inchH ₂ O]	SPL [dB(A)]	Operating Temperature [°C]	Expected Life [h]
109BM12GC2-1	12	7 to 13.8	0.60	7.20	3,800	0.82 28.9	281 1.129	51.5	-20 to +70	40,000/60°C (70,000/40°C)
109BM12HC2-1			0.40	4.80	3,300	0.71 25.1	204 0.819	48.5		
109BM12MC2-1			0.26	3.12	2,700	0.58 20.5	119 0.478	43.5		
109BM24GC2-1	24	12 to 27.6	0.31	7.44	3,800	0.82 28.9	281 1.129	51.5		
109BM24HC2-1			0.26	6.24	3,300	0.71 25.1	204 0.819	48.5		
109BM24MC2-1			0.15	3.60	2,700	0.58 20.5	119 0.478	43.5		

Other sensor specifications are available as options. Please refer to the index (p. 495).

Dimensions (unit: mm)

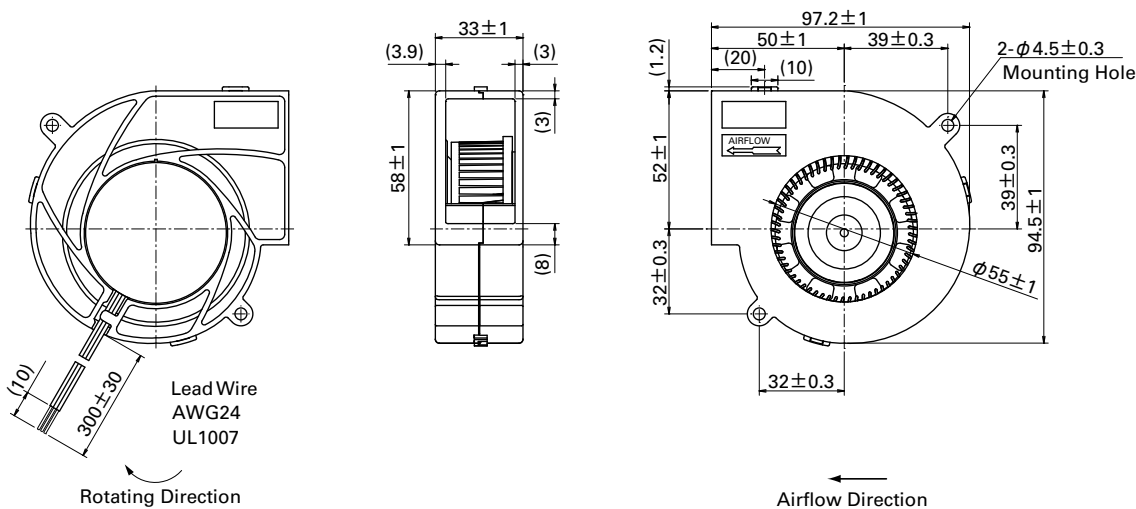

Airflow - Static Pressure Characteristics

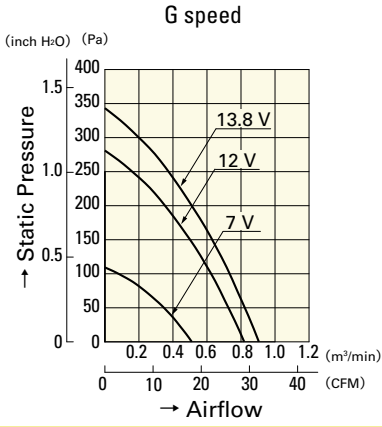

109BM12GC2-1

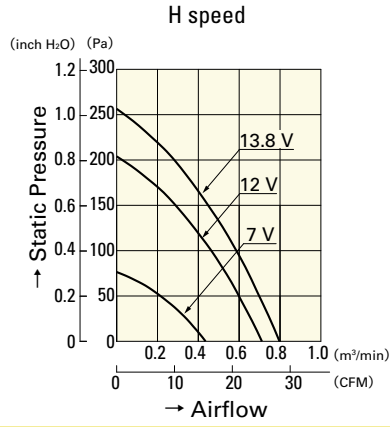

109BM12HC2-1

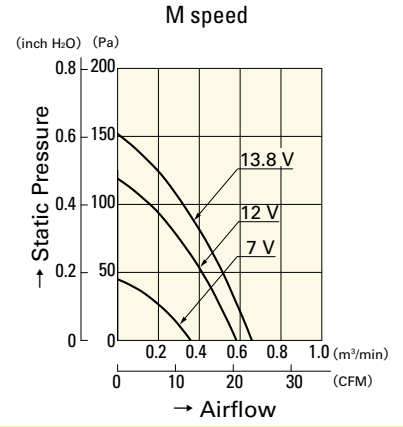

109BM12MC2-1

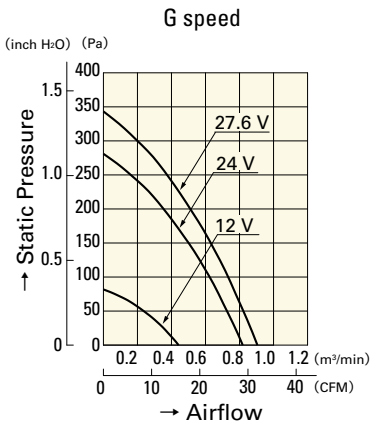

109BM24GC2-1

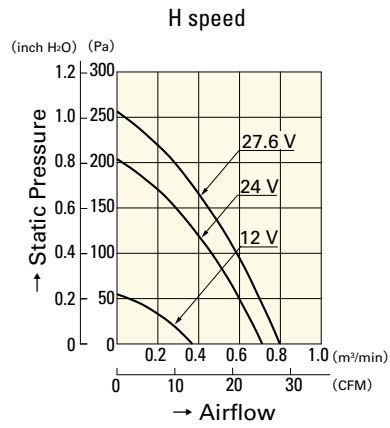

109BM24HC2-1

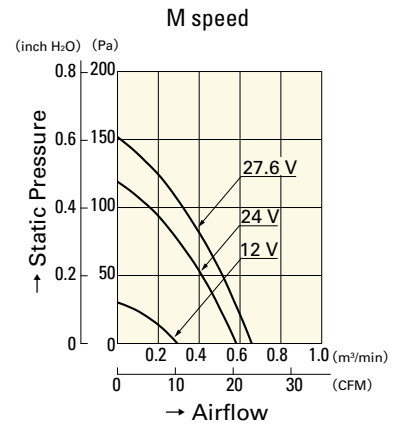

109BM24MC2-1

DC

Blower 97mm

97 mm

San Ace B97



General Specifications

- Material Frame: Plastics (Flammability: UL94V-0),
Impeller: Plastics (Flammability: UL94V-0)
- Expected Life Refer to specifications (L10:Survival rate: 90% at 60°C,
rated voltage, and continuously run in a free air state)
- Lead Wire ⊕red ⊖black (Sensor) yellow (Control) brown
(For models without PWM control function, there is no speed control wiring.)
- Storage Temperature ... -30°C to +70°C (Non-condensing)

97 mm × 33 mm (Mass : 190g) **9BMB type**

Specifications The following nos. have PWM controls and pulse sensors.

Model No.	Rated Voltage [V]	Operating Voltage Range [V]	PWM duty cycle ^{Note1)} [%]	Rated Current [A]	Rated Input [W]	Rated Speed [min ⁻¹]	Max. Airflow [m ³ /min] [CFM]	Max. Static Pressure [Pa] [inchH ₂ O]	SPL [dB(A)]	Operating Temperature [°C]	Expected Life [h]
9BMB12P2K01	12	10.8 to 13.2	100	3.4	40.8	6,850	1.61 56.8	1,280 5.14	66	-20 to +70	40,000/60°C
9BMB12P2G01			100	1.8	21.6	5,750	1.34 47.3	760 3.050	61		
9BMB12P2S01		10.2 to 13.8	100	1.4	16.8	5,250	1.22 43.1	610 2.450	59		
9BMB12P2H01			100	1.1	13.2	4,850	1.11 39.2	490 1.968	57		
9BMB12P2F01			100	0.9	10.8	4,500	1.04 36.7	410 1.64	56		
9BMB24P2K01	24	21.6 to 26.4	100	1.62	38.88	6,850	1.61 56.8	1,280 5.14	66		
9BMB24P2G01			100	0.83	19.92	5,750	1.34 47.3	760 3.05	61		
9BMB24P2S01			100	0.7	16.8	5,250	1.22 43.1	610 2.450	59		
9BMB24P2H01			100	0.55	13.2	4,850	1.11 39.2	490 1.968	57		
9BMB24P2F01			100	0.45	10.8	4,500	1.04 36.7	410 1.640	56		

Note: Fan does not rotate when PWM duty cycle is 0%.

※PWM Frequency : 25kHz

The following nos. have pulse sensors.

Model No.	Rated Voltage [V]	Operating Voltage Range [V]	Rated Current [A]	Rated Input [W]	Rated Speed [min ⁻¹]	Max. Airflow [m ³ /min] [CFM]	Max. Static Pressure [Pa] [inchH ₂ O]	SPL [dB(A)]	Operating Temperature [°C]	Expected Life [h]
9BMB12K201	12	7 to 13.2	3.4	40.8	6,850	1.61 56.8	1,280 5.14	66	-20 to +70	40,000/60°C
9BMB12G201			1.80	21.6	5,750	1.34 47.3	760 3.052	61		
9BMB12S201			1.40	16.8	5,250	1.22 43.1	610 2.450	59		
9BMB12H201			1.10	13.2	4,850	1.11 39.2	490 1.968	57		
9BMB12F201			0.90	10.8	4,500	1.04 36.7	410 1.647	56		
9BMB24K201	24	12 to 26.4	1.62	38.88	6,850	1.61 56.8	1,280 5.14	66		
9BMB24G201			0.83	19.9	5,750	1.34 47.3	760 3.052	61		
9BMB24S201			0.70	16.8	5,250	1.22 43.1	610 2.450	59		
9BMB24H201			0.55	13.2	4,850	1.11 39.2	490 1.968	57		
9BMB24F201			0.45	10.8	4,500	1.04 36.7	410 1.647	56		

Other sensor specifications are available as options. Please refer to the index (p. 501).

Dimensions (unit: mm) (With PWM control function · With pulse sensor)

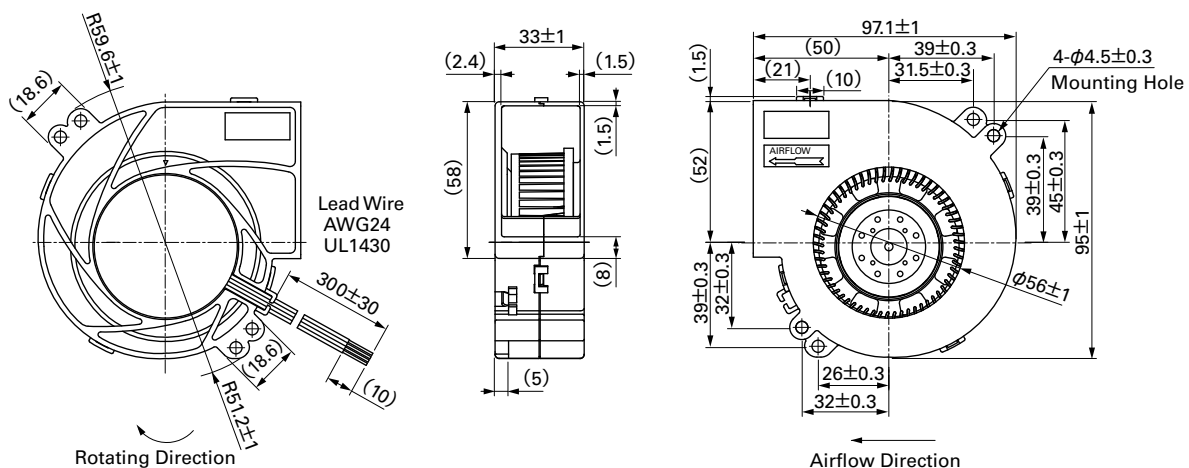

Airflow - Static Pressure Characteristics

PWM Duty - Speed Characteristics Example

PWM Duty Cycle

Operating Voltage Range

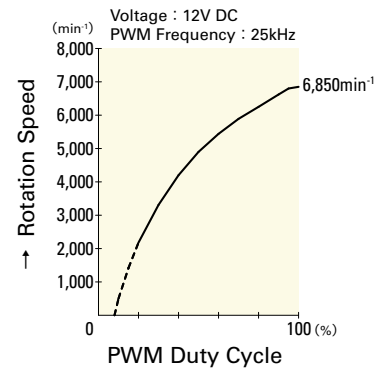
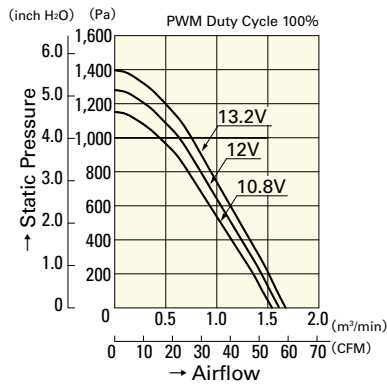
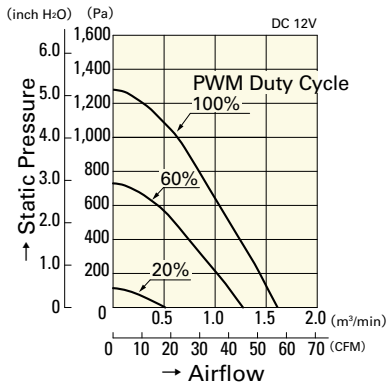

9BMB12P2K01

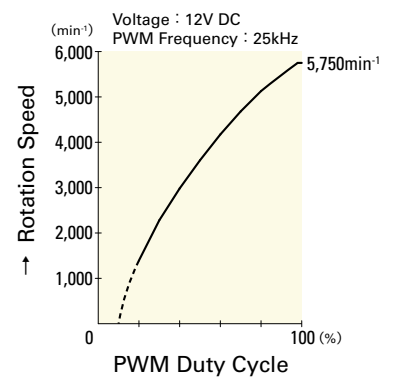
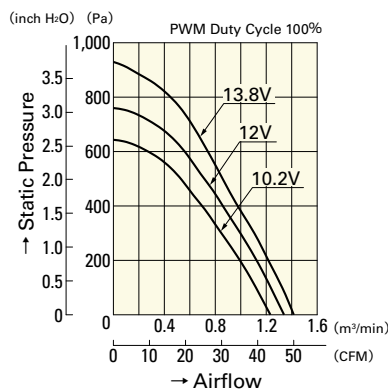
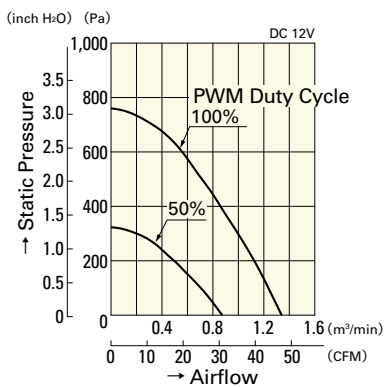

9BMB12P2G01

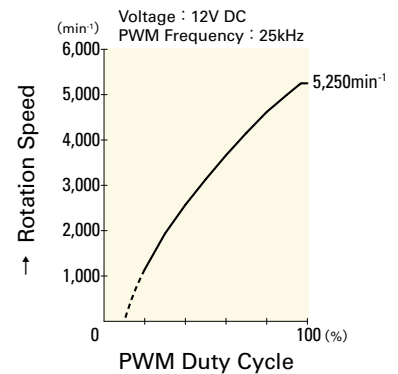
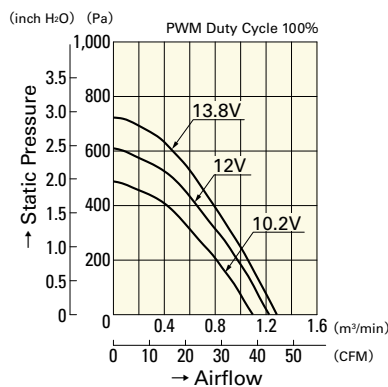
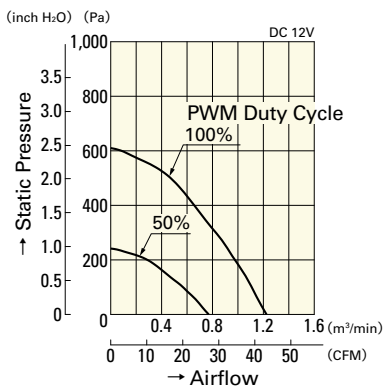

9BMB12P2S01

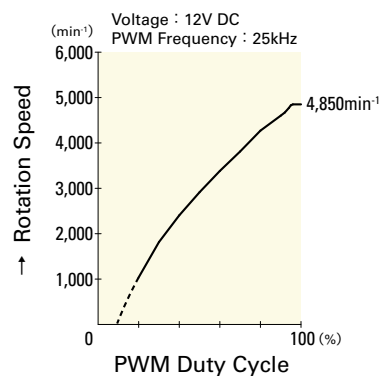
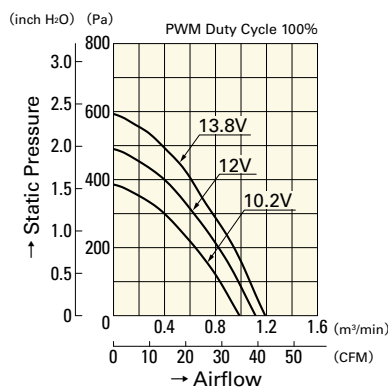
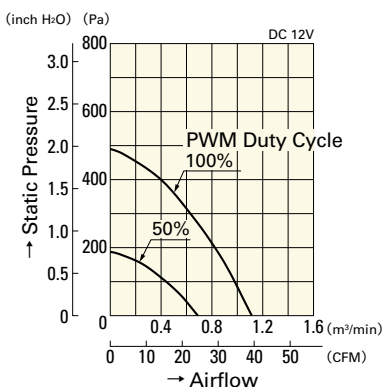

9BMB12P2H01

97mm

San Ace B97

97mm × 33mm [Mass : 190g]

Airflow - Static Pressure Characteristics

PWM Duty - Speed Characteristics Example

PWM Duty Cycle

Operating Voltage Range

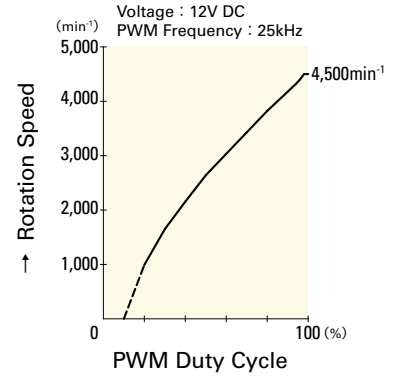
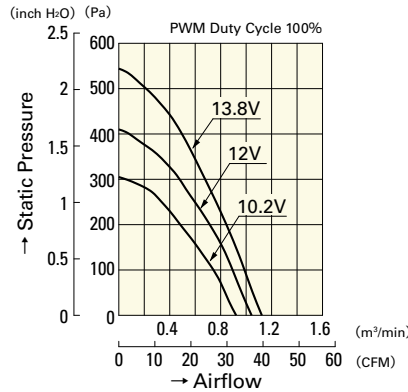
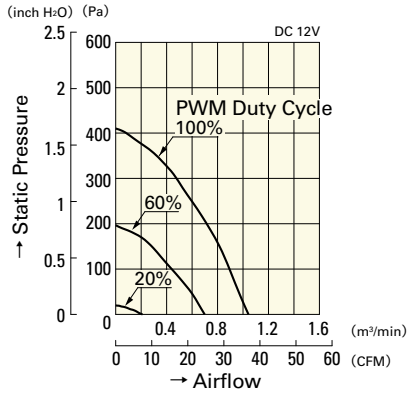

9BMB12P2F01

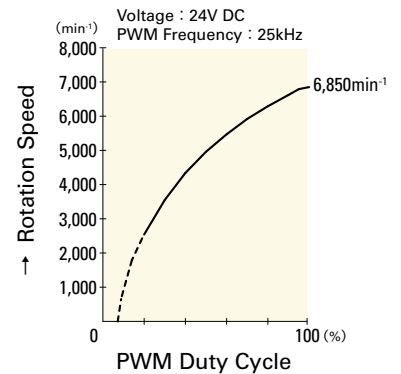
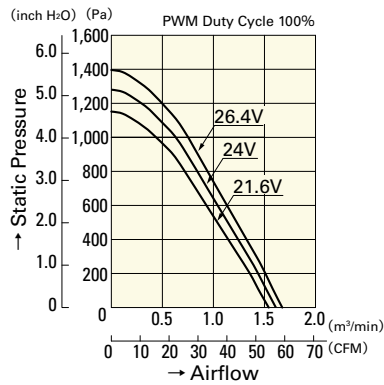
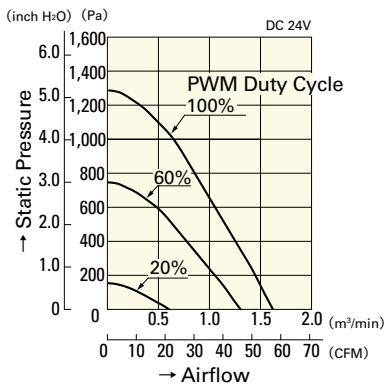

9BMB24P2K01

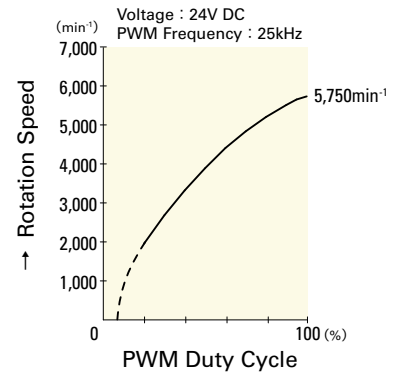
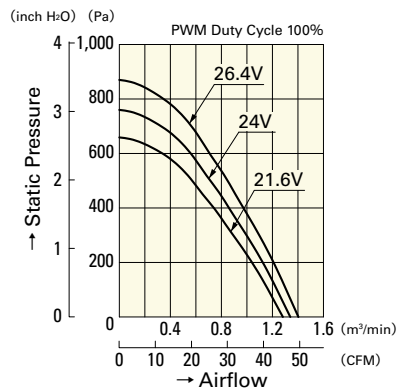
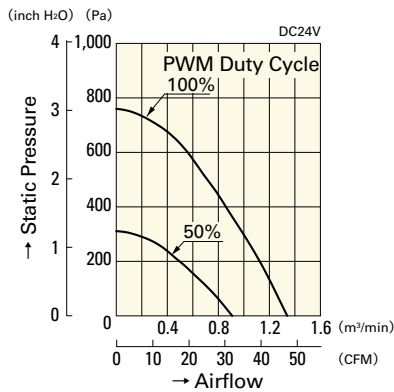

9BMB24P2G01

Airflow - Static Pressure Characteristics

PWM Duty Cycle

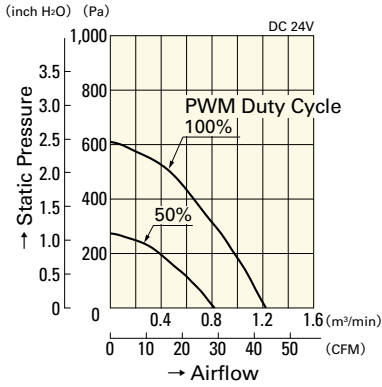

Operating Voltage Range

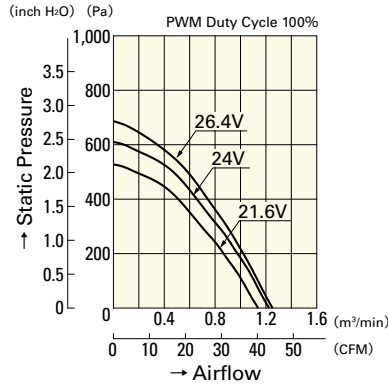

PWM Duty - Speed Characteristics Example

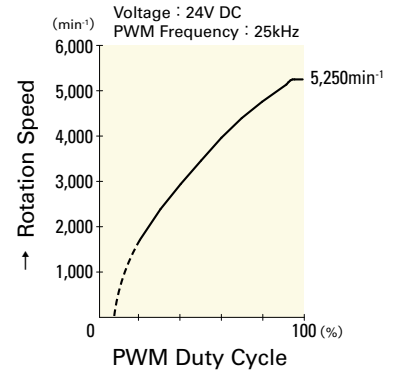

9BMB24P2S01

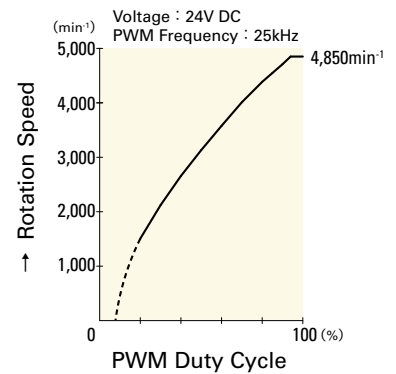
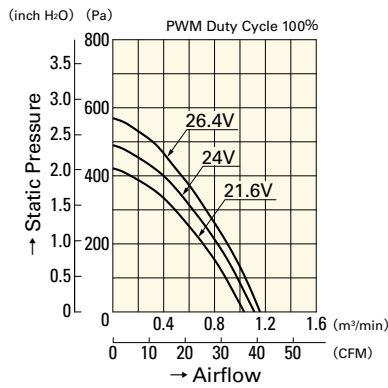
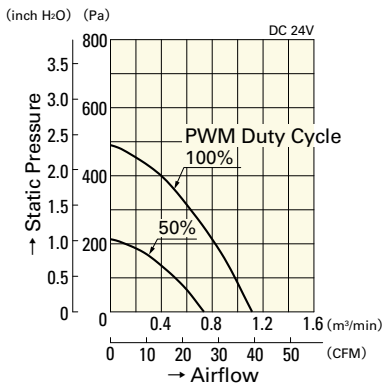

9BMB24P2H01

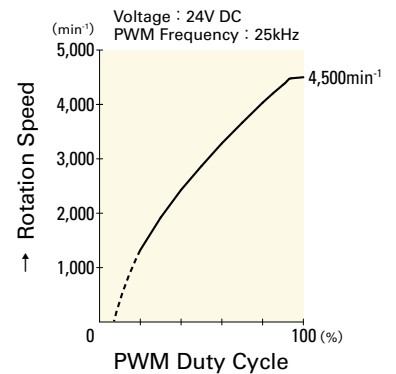
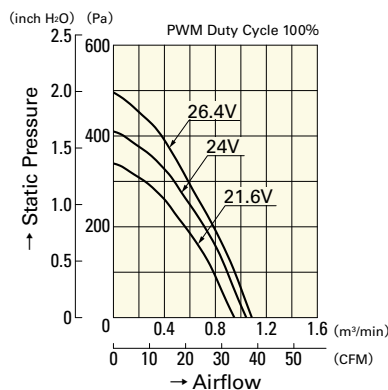
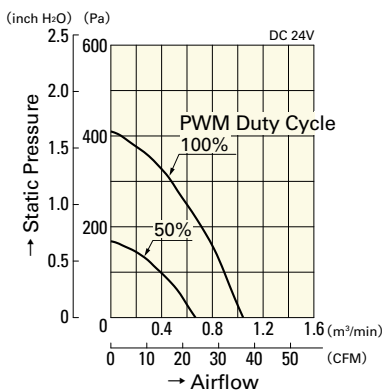

9BMB24P2F01

DC
Blower 97mm

97mm

San Ace B97

97mm × 33mm [Mass : 190g]

Airflow - Static Pressure Characteristics

Operating Voltage Range

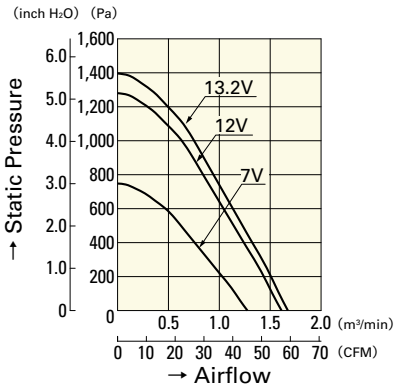

9BMB12K201

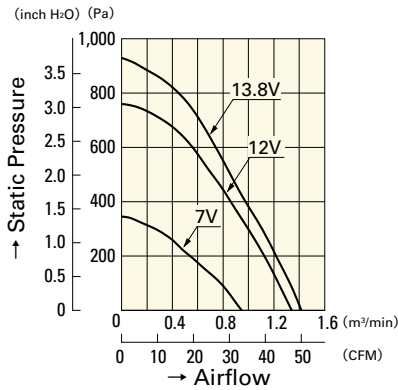

9BMB12G201

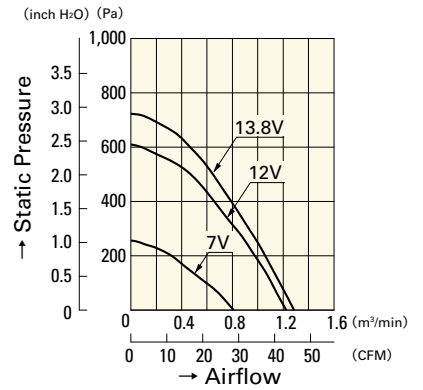

9BMB12S201

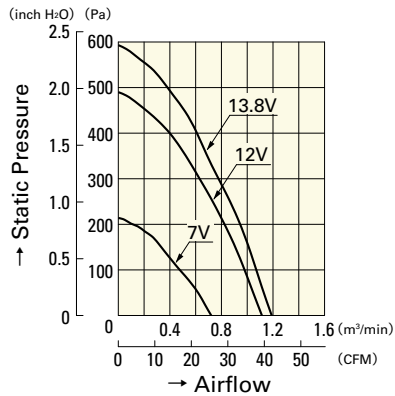

9BMB12H201

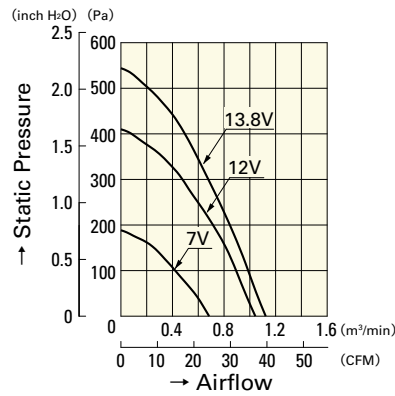

9BMB12F201

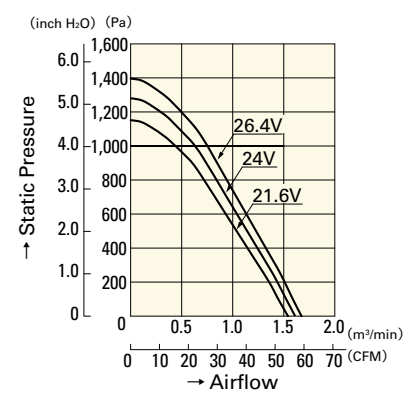

9BMB24K201

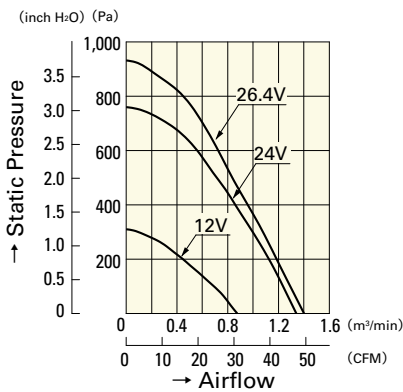

9BMB24G201

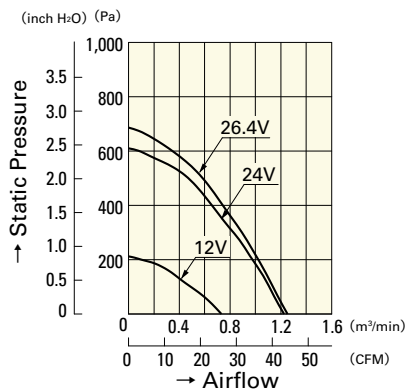

9BMB24S201

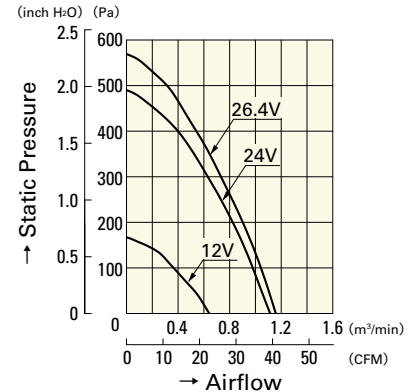

9BMB24H201

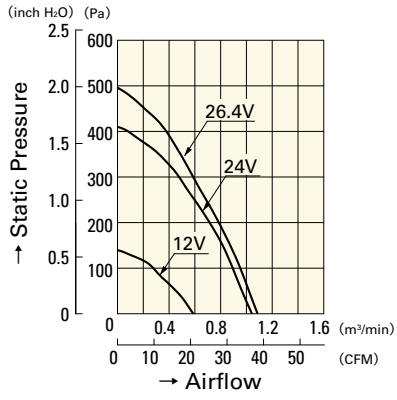

9BMB24F201

Blower 97mm DC

120mm**San Ace B120****General Specifications**

- Material Frame: Plastics (Flammability: UL94V-0),
Impeller: Plastics (Flammability: UL94V-0)
- Expected Life Refer to specifications (L10:Survival rate: 90% at 60°C ,
rated voltage, and continuously run in a free air state)
- Lead Wire ⊕red ⊖black (Sensor) yellow (Control) brown
- Storage Temperature -30°C to +70°C (Non-condensing)

120mm×32mm (Mass : 340g) **9BFB type** **Specifications** The following nos. **have PWM controls and pulse sensors.**

Model No.	Rated Voltage [V]	Operating Voltage Range [V]	PWM duty cycle* [%]	Rated Current [A]	Rated Input [W]	Rated Speed [min ⁻¹]	Max. Airflow [m ³ /min] [CFM]	Max. Static Pressure [Pa] [InchH ₂ O]	SPL [dB(A)]	Operating Temperature [°C]	Expected Life [h]
9BFB12P2H003 <small>(Note)</small>	12	10.8 to 13.2	100	2.3	27.6	3,750	1.6 56.5	1,250 5.02	62	-20 to +70	40,000/60°C (70,000/40°C)
9BFB24P2H003	24	21.6 to 26.4	100 0	1.1 0.12	26.4 2.88	3,750 1,300	1.6 56.5 0.46 16.2	1,250 5.02 43 0.17	62 41		

Note : Fan does not rotate when PWM duty cycle is 0%.

※PWM Frequency : 25kHz

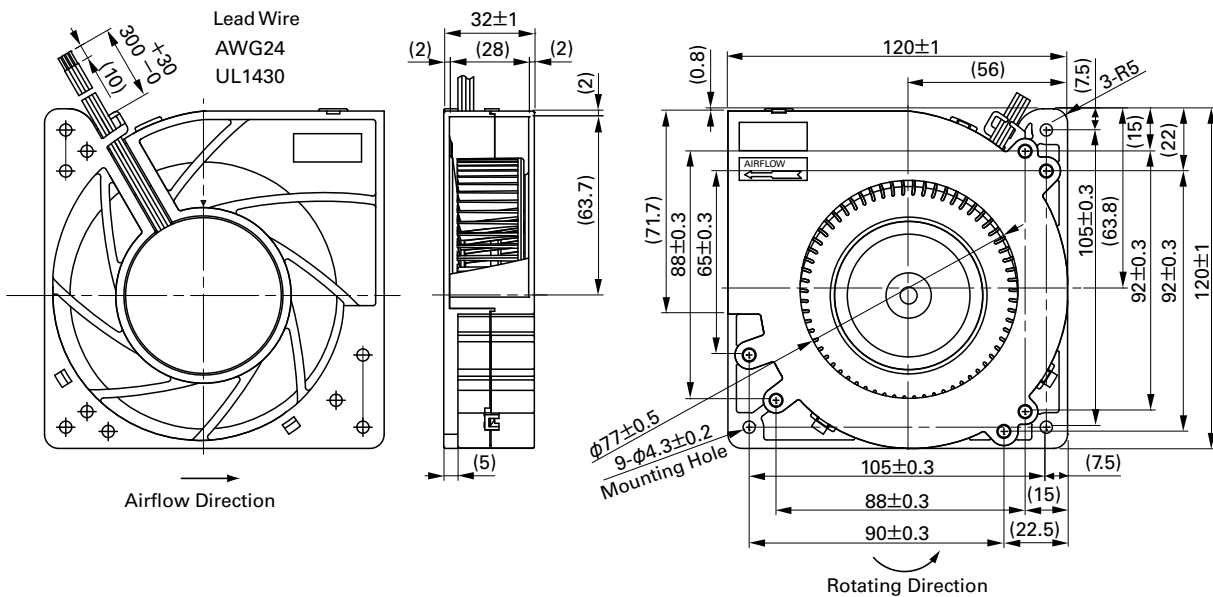
Dimensions (unit: mm)

Airflow - Static Pressure Characteristics

PWM Duty Cycle

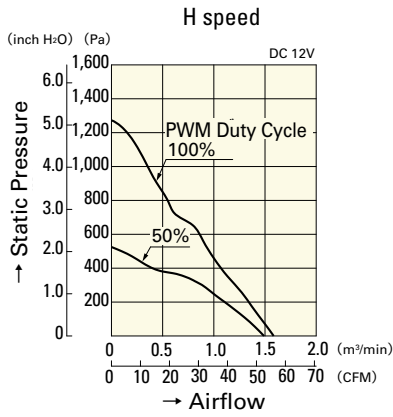

9BFB12P2H003

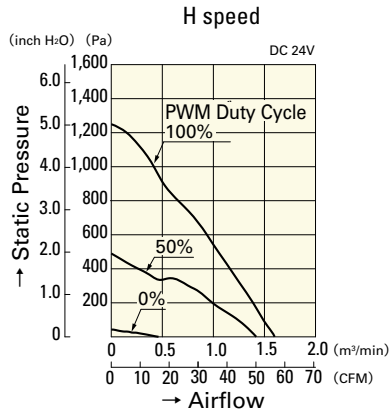

9BFB24P2H003

Operating Voltage Range

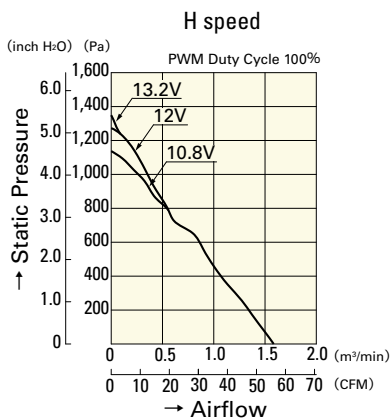

9BFB12P2H003

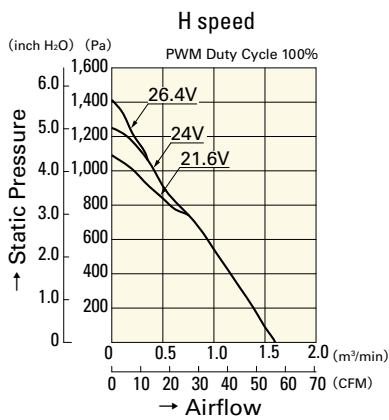

9BFB24P2H003

PWM Duty - Speed Characteristics Example

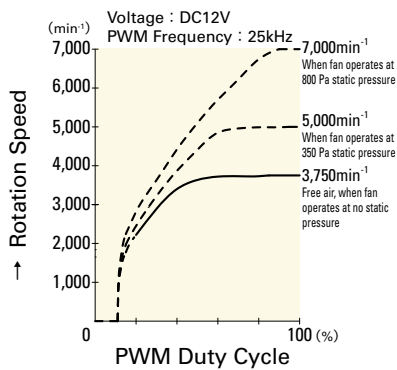

9BFB12P2H003

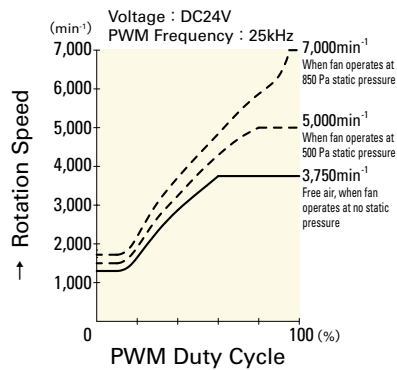

9BFB24P2H003

127mm

San Ace B127



General Specifications

- Material Frame: Plastics (Flammability: UL94V-0),
Impeller: Plastics (Flammability: UL94V-1)
- Expected Life Refer to specifications (L10:Survival rate: 90% at 60°C ,
rated voltage, and continuously run in a free air state)
- Lead Wire ⊕red ⊖black or blue (Sensor) yellow
- Storage Temperature -30°C to +70°C (Non-condensing)

127mm×32mm (Mass : 290g) **9BJ type**

Specifications

The following nos. **have pulse sensors.**

Model No.	Rated Voltage [V]	Operating Voltage Range [V]	Rated Current [A]	Rated Input [W]	Rated Speed [min ⁻¹]	Max. Airflow [m ³ /min] [CFM]	Max. Static Pressure [Pa] [inchH ₂ O]	SPL [dB(A)]	Operating Temperature [°C]	Expected Life [h]	
109BJ12HC2	12	10.2 to 13.8	0.52	6.24	2,400	0.78	27.5	205.8	0.826	46	40,000/60°C
109BJ12MC2			0.29	3.48	1,900	0.61	21.5	109.8	0.441	40	
109BJ24HC2	24	20.4 to 27.6	0.26	6.24	2,400	0.78	27.5	205.8	0.826	46	
109BJ24MC2			0.15	3.6	1,900	0.61	21.5	109.8	0.441	40	

Other sensor specifications are available as options. Please refer to the index (p. 495).

Dimensions (unit: mm)

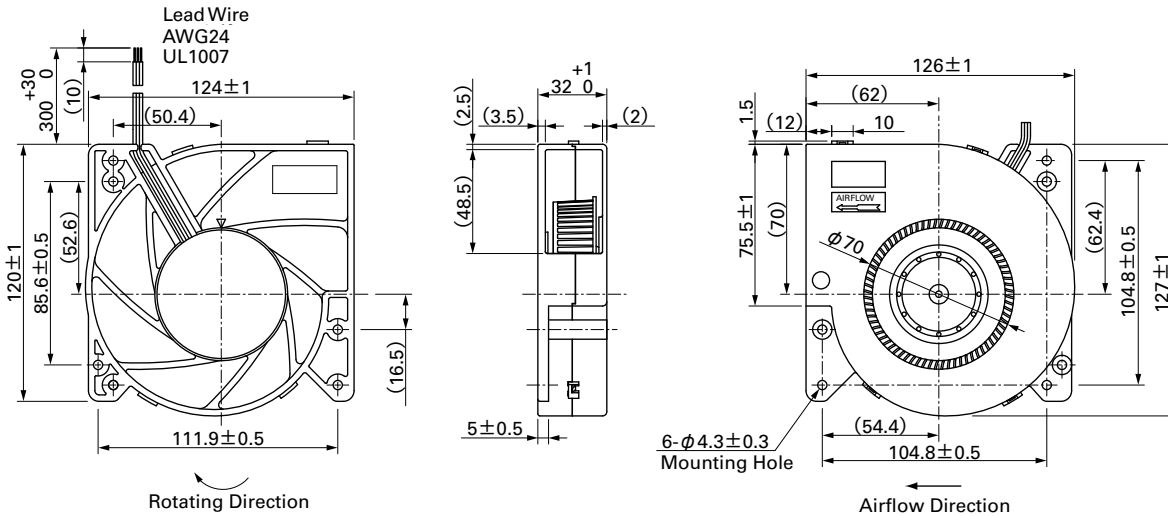

Airflow - Static Pressure Characteristics

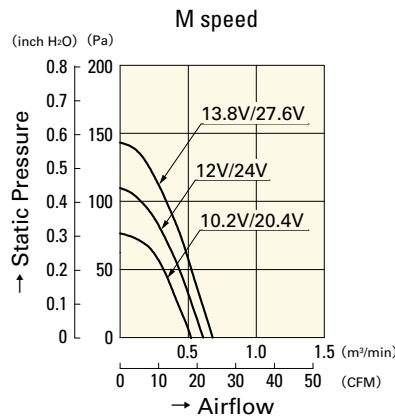
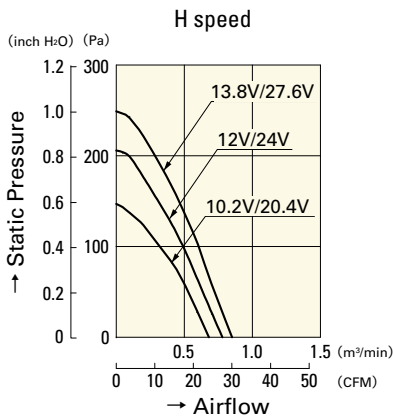

109BJ12HC2
109BJ24HC2

109BJ12MC2
109BJ24MC2

160mm

San Ace B160



General Specifications

- Material Frame: Plastics (Flammability: UL94V-0),
Impeller: Plastics (Flammability: UL94V-1)
- Expected Life Refer to specifications (L10:Survival rate: 90% at 60°C ,
rated voltage, and continuously run in a free air state)
- Lead Wire ⊕red ⊖black or blue (Sensor) yellow
- Storage Temperature -30°C to +70°C (Non-condensing)

160mm×40mm (Mass : 580g) **9BG type**

Specifications

The following nos. **have pulse sensors**.

Model No.	Rated Voltage [V]	Operating Voltage Range [V]	Rated Current [A]	Rated Input [W]	Rated Speed [min ⁻¹]	Max. Airflow [m ³ /min] [CFM]	Max. Static Pressure [Pa] [inchH ₂ O]	SPL [dB(A)]	Operating Temperature [°C]	Expected Life [h]
109BG12HC1	12	10.2 to 13.8	1.3	15.6	2,300	1.62 57.2	313.6 1.259	55	- 20 to + 60	40,000/60°C
109BG12MC1			0.64	7.68	1,800	1.26 44.5	156.8 0.629	50		
109BG24HC1	24	20.4 to 27.6	0.62	14.88	2,300	1.62 57.2	313.6 1.259	55		
109BG24MC1			0.31	7.44	1,800	1.26 44.5	156.8 0.629	50		

Other sensor specifications are available as options. Please refer to the index (p. 495).

Dimensions (unit: mm)

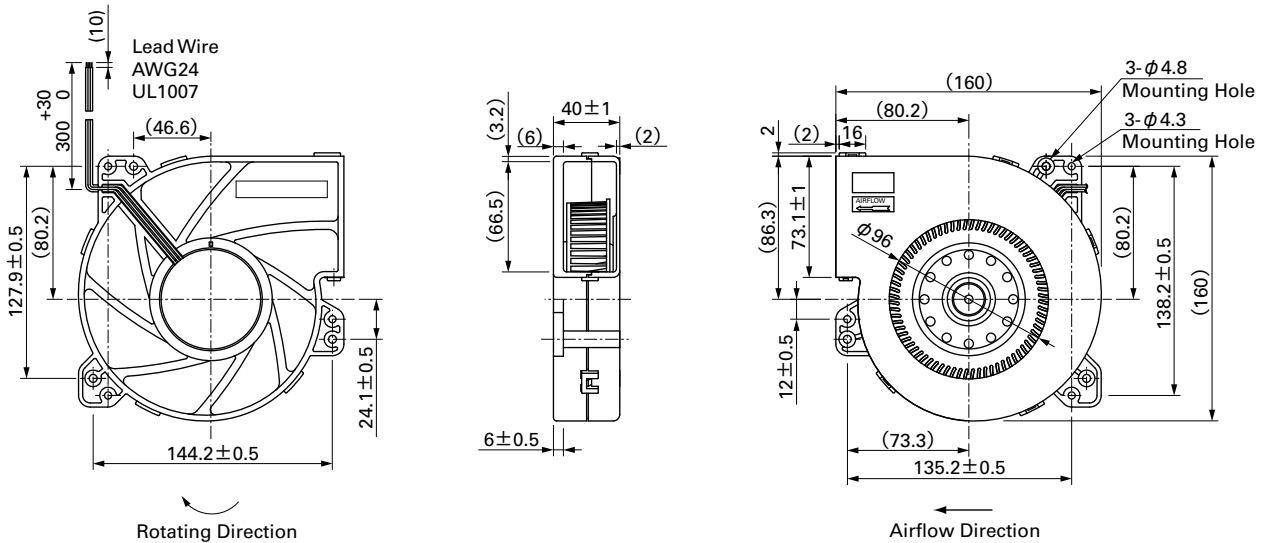

Airflow - Static Pressure Characteristics

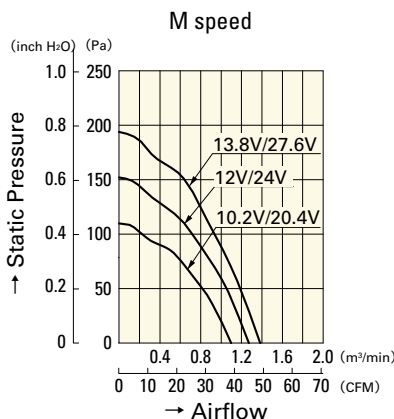
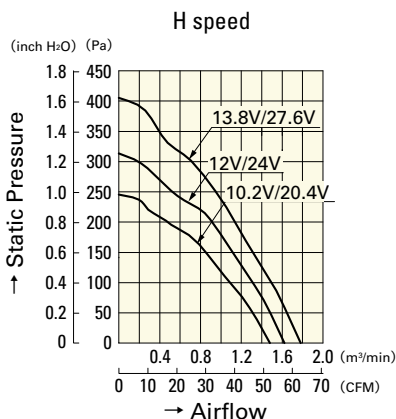

109BG12HC1
109BG24HC1

109BG12MC1
109BG24MC1