

LOC		DIST		REVISIONS			
P	LTR	DATE	DMN	APVD			
E		REVISED PER ECO-12-007492	03AUG12	KH	SM		

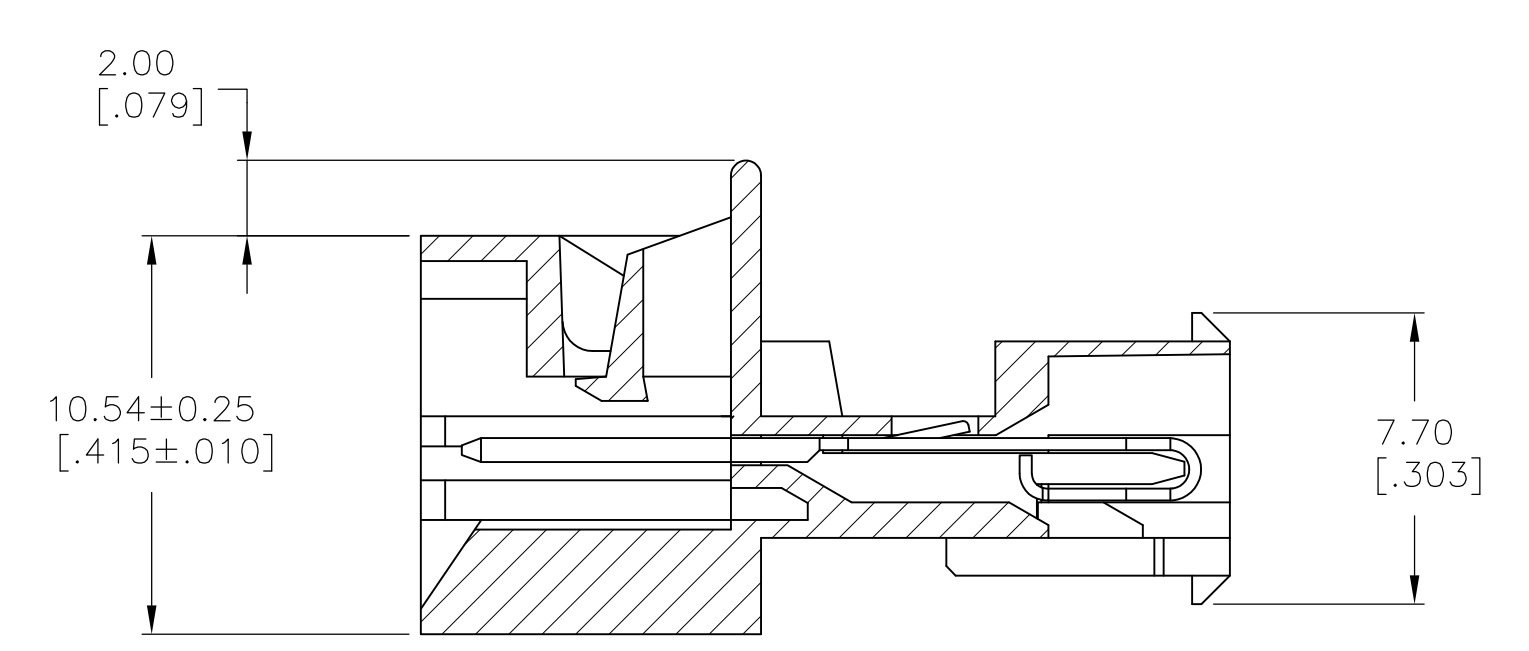

SECTION A-A

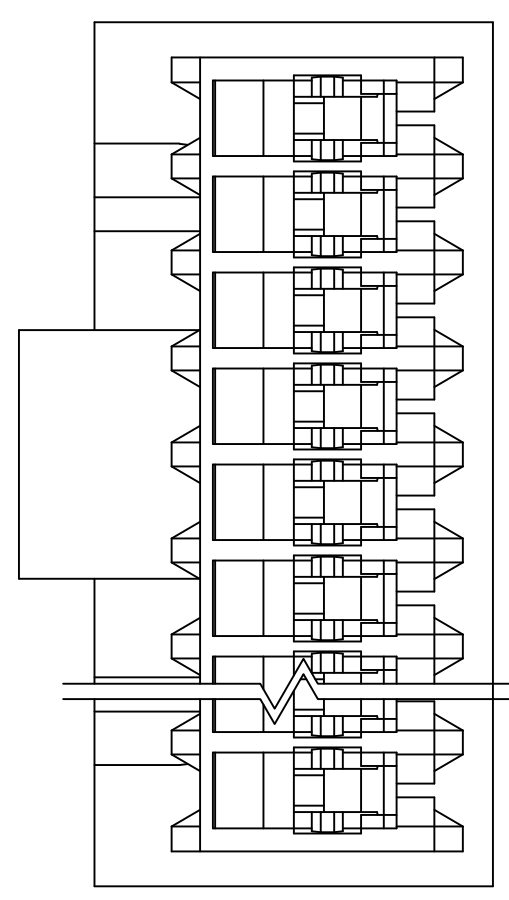
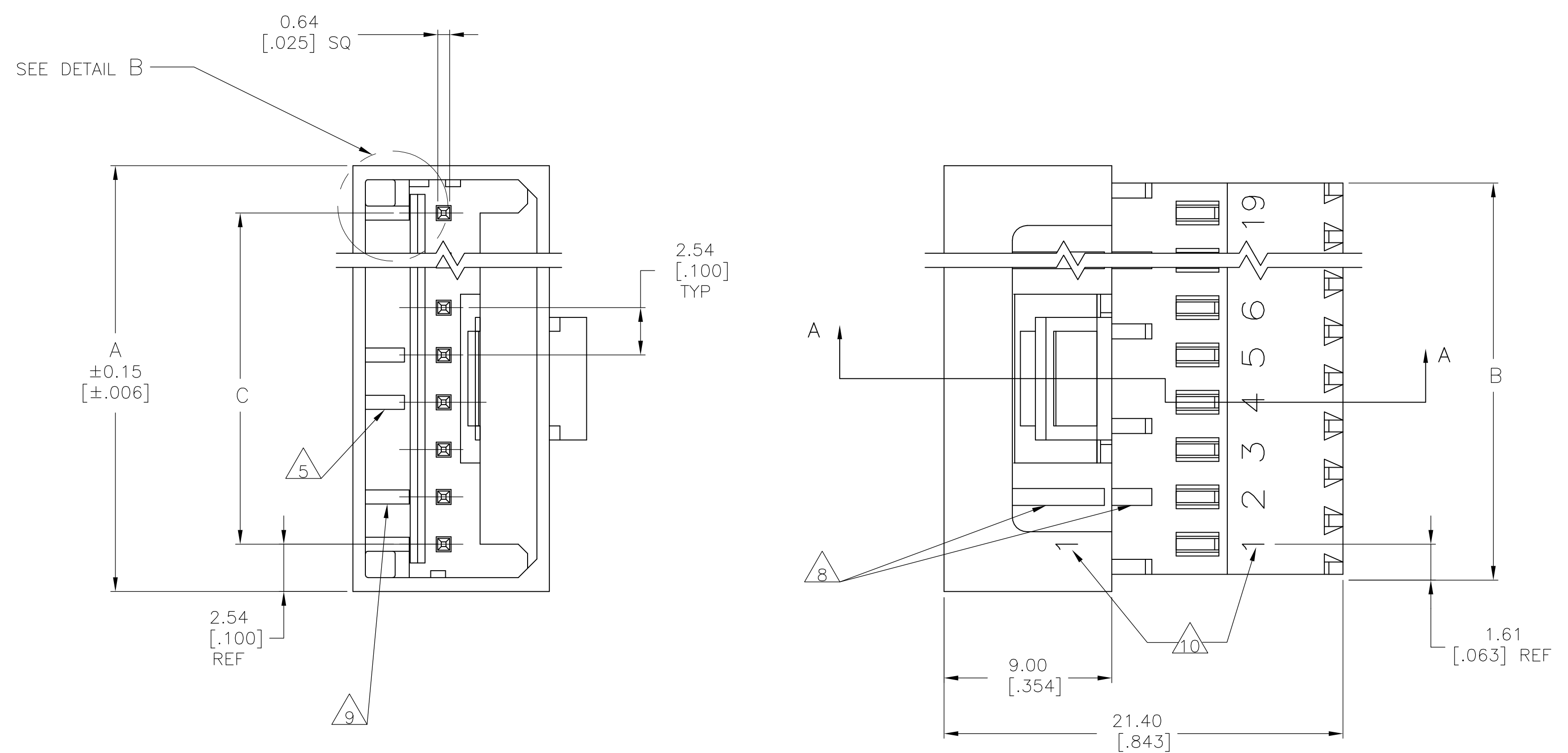
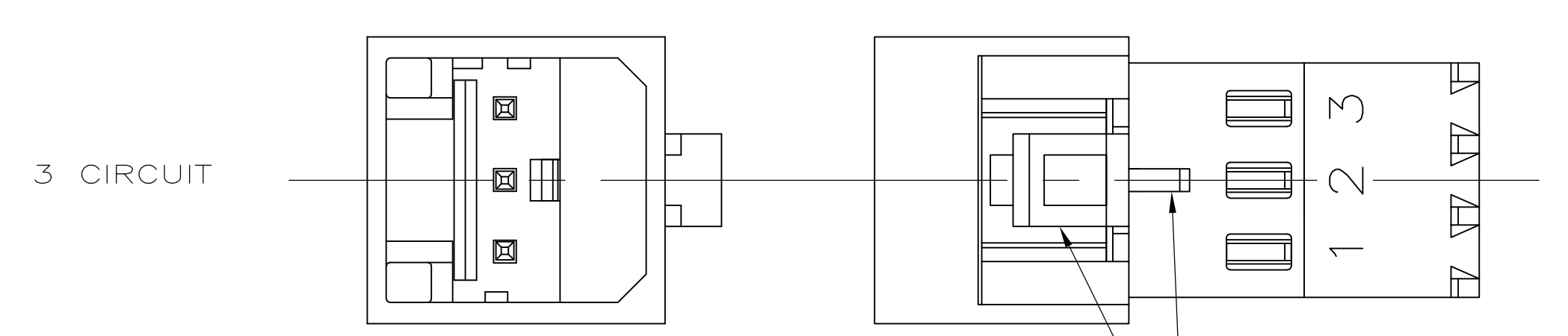
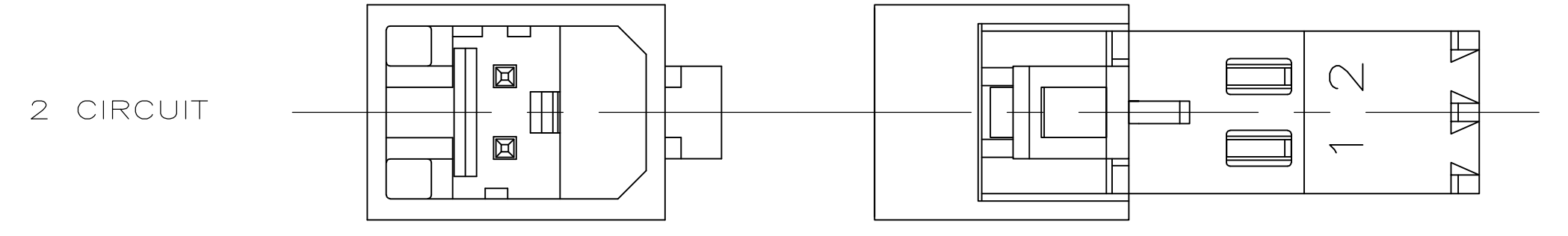

DETAIL A 3

DETAIL B
SCALE 10:1
ALTERNATE CONFIGURATION



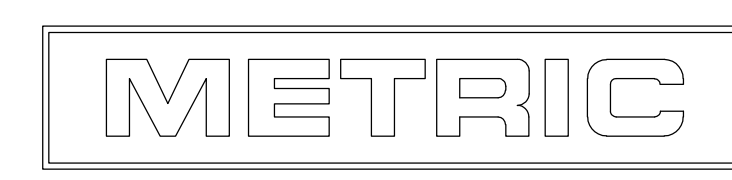

- 1 MATERIAL:
HOUSING- NYLON UL94V-2 .
CONTACTS- 0.30 [.012] THK COPPER ALLOY
PLATING : BRIGHT TIN-LEAD FOR 0.00203[.000080] MIN THK FOR 647002-2 THRU 1-647002-9 OR MATTE TIN 0.00203[.000080] MIN THK. FOR 3-647002-2 THRU 4-647002-9,
- 2 CONTACTS ACCEPT 26 AWG (0.12 - 0.15 mm²) TIN PLATED SOLID, CONCENTRIC FUSED STRANDED, OR CONCENTRIC STRANDED (7 STRANDS) WIRE WITH 1.52 [.060] MAX INSULATION DIAMETER.
- 3 MATES WITH STANDARD MTA-100 CONNECTORS: OF THE SAME CIRCUIT SIZES WITH SIMILARLY PLATED CONTACTS WITH POLARIZING TABS-CIRCUIT SIZES 4-19 ONLY WITHOUT POLARIZING TABS-CIRCUIT SIZES 2 & 3.





DOES NOT MATE WITH MTA-100 CONNECTORS: WITH POLARIZING TABS-CIRCUIT SIZES 2 & 3 ONLY. (SEE DETAIL A) WITH BLOCKED CIRCUITS -ALL CIRCUIT SIZES. NOT RECOMMENDED FOR MATING WITH MTA-100 CONNECTOR WITHOUT POLARIZING TABS. CIRCUIT SIZES 4-19.
- 4 ACCESSORIES:
REPLACEMENT IDC CONTACTS: 647032-1.
COVERS: SEE TABLE
- 5 QUANTITY OF CENTRALLY POSITIONED RAILS VARIES WITH CIRCUIT SIZE. (SEE TABLE) LOCATION MAY DIFFER FROM EXAMPLE SHOWN.
- 6 DIMENSIONS IN BRACKETS ARE IN INCHES.
- 7 SIMILAR SIZED LOCK AND SINGLE TAB USED OR CIRCUITS 4 & 5.
- 8 QUANTITY OF GUSSET RIBS VARIES WITH CIRCUIT SIZE (SEE TABLE). LOCATION MAY DIFFER FROM EXAMPLE SHOWN.
- 9 INNER END RAIL PAIR NOT PRESENT FOR CIRCUIT SIZES 2 OR 3.
- 10 CIRCUIT ID MAY APPEAR FULLY NUMBERED OR SHOWING LOCATION 1 ONLY DEPENDING ON CIRCUIT SIZE.
- 11 OBSOLETE PARTS: OBSOLETE CIS STREAMLINING PER D.RENAUD/D.SINISI
- 12 BLUE COLOR STRIPE ON HOUSING (NOT SHOWN) MAY RUN DOWN BETWEEN RIBS.



THIS DRAWING IS A CONTROLLED DOCUMENT.		DIN R LEWIS 29--98	TE Connectivity
DIMENSIONS: mm [INCHES]		CIK R SWING 29--98	
TOLERANCES UNLESS OTHERWISE SPECIFIED:		APVD J. ELLIS 29--98	NAME
0 PLC ± -			MTA-100 POSTED CONNECTOR ASSEMBLY, CLOSED END, 26 AWG
1 PLC ± -			PRODUCT SPEC
2 PLC ± 0.20 [.007]			APPLICATION SPEC
3 PLC ± -			WEIGHT
4 PLC ± -			SIZE
ANGLES ± -			CAGE CODE
MATERIAL 1	FINISH 1		DRAWING NO
			A1 00779
			647002
			RESTRICTED TO
			CUSTOMER DRAWING
			SCALE 5:1
			SHEET 1 OF 2
			REV E

QTY OF GUSSET RIBS	QTY OF CENTRAL RAILS	MM	IN	MM	IN	MM	IN	NO. OF CIRCUITS	PART NO
4	2	45.72	1.800	48.95	1.927	50.80	2.000	19	4-647002-9
4	2	43.18	1.700	46.41	1.827	48.26	1.900	18	4-647002-8
4	2	40.64	1.600	43.86	1.727	45.72	1.800	17	4-647002-7
4	2	38.10	1.500	41.32	1.627	43.18	1.700	16	4-647002-6
4	2	35.56	1.400	38.78	1.527	40.64	1.600	15	4-647002-5
4	2	33.02	1.300	36.24	1.427	38.10	1.500	14	4-647002-4
4	2	30.48	1.200	33.70	1.327	35.56	1.400	13	4-647002-3
2	1	27.94	1.100	31.16	1.227	33.02	1.300	12	4-647002-2
2	1	25.40	1.000	28.62	1.127	30.48	1.200	11	4-647002-1
2	1	22.86	.900	26.08	1.027	27.94	1.100	10	4-647002-0
2	1	20.32	.800	23.54	.927	25.40	1.000	9	3-647002-9
2	0	17.78	.700	21.00	.827	22.86	.900	8	3-647002-8
0	0	15.24	.600	18.46	.727	20.32	.800	7	3-647002-7
0	0	12.70	.500	15.92	.627	17.78	.700	6	3-647002-6
0	0	10.16	.400	13.38	.527	15.24	.600	5	3-647002-5
0	0	7.62	.300	10.84	.427	12.70	.500	4	3-647002-4
0	0	5.08	.200	8.30	.327	10.16	.400	3	3-647002-3
0	0	2.54	.100	5.76	.227	7.62	.300	2	3-647002-2
4	2	45.72	1.800	48.95	1.927	50.80	2.000	19	4-647002-9
4	2	43.18	1.700	46.41	1.827	48.26	1.900	18	4-647002-8
4	2	40.64	1.600	43.86	1.727	45.72	1.800	17	4-647002-7
4	2	38.10	1.500	41.32	1.627	43.18	1.700	16	4-647002-6
4	2	35.56	1.400	38.78	1.527	40.64	1.600	15	4-647002-5
4	2	33.02	1.300	36.24	1.427	38.10	1.500	14	4-647002-4
4	2	30.48	1.200	33.70	1.327	35.56	1.400	13	4-647002-3
2	1	27.94	1.100	31.16	1.227	33.02	1.300	12	4-647002-2
2	1	25.40	1.000	28.62	1.127	30.48	1.200	11	4-647002-1
2	1	22.86	.900	26.08	1.027	27.94	1.100	10	4-647002-0
2	1	20.32	.800	23.54	.927	25.40	1.000	9	4-647002-9
2	0	17.78	.700	21.00	.827	22.86	.900	8	4-647002-8
0	0	15.24	.600	18.46	.727	20.32	.800	7	4-647002-7
0	0	12.70	.500	15.92	.627	17.78	.700	6	4-647002-6
0	0	10.16	.400	13.38	.527	15.24	.600	5	4-647002-5
0	0	7.62	.300	10.84	.427	12.70	.500	4	647002-4
0	0	5.08	.200	8.30	.327	10.16	.400	3	647002-3
0	0	2.54	.100	5.76	.227	7.62	.300	2	4-647002-2

 SUPERCEDED
 SUPERCEDED
 SUPERCEDED
 SUPERCEDED

DUST COVER	STRAIN RELIEF COVERS	QTY OF GUSSET RIBS	QTY OF CENTRAL RAILS	MM	IN	MM	IN	MM	IN	NO. OF CIRCUITS	PART NO
				C		B		A			
ACCESSORIES											

THIS DRAWING IS A CONTROLLED DOCUMENT.

DIN B. LEWIS 29--98	MTA-100 POSTED CONNECTOR ASSEMBLY, CLOSED END, 26 AWG
CIK R. SWING 29--98	NAME
APVD J. ELLIS 29--98	PRODUCT SPEC
APPLICATION SPEC	RESTRICTED TO
WEIGHT	SCALE 5:1 SHEET 2 OF 2 REV E

