

THIS DRAWING IS UNPUBLISHED. RELEASED FOR PUBLICATION  
 © COPYRIGHT BY TYCO ELECTRONICS CORPORATION. ALL RIGHTS RESERVED.

LOC		DIST		REVISIONS			
P	LTR	DESCRIPTION	DATE	DWN	APVD		
AD	00	H	REVISED PER EC 0512-0273-05	19SEP05	JDP	DD	

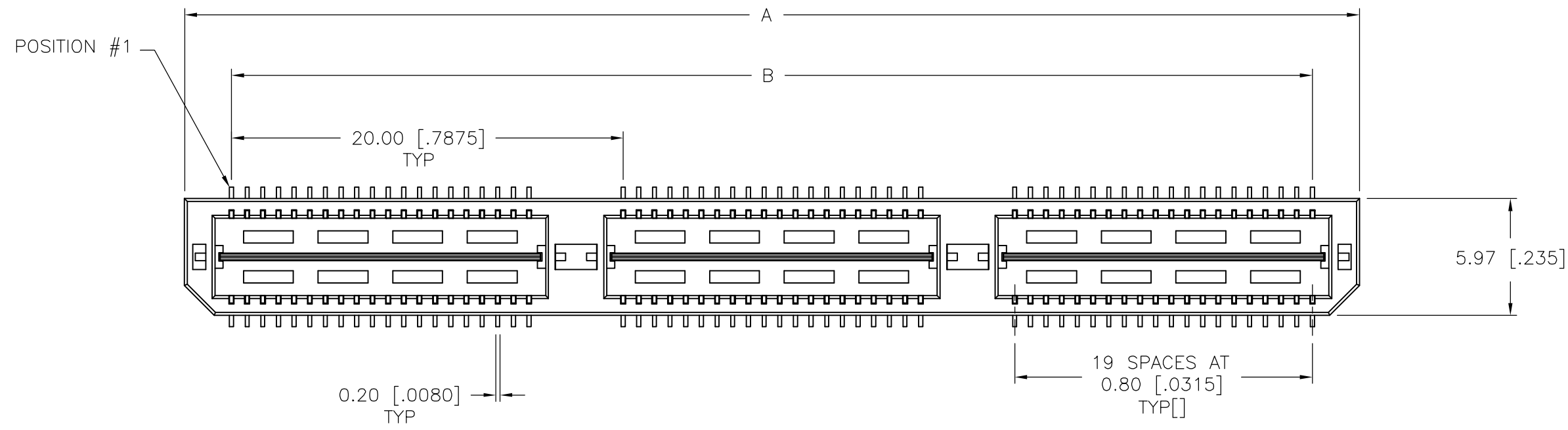

- 1 HOUSING: LCP, BLACK.  
CONTACT & GROUND PLANE: PHOS BRONZE.
- 2 CONTACT PLATING: SELECT 0.25 MICROMETERS (.000010 IN.) MIN. GOLD.
- 3 FOR STANDARD APPLICATIONS, ORIENTATION HOLE TO BE  $\phi 1.02$  [ $\phi .0400$ ].

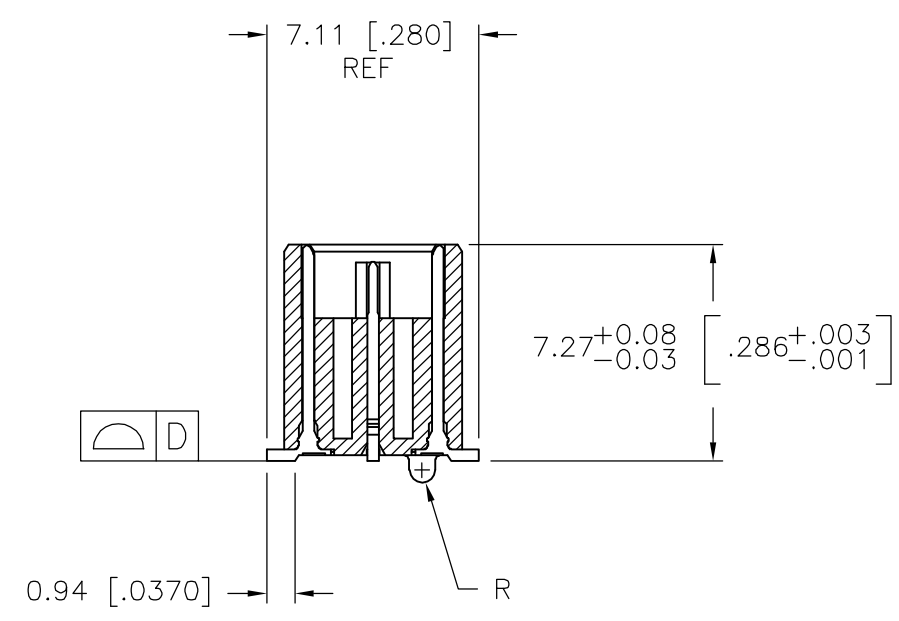
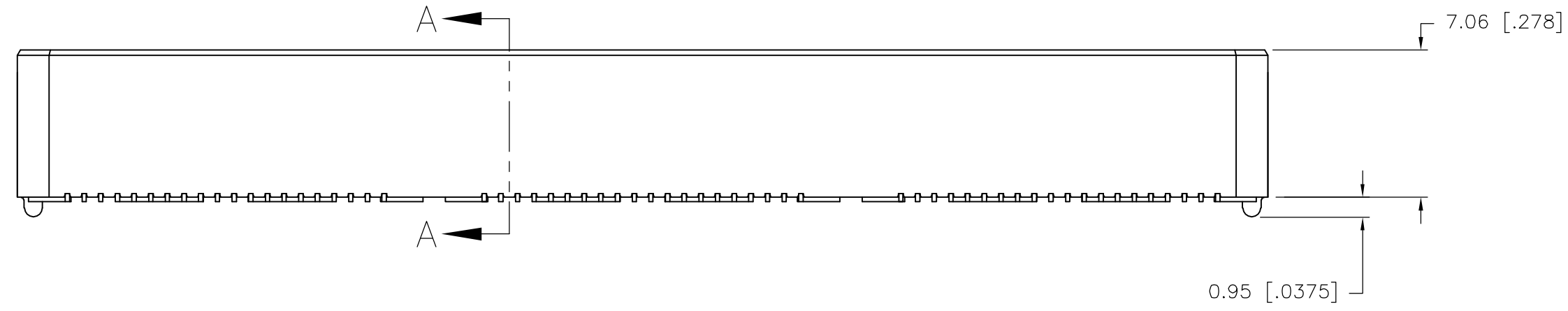

SECTION A-A

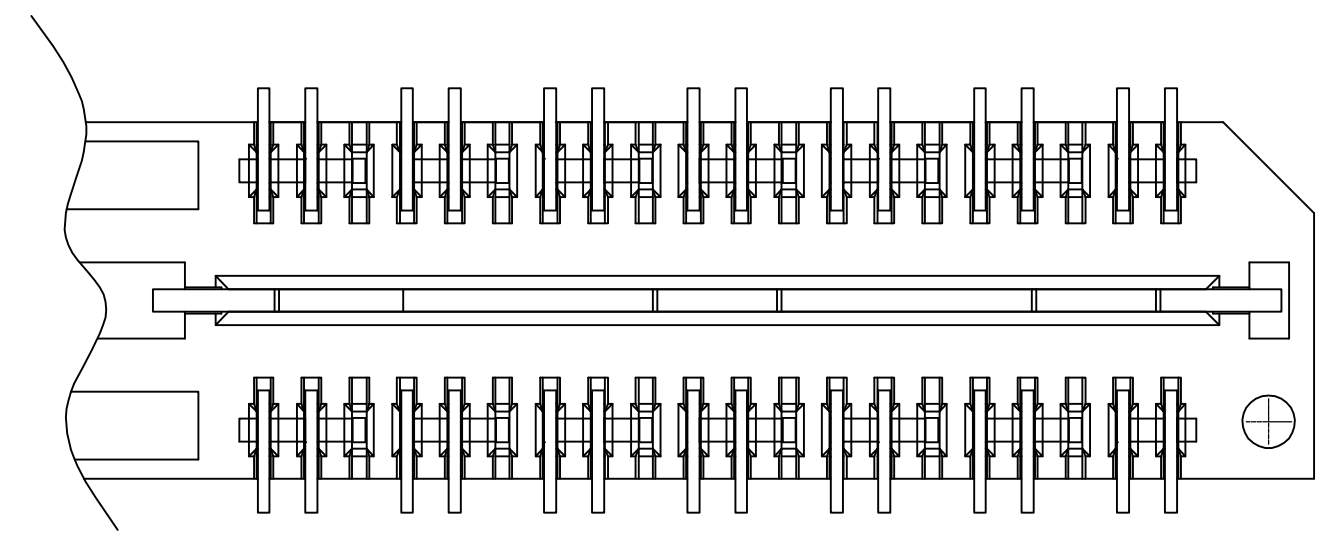
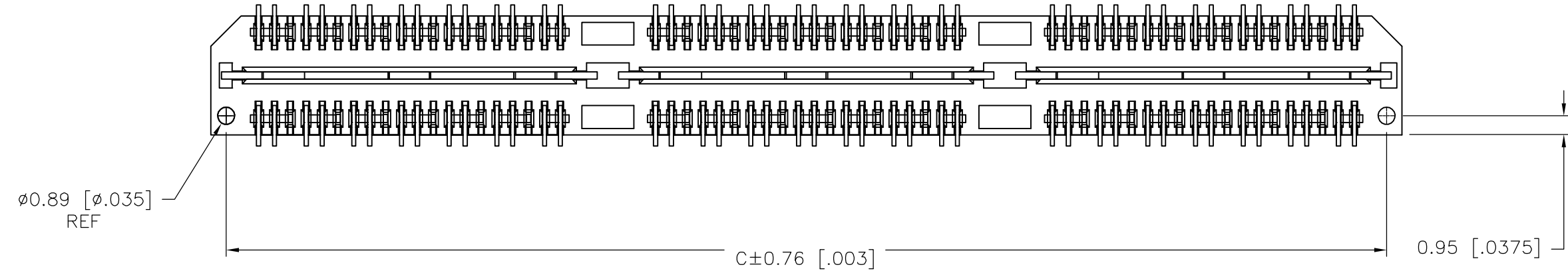

DIFFERENTIAL PAIR LOADING  
(BOTTOM VIEW)  
SCALE 2:1

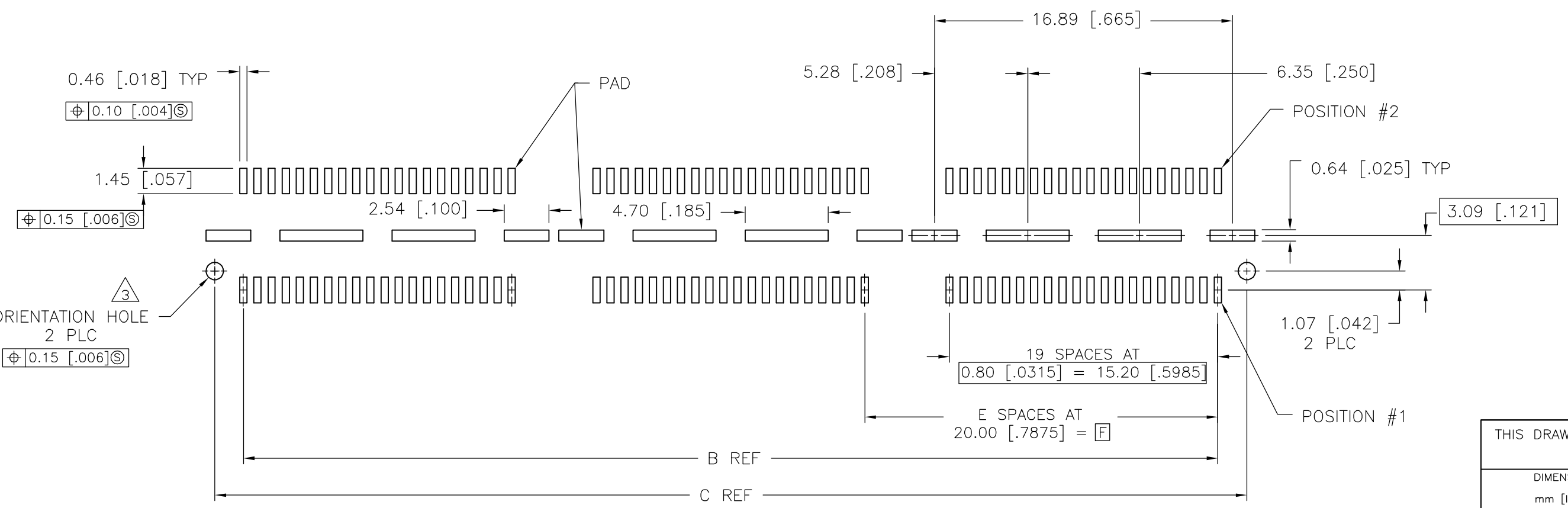

RECOMMENDED PC BOARD LAYOUT  
(VIEWED FROM CONNECTOR SIDE)

THIS DRAWING IS A CONTROLLED DOCUMENT.		DWN B. CARRO	30JAN03	 Tyco Electronics Corporation Harrisburg, PA 17105-3608	RESTRICTED TO		
DIMENSIONS: mm [INCHES]		CHK D. DIXON	30JAN03		NAME HEADER ASSEMBLY, 8.0MM [.315] VERTICAL, 0.80MM CL, MICTOR SB	SIZE	RESTRICTED TO
TOLERANCES UNLESS OTHERWISE SPECIFIED:		APVD D. DIXON	30JAN03			CAGE CODE	RESTRICTED TO
0 PLC ± - 1 PLC ± 0.3[.01] 2 PLC ± 0.13[.005] 3 PLC ± 0.051[.0020] 4 PLC ± - ANGLES ± 2° FINISH		PRODUCT SPEC	-		DRAWING NO	RESTRICTED TO	
MATERIAL		APPLICATION SPEC	-	SCALE	SHEET	REV	
1		WEIGHT	-	A2	1 of 2	H	
2		CUSTOMER DRAWING		00779	3:1		

THIS DRAWING IS UNPUBLISHED. RELEASED FOR PUBLICATION  
 © COPYRIGHT BY TYCO ELECTRONICS CORPORATION. ALL RIGHTS RESERVED.

LOC	DIST	REVISIONS					
AD	00	P	LTR	DESCRIPTION	DATE	DWN	APVD
		-	-	SEE SHEET 1	-	-	-

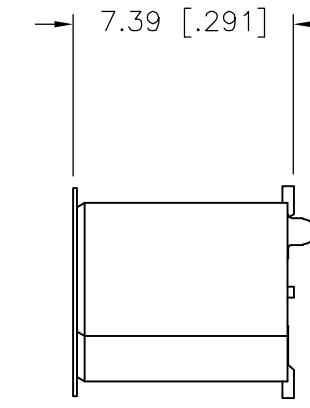
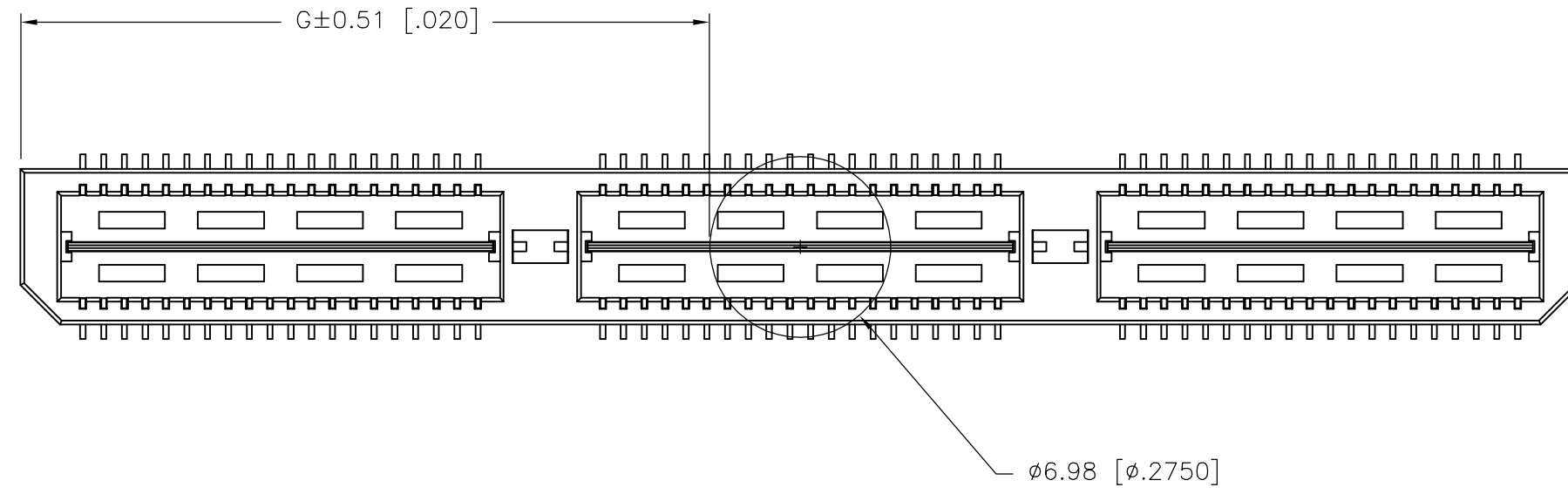

26.52(1.044)	40.00(1.575)	2	0.102(.0040)	58.50(2.303)	55.20(2.173)	60.00(2.362)	YES	POCKET TAPE	YES	84	7-1658014-3
16.51(.650)	20.00(.7874)	1	0.102(.0040)	38.48(1.515)	35.20(1.386)	40.00(1.575)	YES	POCKET TAPE	YES	56	7-1658014-2
6.50(.256)	0(.000)	0	0.102(.0040)	18.49(.728)	15.20(.598)	20.00(.787)	YES	POCKET TAPE	YES	28	7-1658014-1
26.52(1.044)	40.00(1.575)	2	0.102(.0040)	58.50(2.303)	55.20(2.173)	60.00(2.362)	YES	POCKET TAPE	NO	120	6-1658014-3
16.51(.650)	20.00(.7874)	1	0.102(.0040)	38.48(1.515)	35.20(1.386)	40.00(1.575)	YES	POCKET TAPE	NO	80	6-1658014-2
6.50(.256)	0(.000)	0	0.102(.0040)	18.49(.728)	15.20(.598)	20.00(.787)	YES	POCKET TAPE	NO	40	6-1658014-1
-	40.00(1.575)	2	0.102(.0040)	58.50(2.303)	55.20(2.173)	60.00(2.362)	NO	POCKET TAPE	YES	84	5-1658014-3
-	20.00(.7874)	1	0.102(.0040)	38.48(1.515)	35.20(1.386)	40.00(1.575)	NO	POCKET TAPE	YES	56	5-1658014-2
-	0(.000)	0	0.102(.0040)	18.49(.728)	15.20(.598)	20.00(.787)	NO	POCKET TAPE	YES	28	5-1658014-1
-	40.00(1.575)	2	0.102(.0040)	58.50(2.303)	55.20(2.173)	60.00(2.362)	NO	POCKET TAPE	NO	120	4-1658014-3
-	20.00(.7874)	1	0.102(.0040)	38.48(1.515)	35.20(1.386)	40.00(1.575)	NO	POCKET TAPE	NO	80	4-1658014-2
-	0(.000)	0	0.102(.0040)	18.49(.728)	15.20(.598)	20.00(.787)	NO	POCKET TAPE	NO	40	4-1658014-1
46.51(1.831)	80.00(3.150)	4	0.152(.0060)	98.50(3.748)	95.20(3.748)	100.00(3.937)	YES	TRAY	YES	140	3-1658014-5
36.53(1.438)	60.00(2.362)	3	0.152(.0060)	78.49(3.090)	75.20(2.961)	80.00(3.150)	YES	TRAY	YES	112	3-1658014-4
26.52(1.044)	40.00(1.575)	2	0.102(.0040)	58.50(2.303)	55.20(2.173)	60.00(2.362)	YES	TRAY	YES	84	3-1658014-3
16.51(.650)	20.00(.7874)	1	0.102(.0040)	38.48(1.515)	35.20(1.386)	40.00(1.575)	YES	TRAY	YES	56	3-1658014-2
6.50(.256)	0(.000)	0	0.102(.0040)	18.49(.728)	15.20(.598)	20.00(.787)	YES	TRAY	YES	28	3-1658014-1
46.51(1.831)	80.00(3.150)	4	0.152(.0060)	98.50(3.748)	95.20(3.748)	100.00(3.937)	YES	TRAY	NO	200	2-1658014-5
36.53(1.438)	60.00(2.362)	3	0.152(.0060)	78.49(3.090)	75.20(2.961)	80.00(3.150)	YES	TRAY	NO	160	2-1658014-4
26.52(1.044)	40.00(1.575)	2	0.102(.0040)	58.50(2.303)	55.20(2.173)	60.00(2.362)	YES	TRAY	NO	120	2-1658014-3
16.51(.650)	20.00(.7874)	1	0.102(.0040)	38.48(1.515)	35.20(1.386)	40.00(1.575)	YES	TRAY	NO	80	2-1658014-2
6.50(.256)	0(.000)	0	0.102(.0040)	18.49(.728)	15.20(.598)	20.00(.787)	YES	TRAY	NO	40	2-1658014-1
-	80.00(3.150)	4	0.152(.0060)	98.50(3.748)	95.20(3.748)	100.00(3.937)	NO	TRAY	YES	140	1-1658014-5
-	60.00(2.362)	3	0.152(.0060)	78.49(3.090)	75.20(2.961)	80.00(3.150)	NO	TRAY	YES	112	1-1658014-4
-	40.00(1.575)	2	0.102(.0040)	58.50(2.303)	55.20(2.173)	60.00(2.362)	NO	TRAY	YES	84	1-1658014-3
-	20.00(.7874)	1	0.102(.0040)	38.48(1.515)	35.20(1.386)	40.00(1.575)	NO	TRAY	YES	56	1-1658014-2
-	0(.000)	0	0.102(.0040)	18.49(.728)	15.20(.598)	20.00(.787)	NO	TRAY	YES	28	1-1658014-1
-	80.00(3.150)	4	0.152(.0060)	98.50(3.748)	95.20(3.748)	100.00(3.937)	NO	TRAY	NO	200	1658014-5
-	60.00(2.362)	3	0.152(.0060)	78.49(3.090)	75.20(2.961)	80.00(3.150)	NO	TRAY	NO	160	1658014-4
-	40.00(1.575)	2	0.102(.0040)	58.50(2.303)	55.20(2.173)	60.00(2.362)	NO	TRAY	NO	120	1658014-3
-	20.00(.7874)	1	0.102(.0040)	38.48(1.515)	35.20(1.386)	40.00(1.575)	NO	TRAY	NO	80	1658014-2
-	0(.000)	0	0.102(.0040)	18.49(.728)	15.20(.598)	20.00(.787)	NO	TRAY	NO	40	1658014-1
G	F	E	D	C	B	A	POLYIMIDE FILM PAD ▲	PACKAGING TYPE	DIFF. PAIR	NO OF POS	PART NUMBER

THIS DRAWING IS A CONTROLLED DOCUMENT.

DWN	B. CARRO	30JAN03
CHK	D. DIXON	30JAN03
APVD	D. DIXON	30JAN03
PRODUCT SPEC	-	-
APPLICATION SPEC	-	-
WEIGHT	-	-
CUSTOMER DRAWING	SCALE 3:1 SHEET 2 of 2 REV H	

tyco Electronics  
 Tyco Electronics Corporation  
 Harrisburg, PA 17105-3608

NAME: HEADER ASSEMBLY, 8.0MM [.315] VERTICAL, 0.80MM CL, MICTOR SB

SIZE: A2 CAGE CODE: 00779 C=1658014