



DFS20A-A2BAD005000

DFS2x

INCREMENTAL ENCODERS

SICK
Sensor Intelligence.



Illustration may differ



Ordering information

Type	Part no.
DFS20A-A2BAD005000	1094811

Other models and accessories → www.sick.com/DFS2x

Detailed technical data

Performance

Pulses per revolution	5,000
Measuring step	± 0.08° electronically/ppr
Measuring step deviation	± 0.008°
Error limits	± 0.3°
Initialization time	40 ms ¹⁾

¹⁾ Valid positional data can be read once this time has elapsed.

Electrical data

Electrical interface	8 V ... 30 V, HTL/Push pull
Connection type	Male connector, radial ¹⁾
Power consumption	0.7 W (without load)
Output frequency	820 kHz
Reference signal, number	1
Reference signal, position	180°, electronically, gated with B negative
Code sequence	Clockwise

¹⁾ Zero set possible.

Mechanical data

Mechanical design	Solid shaft, Square flange
Shaft diameter	3/8"
Weight	+ 0.4 kg (maximum)
Start up torque	0.5 Ncm (+20 °C)
Operating torque	0.3 Ncm (+20 °C)
Permissible shaft loading radial/axial	40 N (axial) 80 N (radial)
Operating speed	9,000 min ⁻¹
Moment of inertia of the rotor	15 gcm ²

Bearing lifetime	3.6 x 10 ⁹ revolutions
Angular acceleration	≤ 500,000 rad/s ²

Ambient data

EMC	According to EN 61000-6-2 and EN 61000-6-3
Enclosure rating	IP65 (according to IEC 60529)
Permissible relative humidity	90 % (Condensation not permitted)
Operating temperature range	-30 °C ... +85 °C
Storage temperature range	-40 °C ... +100 °C, without package
Resistance to shocks	100 g, 11 ms (according to EN 60068-2-27)
Resistance to vibration	30 g, 10 Hz ... 2,000 Hz (according to EN 60068-2-6)

Classifications

ECl@ss 5.0	27270501
ECl@ss 5.1.4	27270501
ECl@ss 6.0	27270590
ECl@ss 6.2	27270590
ECl@ss 7.0	27270501
ECl@ss 8.0	27270501
ECl@ss 8.1	27270501
ECl@ss 9.0	27270501
ETIM 5.0	EC001486
ETIM 6.0	EC001486
UNSPSC 16.0901	41112113

Dimensional drawing (Dimensions in mm (inch))

SHAFT OPTIONS		
NOMINAL	SHAFT Ø "A"	FLAT DIM "B"
1/4"	6.327/6.312/2491/2485	5.5[.22]
3/8"	9.507/9.492[.3743/.3737]	8.5[.33]
10MM	9.977/9.962[.3928/.3922]	9[.35]

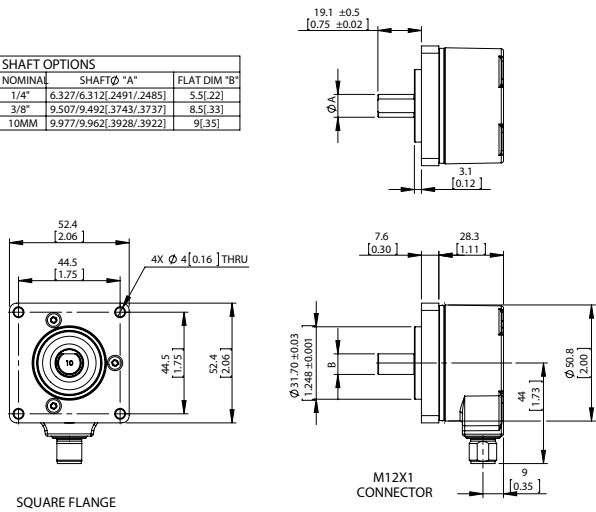

MIL CONNECTOR OPTIONS	
TYPE	DIM "C"
6 PIN	63.9[2.52]
7 PIN	63.9[2.52]
10 PIN	69.4[2.73]

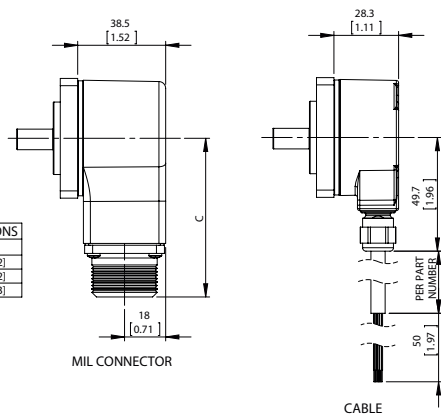

PIN assignment

View of the plug-in face

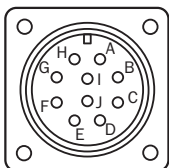

SICK AT A GLANCE

SICK is one of the leading manufacturers of intelligent sensors and sensor solutions for industrial applications. A unique range of products and services creates the perfect basis for controlling processes securely and efficiently, protecting individuals from accidents and preventing damage to the environment.

We have extensive experience in a wide range of industries and understand their processes and requirements. With intelligent sensors, we can deliver exactly what our customers need. In application centers in Europe, Asia and North America, system solutions are tested and optimized in accordance with customer specifications. All this makes us a reliable supplier and development partner.

Comprehensive services complete our offering: SICK LifeTime Services provide support throughout the machine life cycle and ensure safety and productivity.

For us, that is “Sensor Intelligence.”

WORLDWIDE PRESENCE:

Contacts and other locations –www.sick.com