





# COMMON MODE CHOKES

## For DSL and Telecom Applications



-  Family of 2-wire Common Mode Chokes
-  Low profile surface mount package
-  Cost effective construction with Pulse SLIC patented technology
-  Range suited for many DSL and Telecom applications

### Electrical Specifications @ 25°C / 80 Vdc — Operating Temperature -40°C to +85°C

Standard Part Number	RoHS-6 Compliant Part Number	OCL (mH +50% / -30%)	L <sub>L</sub> (μH TYP)	DCR (Ω MAX)	Current Rating (mA <sub>dc</sub> )	Isolation (V <sub>rms</sub> )
T8116T	T8116NLT	0.47	0.2	0.3	700	500
T8112T	T8112NLT	1.00	0.2	0.3	700	500
T8113T	T8113NLT	2.20	0.25	0.4	500	500
T8114T	T8114NLT	4.70	0.4	0.7	400	500

**NOTE:** Other custom inductance values available on request. Tube version available for sampling. Please contact Pulse Applications Engineering.

### Mechanical

### Schematic

PIL

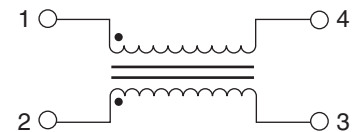
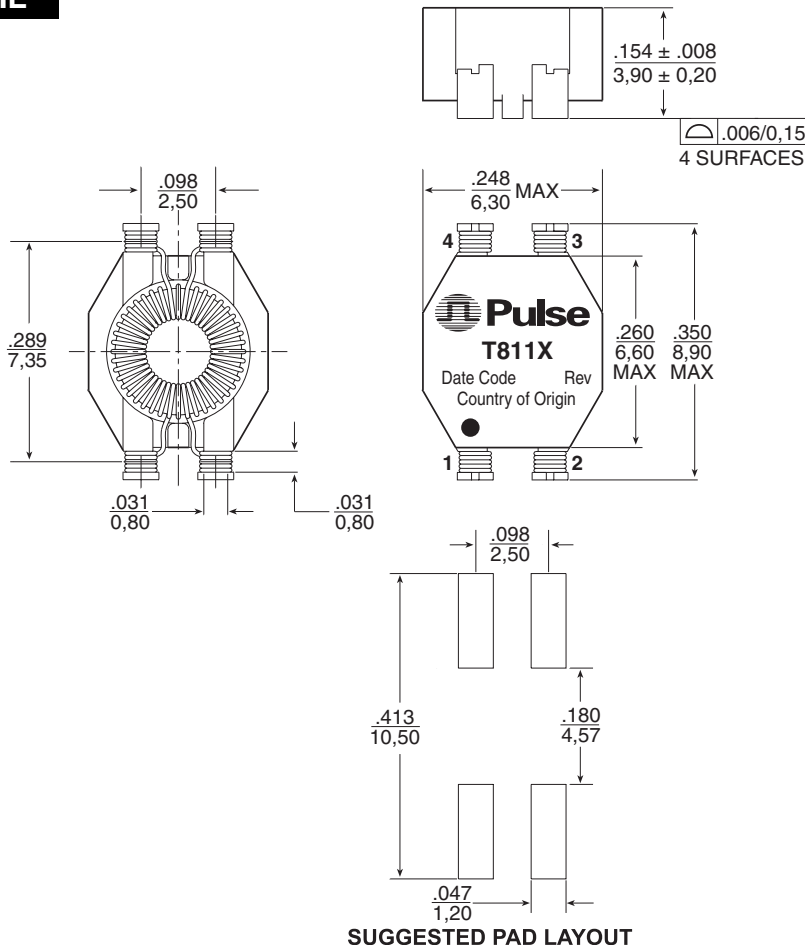

Weight ..... 0.2 grams  
 Tape & Reel ..... .1600/reel  
 Dimensions: Inches  
                   mm  
 Unless otherwise specified,  
 all tolerances are ± .010  
                           0,25

# COMMON MODE CHOKES

## For DSL and Telecom Applications



Impedance in Common Mode and Differential Mode  
T8116 (2 x 0.47mH)

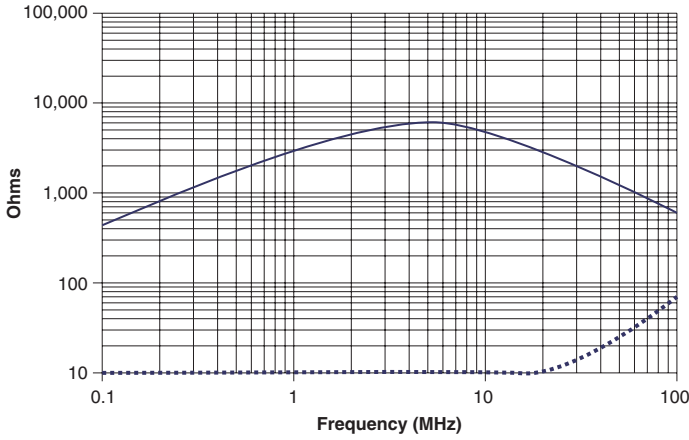

— Common Mode  
..... Differential Mode

Impedance in Common Mode and Differential Mode  
T8112 (2 x 1mH)

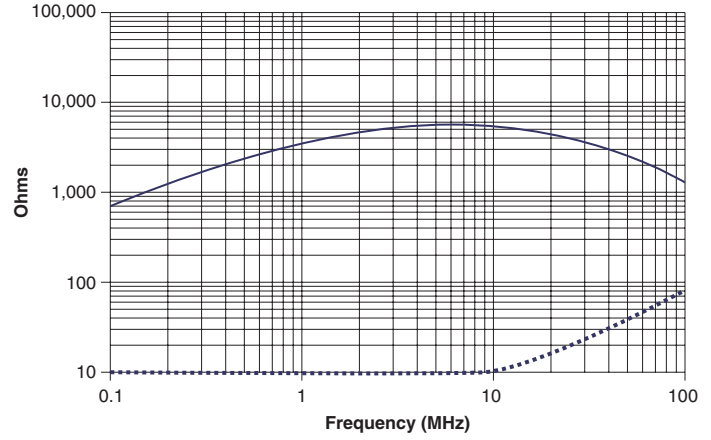

— Common Mode  
..... Differential Mode

Impedance in Common Mode and Differential Mode  
T8113 (2 x 2.2mH)

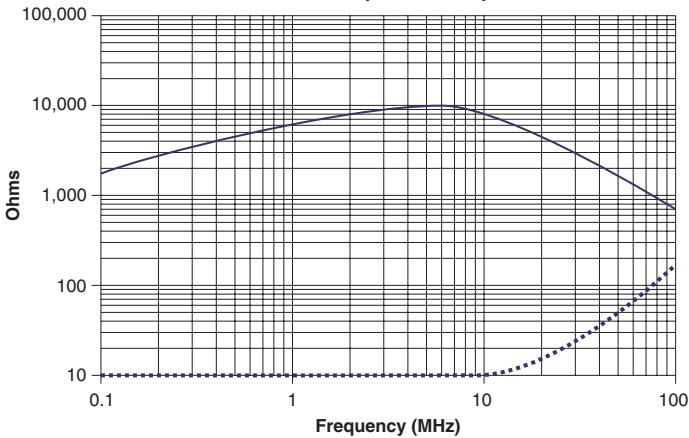

— Common Mode  
..... Differential Mode

Impedance in Common Mode and Differential Mode  
T8114 (2 x 4.7mH)

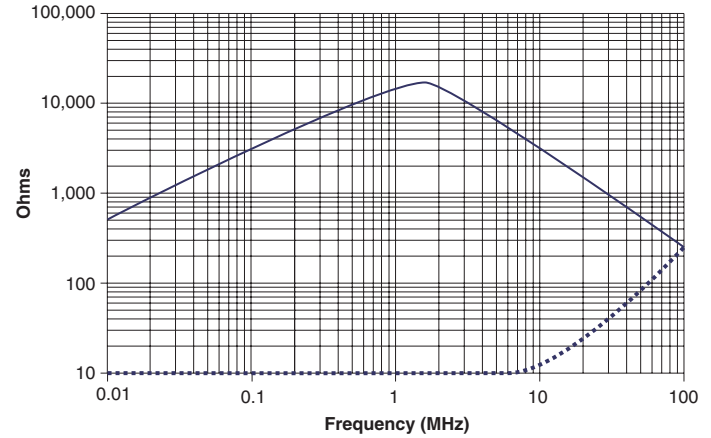

— Common Mode  
..... Differential Mode

### For More Information:

#### Pulse Worldwide Headquarters

12220 World Trade Drive  
San Diego, CA 92128  
U.S.A.

[www.pulseeng.com](http://www.pulseeng.com)  
TEL: 858 674 8100  
FAX: 858 674 8262

#### Pulse Northern Europe

3 Huxley Road  
Surrey Research Park  
Guildford, Surrey GU2 5RE  
United Kingdom

TEL: 44 1483 401700  
FAX: 44 1483 401701

#### Pulse Southern Europe

Zone Industrielle  
F-39270  
Orgelet  
France

TEL: 33 3 84 35 04 04  
FAX: 33 3 84 25 46 41

#### Pulse China Headquarters

No. 1  
Industrial District  
Changan, Dongguan  
China

TEL: 86 769 5538070  
FAX: 86 769 5538870

#### Pulse North China

Room 1503  
XinYin Building  
No. 888 YiShan Road  
Shanghai 200233  
China

TEL: 86 21 54643211/2  
FAX: 86 21 54643210

#### Pulse South Asia

150 Kampong Ampat  
#07-01/02  
KA Centre  
Singapore 368324

TEL: 65 6287 8998  
FAX: 65 6280 0080

#### Pulse North Asia

No. 26  
Kao Ching Road  
Yang Mei Chen  
Taoyuan Hsien  
Taiwan, R. O. C.

TEL: 886 3 4641811  
FAX: 886 3 4641911

Performance warranty of products offered on this data sheet is limited to the parameters specified. Data is subject to change without notice. Other brand and product names mentioned herein may be trademarks or registered trademarks of their respective owners.

© Copyright, 2006. Pulse Engineering, Inc. All rights reserved.

[www.pulseeng.com](http://www.pulseeng.com)

T673.B (2/06)