

# Two-stage general-purpose filter

# FN 660

- Current ratings from 1 to 20A
- High differential and common mode attenuation
- Four choices of output connector
- Optional medical versions (B type)
- Nennströme von 1 bis 20A
- Gute differentielle und Gleichtakt-Dämpfung
- Vier Anschlußarten
- Für medizinische Geräte als Option (Typ B)
- Courants de service de 1 à 20A
- Bonne atténuation en modes différentiel et commun
- Quatre types de connexions de sortie
- Version pour appareils médicaux en option (type B)



### Filter selection table

Choose the family FN xxx with the required current rating and features, and add /?? to determine input/output (line/load) connection style. Example: FN 660-3/07 is a 3A filter with wire connections.

### Approvals



Family	Connections				Current ratings at 40°C (25°) A	Inductance L/L1 mH	Housing	Weight g			
								/03	/06	/07	/10
FN 660 -1 /??		/06	/07		1 (1.15)	3/3	H21	115	125		
FN 660 -3 /??		/06	/07		3 (3.4)	2/2	K1	170	180		
FN 660 -6 /??		/06	/07		6 (6.9)	0.75/0.75	K1	170	180		
FN 660 -10 /??		/06	/07		10 (11.5)	0.45/0.45	K21	230	240		
FN 660 -16 /??	/03	/06		/10	16 (18.4)	0.44/0.44	K2	290	260		290
FN 660 -20 /??	/03	/06		/10	20 (23)	0.48/0.48	L1	600	590		640

### Additional specifications

Filter type	Capacitance		Res. R MΩ	Maximum leakage μA/phase	Maximum operating voltage		Operating frequency Hz	Hipot test voltage	
	Cx nF	Cy nF			VAC	Hz		PN→E VAC	P→N VAC
Standard types	150	2.2	1	190	250	50/60	DC to 400	2000	1700
B types (medical)	150		1	2	250	50/60	DC to 400	2500	1700

MTBF at 40°C, 230V, per Mil-HB-217F: 350,000 hours (for VDE-approved current ratings).

### Electrical schematic

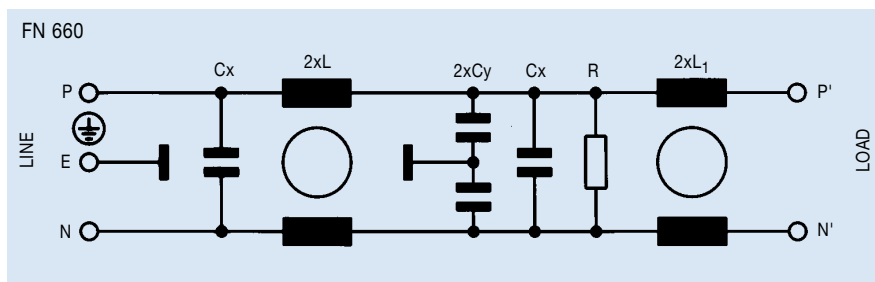

See tables for component values.

## FN 660 insertion loss

Per CISPR 17; A = 50Ω/50Ω sym, B = 50Ω/50Ω asym, C = 0.1Ω/100Ω sym, D = 100Ω/0.1Ω sym

### 1 amp types

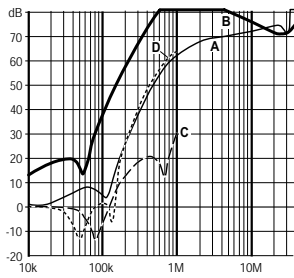

### 3 amp types

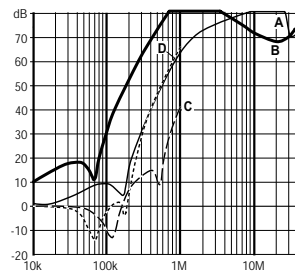

### 6 amp types

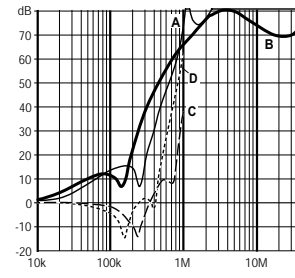

### 10 amp types

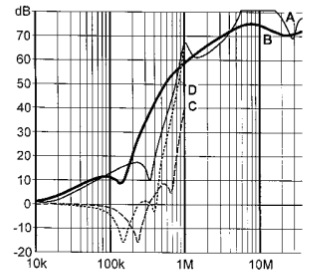

### 16 amp types

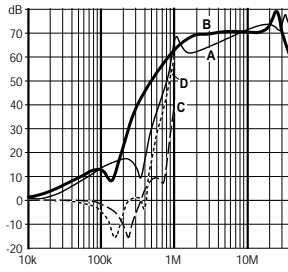

### 20 amp types

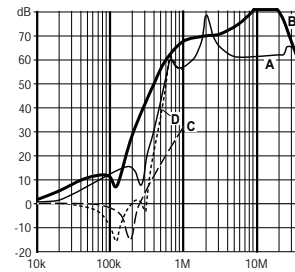

## Mechanical data

	FN 660-1 H21	Tol. mm
<b>A</b>	71	± 0.5
<b>B</b>	46.6	± 1
<b>C</b>	29	± 1
<b>D</b>	50.5	± 1
<b>F</b>	61	± 0.2
<b>J</b>	21 <sup>(J1)</sup> 8.5 <sup>(J2)</sup>	± 0.5
<b>K</b>	10.5	± 0.3
<b>L</b>	19	± 0.5
<b>M</b>	5.3	± 0.1
<b>N</b>	6.3	± 0.1
<b>Y</b>	6	± 1
<b>Z</b>	140	+ 5

### Front view

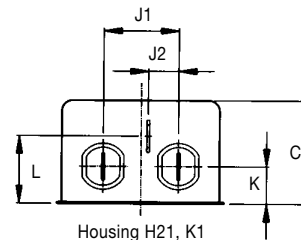
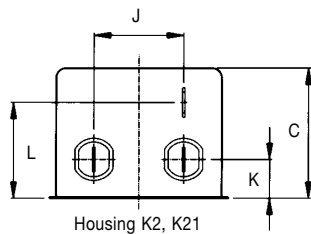

### Top view

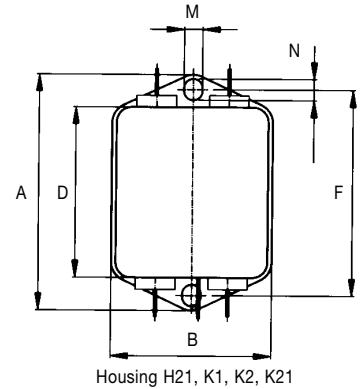

	FN 660 -3-6 K1	FN 660 -10/-16 K2, K21	FN 660 -20 L1	Tol.* mm
<b>A</b>		85	105	± 0.5
<b>B</b>		54	99.5 ± 1	± 0.5
<b>C</b>	30	40	38	± 1
<b>D</b>		65	84.5	± 1
<b>E</b>			79	± 0.5
<b>F</b>		75	95	± 0.2
<b>G</b>			51	± 0.1
<b>J</b>	27 <sup>(J1)</sup> 8.5 <sup>(J2)</sup>	27	40	± 0.5
<b>K</b>	7	12	9.5	± 0.5
<b>L</b>		29.5	19	± 0.5
<b>M</b>		5.3	4.4	± 0.1
<b>N</b>		6.3	6	± 0.1
<b>W</b>	AWG 16			-
<b>Y</b>		6		± 1
<b>Z</b>	300	140 + 5		+ 10

### Front view

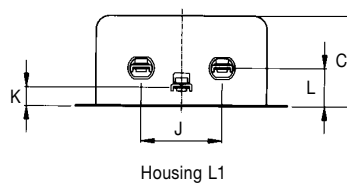

### Top view

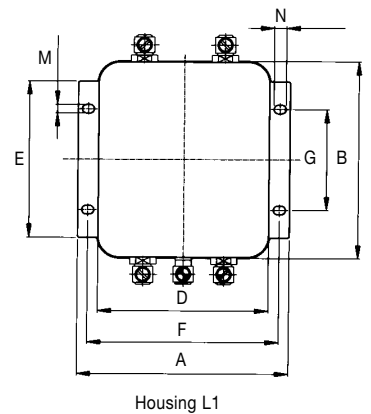

\* Measurements share this common tolerance unless otherwise stated.

All dimensions in mm; 1 inch = 25.4 mm