

For Air-Conditioner Fan Motor

3-Phase Brushless Fan Motor Driver

BM6206FS

General Description

This motor driver IC adopts PrestoMOS™ as the output transistor, and put in a small full molding package with the 150° commutation controller chip and the high voltage gate driver chip. The protection circuits for overcurrent, overheating, under voltage lock out and the high voltage bootstrap diode with current regulation are built-in. It provides optimum motor drive system and downsizing the built-in PCB of the motor.

Features

- 600V PrestoMOS™ built-in
- Output current 1.5A
- Bootstrap operation by floating high side driver (including diode)
- 150° commutation logic
- PWM control (Upper arm switching)
- Phase control supported from 0° to +30° at 1° intervals
- Rotational direction switch
- FG signal output with pulse number switch (4 or 12)
- VREG output (5V/30mA)
- Protection circuits provided: CL, OCP, TSD, UVLO, MLP and the external fault input
- Fault output (open drain)

Applications

- Air conditioners; air purifiers; water pumps; dishwashers; washing machines

Key Specifications

- Output MOSFET Voltage: 600V
- Driver Output Current (DC): ±1.5A (Max)
- Driver output Current (Pulse): ±2.5A (Max)
- Output MOSFET DC On Resistance: 2.7Ω (Typ)
- Duty Control Voltage Range: 2.1V to 5.4V
- Phase Control Range: 0° to +30°
- Operating Case Temperature: -20°C to +100°C
- Junction Temperature: +150°C
- Power Dissipation: 3.00W

Package

SSOP-A54_36

W (Typ) x D (Typ) x H (Max)

22.0 mm x 14.1 mm x 2.4 mm

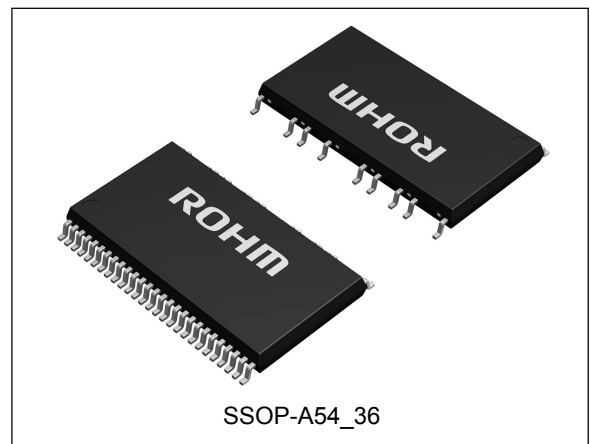

Typical Application Circuit

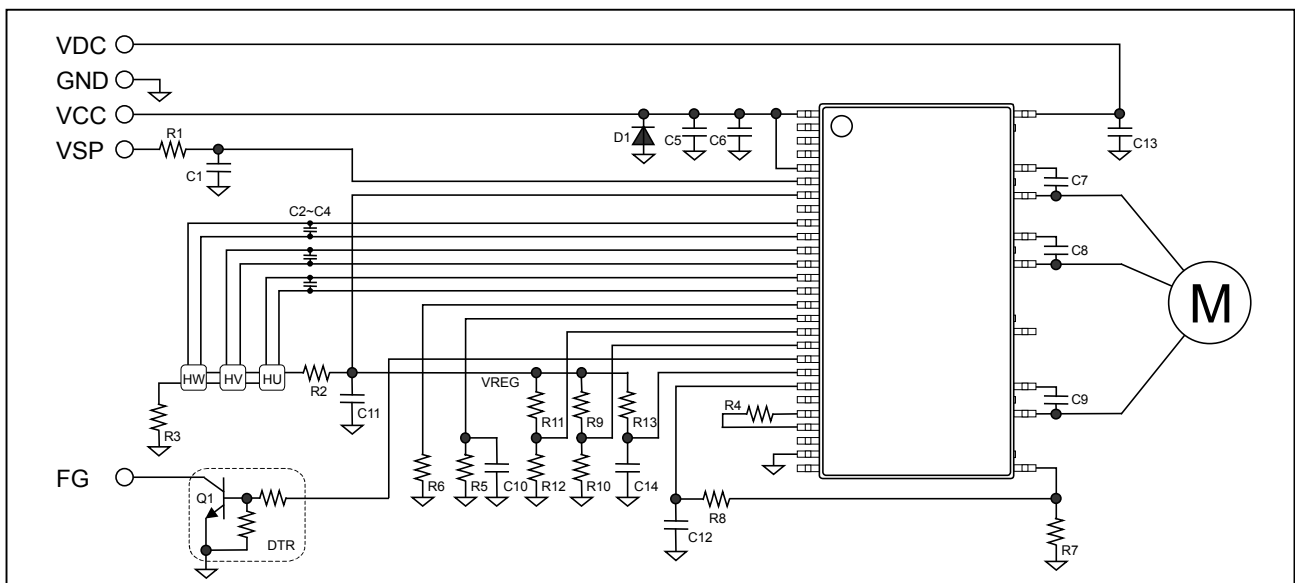

Figure 1. Application Circuit Example

Block Diagram and Pin Configuration

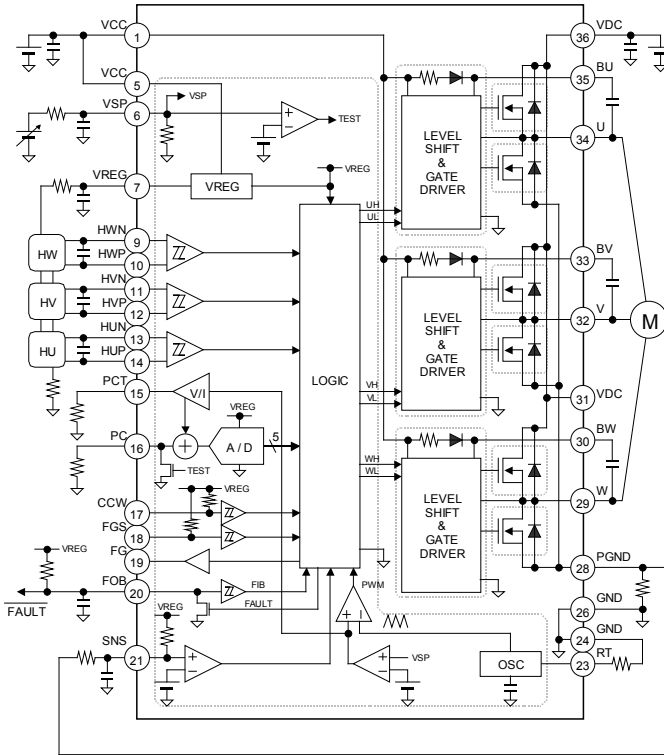

Figure 2. Block Diagram

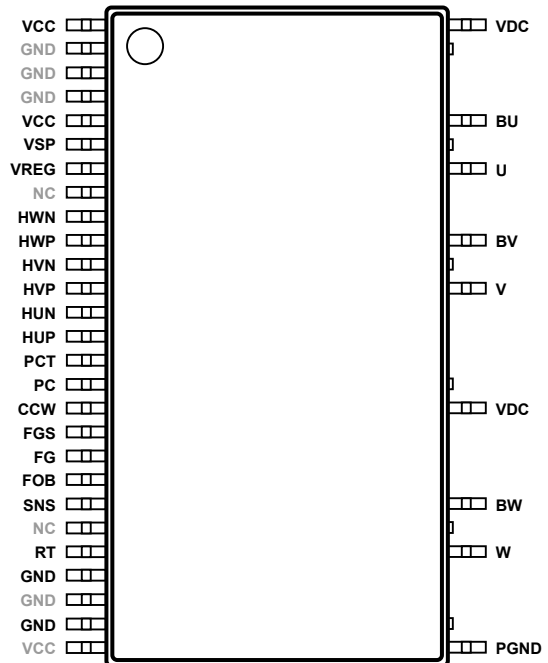

Figure 3. Pin Configuration (Top View)

Pin Descriptions (NC: No Connection)

Pin	Name	Function	Pin	Name	Function
1	VCC	Low voltage power supply	36	VDC	High voltage power supply
2	GND	Ground	-	VDC	
3	GND	Ground			
4	GND	Ground			
5	VCC	Low voltage power supply	35	BU	Phase U floating power supply
6	VSP	Duty control voltage input pin	-	U	
7	VREG	Regulator output	34	U	Phase U output
8	NC				
9	HWN	Hall input pin phase W-			
10	HWP	Hall input pin phase W+	33	BV	Phase V floating power supply
11	HVN	Hall input pin phase V-	-	V	
12	HVP	Hall input pin phase V+	32	V	Phase V output
13	HUN	Hall input pin phase U-			
14	HUP	Hall input pin phase U+			
15	PCT	VSP offset voltage output pin			
16	PC	Phase control input pin	-	VDC	
17	CCW	Direction switch (H:CCW)	31	VDC	High voltage power supply
18	FGS	FG pulse # switch (H:12, L:4)			
19	FG	FG signal output			
20	FOB	Fault signal output (open drain)			
21	SNS	Over current sense pin	30	BW	Phase W floating power supply
22	NC		-	W	
23	RT	Carrier frequency setting pin	29	W	Phase W output
24	GND	Ground			
25	GND	Ground			
26	GND	Ground	-	PGND	
27	VCC	Low voltage power supply	28	PGND	Ground (current sense pin)

Note) All pin cut surfaces visible from the side of package are no connected, except the pin number is expressed as a "-".

Description of Blocks

1. Commutation Logic

When the hall frequency is about 1.4-Hz or less (e.g. when the motor starts up), the commutation mode is 120° square wave drive with upper and lower switching (no lead angle). The controller monitors the hall frequency, and switches to 150° commutation drive when the hall frequency reaches or exceeds about 1.4-Hz over four consecutive cycles. Refer to the timing charts in figures 13 and 14.

Table 1. 120° Commutation (Six-State) Truth Table

HU	HV	HW	UH	VH	WH	UL	VL	WL
H	L	H	L	PWM	L	H	$\overline{\text{PWM}}$	L
H	L	L	L	L	PWM	H	L	$\overline{\text{PWM}}$
H	H	L	L	L	PWM	L	H	$\overline{\text{PWM}}$
L	H	L	PWM	L	L	$\overline{\text{PWM}}$	H	L
L	H	H	PWM	L	L	$\overline{\text{PWM}}$	L	H
L	L	H	L	PWM	L	L	$\overline{\text{PWM}}$	H

2. Duty Control

The switching duty can be controlled by forcing DC voltage with value from V_{SPMIN} to V_{SPMAX} to the VSP pin. When the VSP voltage is higher than V_{SPTST} , the controller forces PC pin voltage to ground (Testing mode, maximum duty and no lead angle). The VSP pin is pulled down internally by a 200 kΩ resistor. Therefore, note the impedance when setting the VSP voltage with a resistance voltage divider.

3. Carrier Frequency Setting

The carrier frequency setting can be freely adjusted by connecting an external resistor between the RT pin and ground. The RT pin is biased to a constant voltage, which determines the charge current to the internal capacitor. Carrier frequencies can be set within a range from about 16 kHz to 50 kHz. Refer to the formula to the right.

$$f_{osc} [kHz] = \frac{400}{R_T [kohm]}$$

4. FG Signal Output

The number of FG output pulses can be switched in accordance with the number of poles and the rotational speed of the motor. The FG signal is output from the FG pin. The 12-pulse signal is generated from the three hall signals (exclusive NOR), and the 4-pulse signal is the same as hall U signal. It is recommended to pull up FGS pin to VREG voltage when malfunctioning because of the noise.

FGS	No. of pulse
H	12
L	4

5. Direction of Motor Rotation Setting

The direction of rotation can be switched by the CCW pin. When CCW pin is “H” or open, the motor rotates at CCW direction. When the real direction is different from the setting, the commutation mode is 120° square wave drive (no lead angle). It is recommended to pull up CCW pin to VREG voltage when malfunctioning because of the noise.

CCW	Direction
H	CCW
L	CW

6. Hall Signal Comparator

The hall comparator provides voltage hysteresis to prevent noise malfunctions. The bias current to the hall elements should be set to the input voltage amplitude from the element, at a value higher than the minimum input voltage, $V_{HALLMIN}$. We recommend connecting a ceramic capacitor with value from 100 pF to 0.01 μF, between the differential input pins of the hall comparator. Note that the bias to hall elements must be set within the common mode input voltage range V_{HALLCM} .

7. Output Duty Pulse Width Limiter

Pulse width duty is controlled during PWM switching in order to ensure the operation of internal power transistor. The controller doesn't output pulse of less than T_{MIN} (0.8 μ s minimum), nor output a duty pulse of D_{MAX} or more. Dead time is forcibly provided to prevent internal power transistors to turn-on simultaneously in upper and lower side in gate driver output (for example, UH and UL) of each arm. This will not overlap the minimum time T_{DT} (1.6 μ s minimum). Because of this, the maximum duty of 120° square wave drive at start up is 84% (typical).

8. Phase Control Setting

The driving signal phase can be advanced to the hall signal for phase control. The lead angle is set by forcing DC voltage to the PC pin. The input voltage is converted digitally by a 6-bit A/D converter, in which internal VREG voltage is assumed to be full-scale, and the converted data is processed by a logic circuit. The lead angle can be set from 0° to +30° at 1° intervals, and updated fourth hall cycle of phase W falling edge. Phase control function only operates at 150° commutation mode. However, the controller forces PC pin voltage to ground (no lead angle) during testing mode. The VSP offset voltage (Figure 33) is buffered to PCT pin, to connect an external resistor between PCT pin and ground. The internal bias current is determined by PCT voltage and the resistor value - V_{PCT} / R_{PCT} -, and mixed to PC pin. As a result, the lead angle setting is followed with the duty control voltage, and the performance of the motor can be improved. Please select the R_{PCT} value from 50 k Ω to 200 k Ω in the range on the basis of 100 k Ω , because the PCT pin current capability is a 100 μ A or less.

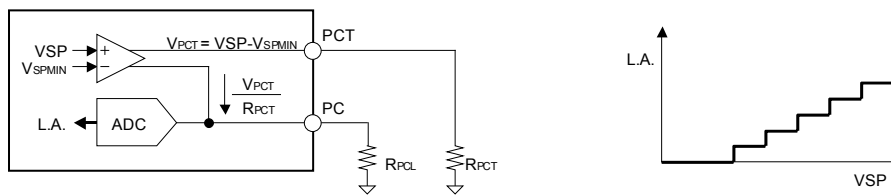

Figure 4. Phase Control Setting Example 1

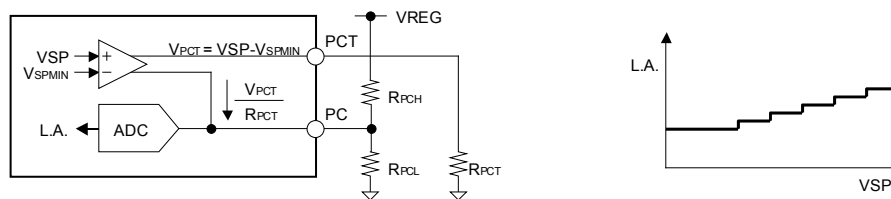

Figure 5. Phase Control Setting Example 2

9. Current Limiter (CL) Circuit and Overcurrent Protection (OCP) Circuit

The current limiter circuit can be activated by connecting a low value resistor for current detection between the output stage ground (PGND) and the controller ground (GND). When the SNS pin voltage reaches or surpasses the threshold value (V_{SNS} , 0.5V typical), the controller forces all the upper switching arm inputs low (UH, VH, WH = L, L, L), thus initiating the current limiter operation. When the SNS pin voltage swings below the ground, it is recommended to insert a resistor - 1.5 k Ω or more - between SNS pin and PGND pin to prevent malfunction. Since this limiter circuit is not a latch type, it returns to normal operation - synchronizing with the carrier frequency - once the SNS pin voltage falls below the threshold voltage. A filter is built into the overcurrent detection circuit to prevent malfunctions, and does not activate when a short pulse of less than T_{MASK} is present at the input.

When the SNS pin voltage reaches or surpasses the threshold value (V_{OVER} , 0.9V typical) because of the power fault or the short circuit except the ground fault, the gate driver outputs low to the gate of all output MOSFETs, thus initiating the overcurrent protection operation. Since this protection circuit is also not a latch type, it returns to normal operation synchronizing with the carrier frequency.

15. Bootstrap Operation

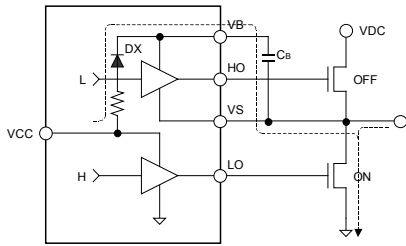

Figure 7. Charging Period

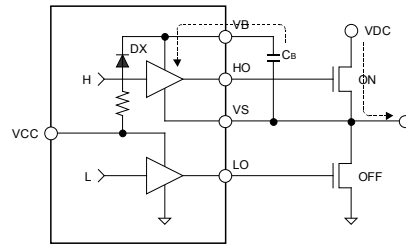

Figure 8. Discharging Period

The bootstrap is operated by the charge period and the discharge period being alternately repeated for bootstrap capacitor (CB) as shown in the figure above. In a word, this operation is repeated while the output of an external transistor is switching with synchronous rectification. Because the supply voltage of the floating driver is charged from the VCC power supply to CB through prevention of backflow diode DX, it is approximately (VCC-1V). The resistance series connection with DX has the impedance of approximately 200 Ω. Because the total gate charge is needed only by the carrier frequency in the upper switching section of 150° commutation driving, please set it after confirming actual application operation.

16. Fault Signal Output

When the controller detects either state that should be protected the overcurrent (OCP) and the over temperature (TSD), the FOB pin outputs low (open drain) and it returns to normal operation synchronizing with the carrier frequency. Even when this function is not used, the FOB pin is pull-up to the voltage of 3V or more and at least a resistor with a value 10k Ω or more. A filter is built into the fault signal input circuit to prevent malfunctions by the switching noise, and does not activate when a short pulse of less than T_{MASK} is present at the input. The time to the fault operation is the sum total of the propagation delay time of the detection circuit and the filter time, 1.6μs (typical).

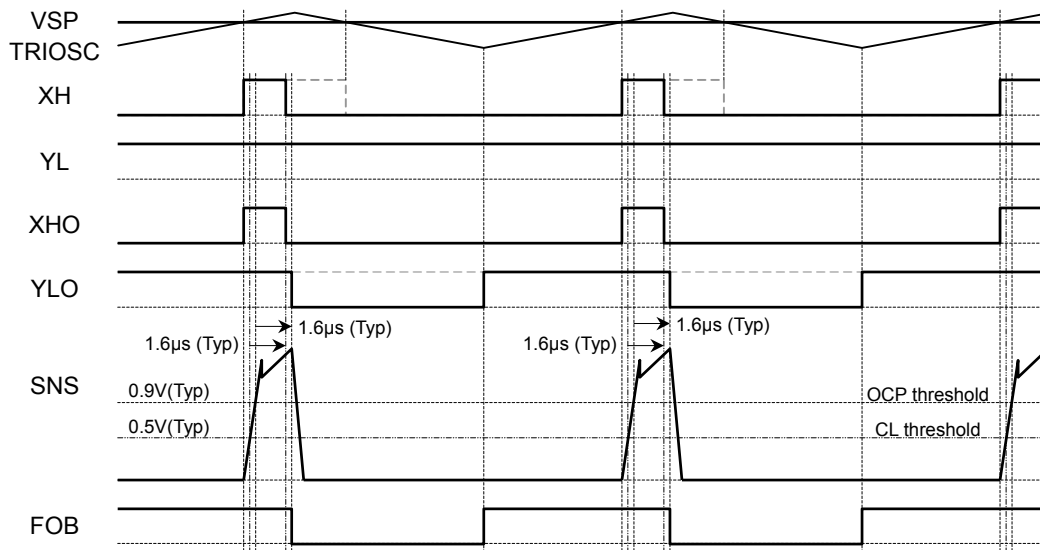

Figure 9. Fault Operation ~ OCP ~ Timing Chart

The release time from the protection operation can be changed by inserting an external capacitor. Refer to the formula below. Release time of 5ms or more is recommended.

$$t = -\ln\left(1 - \frac{2.3}{V_{REG}}\right) \cdot R \cdot C \text{ [s]}$$

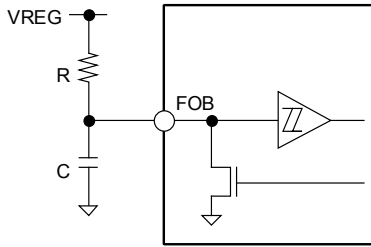

Figure 10. Release Time Setting Application Circuit

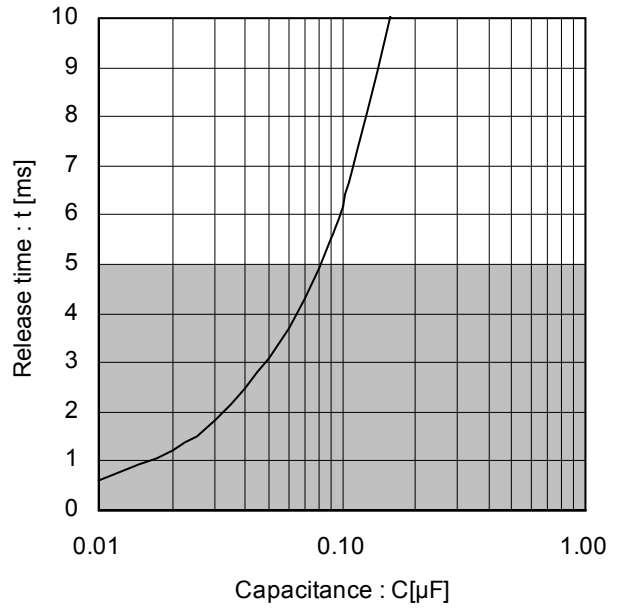

Figure 11. Release Time (Reference Data @R=100kΩ)

17. Switching Time

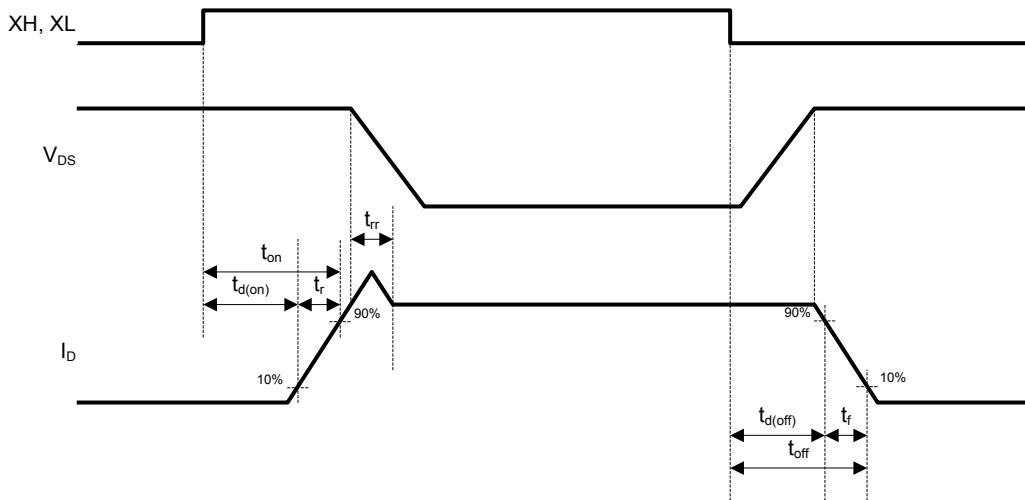

Figure 12. Switching Time Definition

Parameter	Symbol	Reference	Unit	Conditions
High Side Switching Time	$t_{dH(on)}$	790	ns	VDC=300V, VCC=15V, I _D =0.75A Inductive load
	t_{rH}	110	ns	
	t_{rrH}	200	ns	
	$t_{dH(off)}$	490	ns	
	t_{fH}	15	ns	
Low Side Switching Time	$t_{dL(on)}$	830	ns	The propagation delay time: Internal gate driver input stage to the driver IC output.
	t_{rL}	110	ns	
	t_{rrL}	160	ns	
	$t_{dL(off)}$	570	ns	
	t_{fL}	80	ns	

Timing Chart (CW)

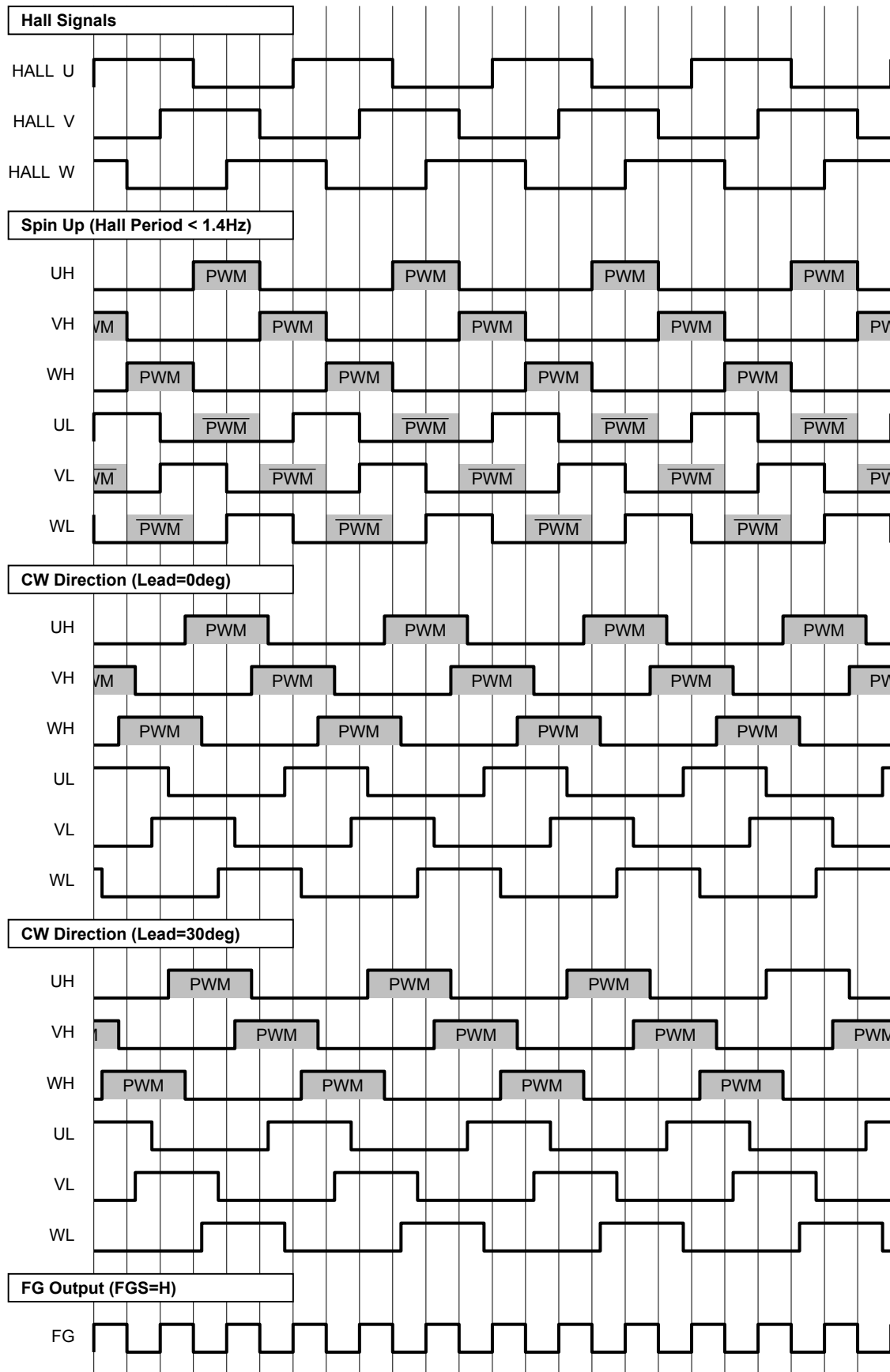

Figure 13. Timing Chart (Clockwise)

Timing Chart (CCW)

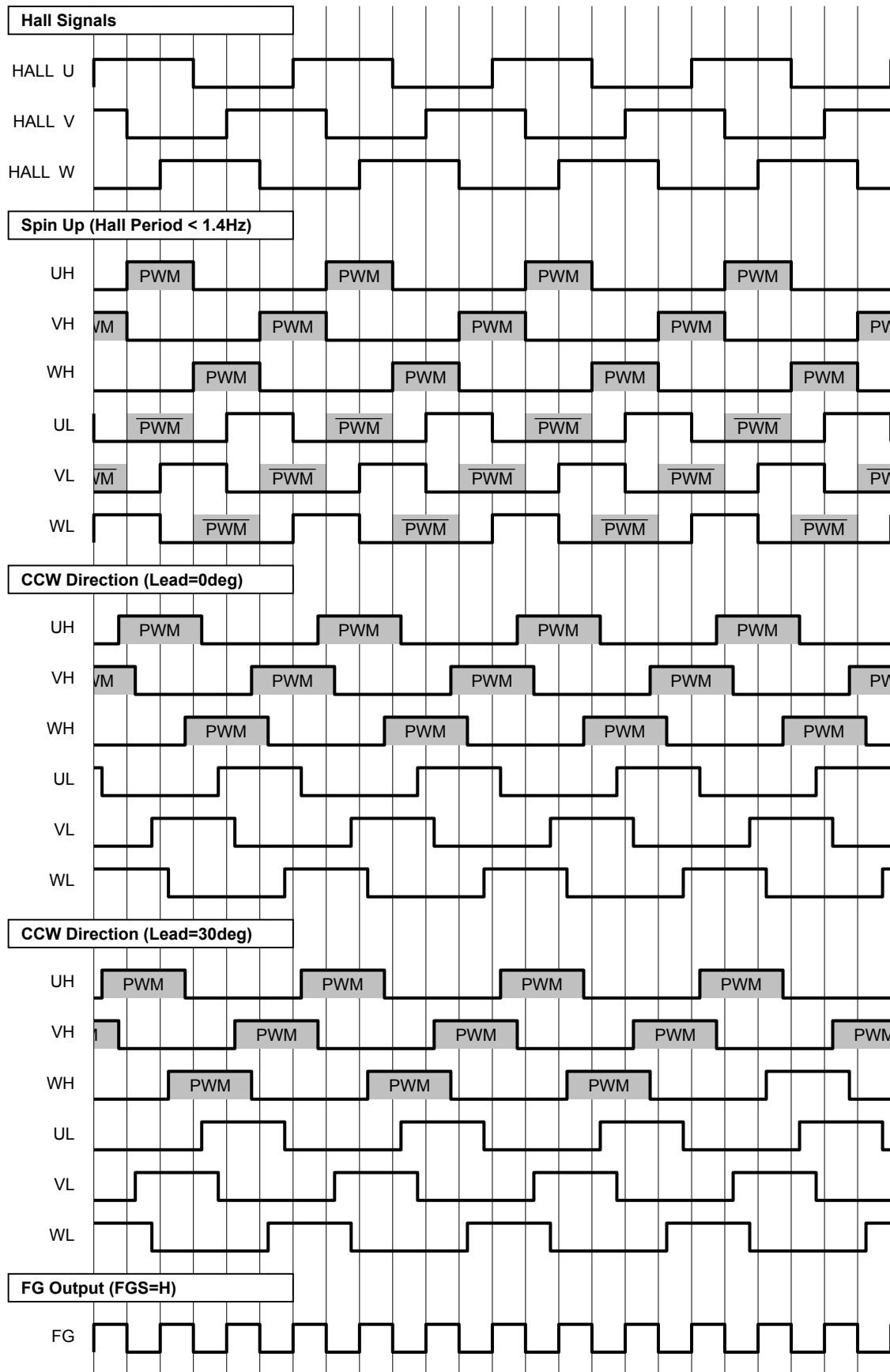

Figure 14. Timing Chart (Counter Clockwise)

Controller Outputs and Operation Mode Summary

Conditions	Detected direction	Forward (CW:U~V~W, CCW:U~W~V)		Reverse (CW:U~W~V, CCW:U~V~W)		
	Hall sensor frequency	< 1.4Hz	1.4Hz <	< 1.4Hz	1.4Hz <	
Normal operation	$V_{SP} < V_{SPMIN}$ (Duty off)	Upper and lower arm off				
	$V_{SPMIN} < V_{SP} < V_{SPMAX}$ (Control range)	120° Upper and lower switching	150° Upper switching	120° Upper and lower switching	120° Upper switching	
	$V_{SPTST} < V_{SP}$ (Testing mode)		150° Upper switching (No lead angle)			
Protect operation	Current limiter ^(Note 1)	Upper arm off			Upper and lower arm off	
	Overcurrent ^(Note 2)	Upper and lower arm off				
	TSD ^(Note 2)					
	External input ^(Note 2)					
	UVLO ^(Note 3)					
	Motor lock					
	Hall sensor abnormally	Upper and lower arm off and latch				

(Note) The controller monitors both edges of three hall sensors for detecting period.

(Note) Phase control function only operates at 150° commutation mode. However, the controller forces no lead angle during the testing mode.

(Note 1) It returns to normal operation by the carrier frequency synchronization.

(Note 2) It works together with the fault operation, and returns after the release time synchronizing with the carrier frequency.

(Note 3) It returns to normal operation after 32 cycles of the carrier oscillation period.

Absolute Maximum Ratings (Ta=25°C)

Parameter	Symbol	Ratings	Unit
Output MOSFET	V_{DSS}	600 ^(Note 1)	V
Supply Voltage	V_{DC}	-0.3 to +600 ^(Note 1)	V
Output Voltage	V_U, V_V, V_W	-0.3 to +600 ^(Note 1)	V
High Side Supply Pin Voltage	V_{BU}, V_{BV}, V_{BW}	-0.3 to +600 ^(Note 1)	V
High Side Floating Supply Voltage	$V_{BU}-V_U, V_{BV}-V_V, V_{BW}-V_W$	-0.3 to +20	V
Low Side Supply Voltage	V_{CC}	-0.3 to +20	V
Duty Control Voltage	V_{SP}	-0.3 to +20	V
All Others	V_{IO}	-0.3 to +5.5	V
Driver Outputs (DC)	$I_{OMAX(DC)}$	±1.5 ^(Note 1)	A
Driver Outputs (Pulse)	$I_{OMAX(PLS)}$	±2.5 ^(Note 1, 2)	A
Fault Signal Output	$I_{OMAX(FOB)}$	15 ^(Note 1)	mA
Power Dissipation	P_d	3.00 ^(Note 3)	W
Thermal Resistance	R_{thj-c}	15	°C/W
Operating Case Temperature	T_C	-20 to +100	°C
Storage Temperature	T_{STG}	-55 to +150	°C
Junction Temperature	T_{jmax}	150	°C

(Note) All voltages are with respect to ground.

(Note 1) Do not, however, exceed P_d or ASO.

(Note 2) $P_w \leq 10\mu s$, Duty cycle $\leq 1\%$

(Note 3) Mounted on a 70mm x 70mm x 1.6mm FR4 glass-epoxy board with less than 3% copper foil. Derated at 24mW/°C above 25°C.

Caution: Operating the IC over the absolute maximum ratings may damage the IC. The damage can either be a short circuit between pins or an open circuit between pins and the internal circuitry. Therefore, it is important to consider circuit protection measures, such as adding a fuse, in case the IC is operated over the absolute maximum ratings.

Recommended Operating Conditions (Tc=25°C)

Parameter	Symbol	Min	Typ	Max	Unit
Supply Voltage	V _{DC}	-	310	400	V
High Side Floating Supply Voltage	V _{BU-V_U} , V _{BV-V_V} , V _{BW-V_W}	13.5	15	16.5	V
Low Side Supply Voltage	V _{CC}	13.5	15	16.5	V
Bootstrap Capacitor	C _B	1.0	-	-	μF
VREG Bypass Capacitor	C _{VREG}	1.0	-	-	μF
Shunt Resistor (PGND)	R _S	0.6	-	-	Ω
Junction Temperature	T _j	-	-	125	°C

(Note) All voltages are with respect to ground.

Electrical Characteristics (Driver part, unless otherwise specified, Ta=25°C and VCC=15V)

Parameter	Symbol	Min	Typ	Max	Unit	Conditions
Power Supply						
HS Quiescence Current	I _{BBQ}	30	70	150	μA	VSP=0V, each phase
LS Quiescence Current	I _{CCQ}	0.2	0.7	1.3	mA	VSP=0V
Output MOSFET						
D-S Breakdown Voltage	V _{(BR)DSS}	600	-	-	V	I _D =1mA, VSP=0V
Leak Current	I _{DSS}	-	-	100	μA	V _{DS} =600V, VSP=0V
DC On Resistance	R _{DS(ON)}	-	2.7	3.5	Ω	I _D =0.75A
Diode Forward Voltage	V _{SD}	-	1.1	1.5	V	I _D =0.75A
Bootstrap Diode						
Leak Current	I _{LBD}	-	-	10	μA	V _{BX} =600V
Forward Voltage	V _{FBD}	1.5	1.8	2.1	V	I _{BD} =-5mA, including series-R
Series Resistance	R _{BD}	-	200	-	Ω	
Under Voltage Lock Out						
HS Release Voltage	V _{BUVH}	9.5	10.0	10.5	V	V _{BX} - V _X
HS Lockout Voltage	V _{BUVL}	8.5	9.0	9.5	V	V _{BX} - V _X

Electrical Characteristics (Controller part, unless otherwise specified, Ta=25°C and VCC=15V)

Parameter	Symbol	Min	Typ	Max	Unit	Conditions
Power Supply						
Supply Current	I _{CC}	0.8	1.7	3.0	mA	V _{SP} =0V
VREG Voltage	V _{REG}	4.5	5.0	5.5	V	I _O =-30mA
Hall Comparators						
Input Bias Current	I _{HALL}	-2.0	-0.1	2.0	μA	V _{IN} =0V
Common Mode Input	V _{HALLCM}	0	-	V _{REG} -1.5	V	
Minimum Input Level	V _{HALLMIN}	50	-	-	mV _{p-p}	
Hysteresis Voltage P	V _{HALLHY+}	5	13	23	mV	
Hysteresis Voltage N	V _{HALLHY-}	-23	-13	-5	mV	
Duty Control						
Input Bias Current	I _{SP}	15	25	35	μA	V _{IN} =5V
Duty Minimum Voltage	V _{SPMIN}	1.8	2.1	2.4	V	
Duty Maximum Voltage	V _{SPMAX}	5.1	5.4	5.7	V	
Testing Operation Range	V _{SPTST}	8.2	-	18	V	
Minimum Output Duty	D _{MIN}	-	2	-	%	F _{OSC} =20kHz
Maximum Output Duty	D _{MAX}	-	95	-	%	F _{OSC} =20kHz
Mode Switch - FGS and CCW						
Input Bias Current	I _{IN}	-70	-50	-30	μA	V _{IN} =0V
Input High Voltage	V _{INH}	3	-	V _{REG}	V	
Input Low Voltage	V _{INL}	0	-	1	V	
Fault Input/Output - FOB						
Input High Voltage	V _{FOBIH}	3	-	V _{REG}	V	
Input Low Voltage	V _{FOBIL}	0	-	1	V	
Output Low Voltage	V _{FOBOL}	0	0.07	0.60	V	I _O =5mA
Monitor Output - FG						
Output High Voltage	V _{MONH}	V _{REG} -0.40	V _{REG} -0.08	V _{REG}	V	I _O =-2mA
Output Low Voltage	V _{MONL}	0	0.02	0.40	V	I _O =2mA
Current Detection						
Input Bias Current	I _{SNS}	-30	-20	-10	μA	V _{IN} =0V
Current Limiter Voltage	V _{SNS}	0.48	0.50	0.52	V	
Overcurrent Voltage	V _{OVER}	0.84	0.90	0.96	V	
Noise Masking Time	T _{MASK}	0.8	1.0	1.2	μs	
Phase Control						
Minimum Lead Angle	P _{MIN}	-	0	1	deg	V _{PC} =0V
Maximum Lead Angle	P _{MAX}	29	30	-	deg	V _{PC} =1/2·V _{REG}
Carrier Frequency Oscillator						
Carrier Frequency	F _{OSC}	18	20	22	kHz	R _T =20kΩ
Under Voltage Lock Out						
LS Release Voltage	V _{CCUVH}	11.5	12.0	12.5	V	
LS Lockout Voltage	V _{CCUVL}	10.5	11.0	11.5	V	

Typical Performance Curves (Reference data)

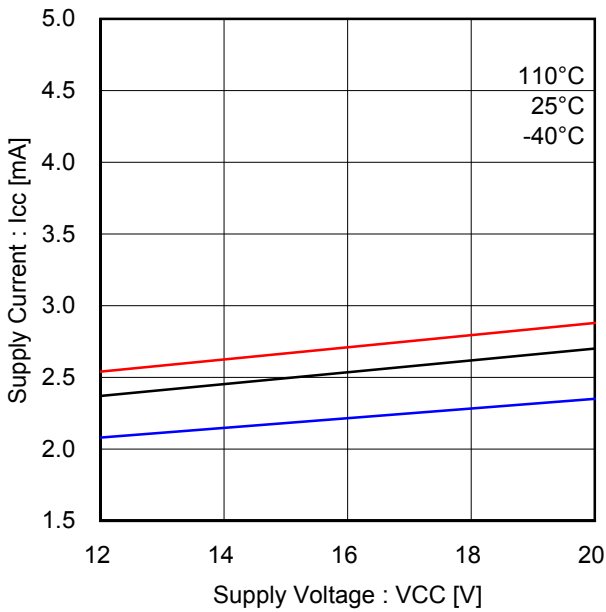

Figure 15. Quiescence Current (Low Side Drivers)

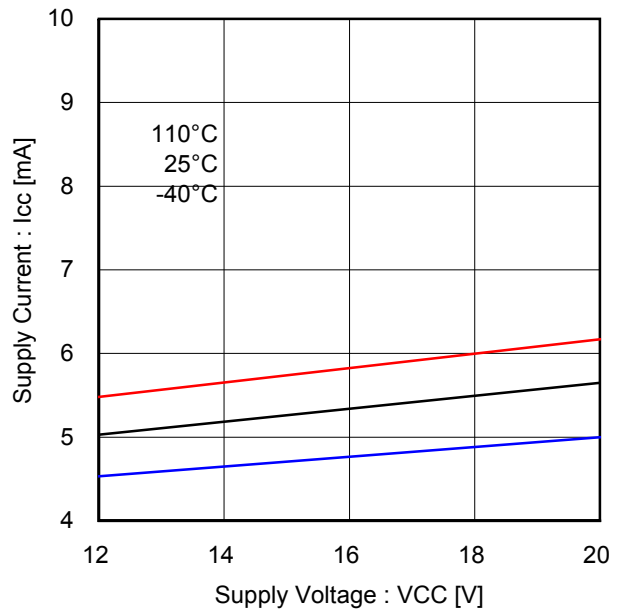

Figure 16. Low Side Drivers Operating Current (F_{PWM}: 20kHz)

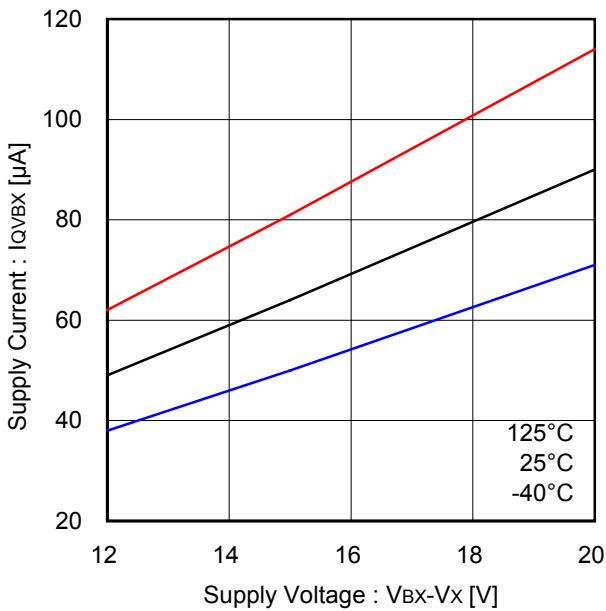

Figure 17. Quiescence Current (High Side Driver, Each Phase)

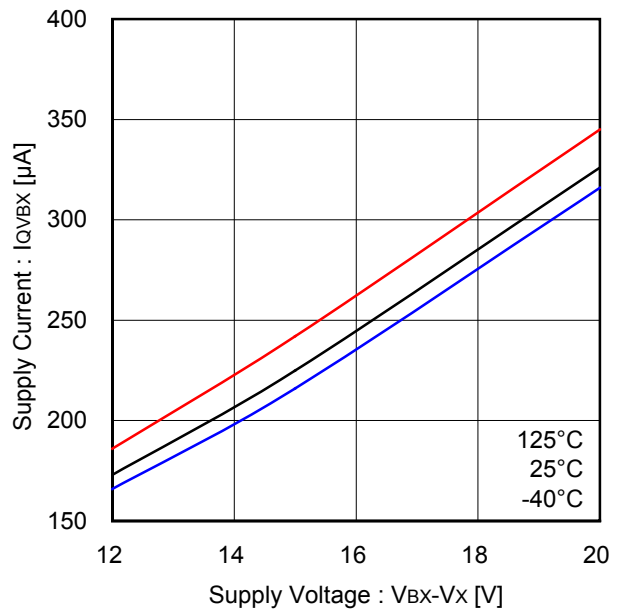

Figure 18. High Side Driver Operating Current (F_{PWM}: 20kHz, Each Phase)

Typical Performance Curves (Reference data) - Continued

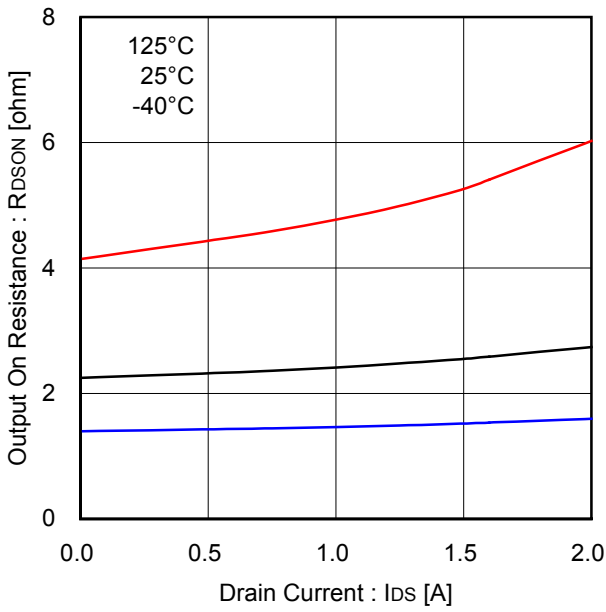

Figure 19. Output MOSFET ON Resistance

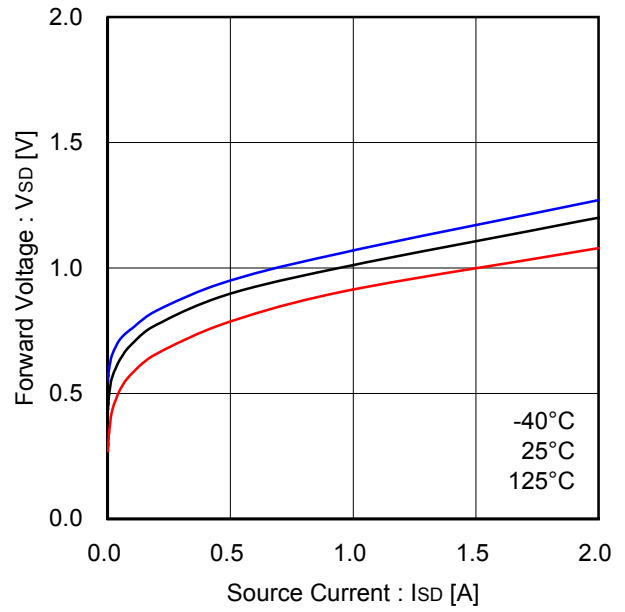

Figure 20. Output MOSFET Body Diode

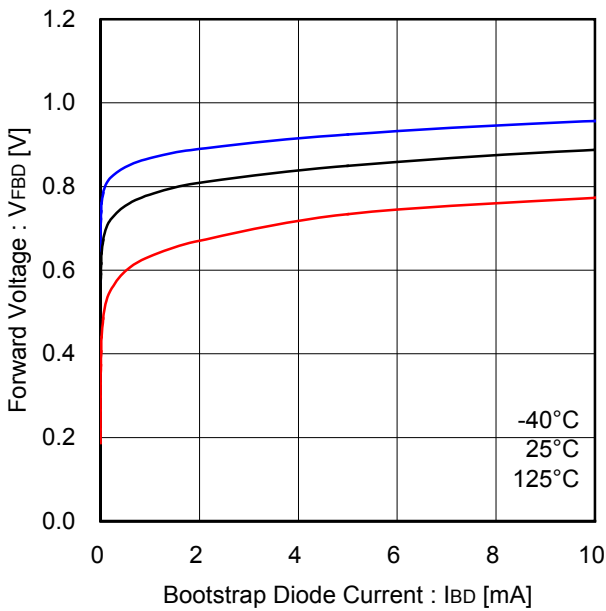

Figure 21. Bootstrap Diode Forward Voltage

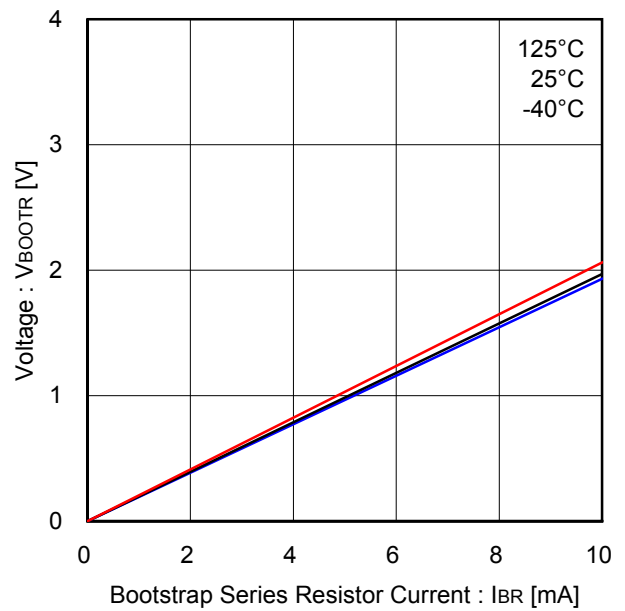

Figure 22. Bootstrap Series Resistor

Typical Performance Curves (Reference data) - Continued

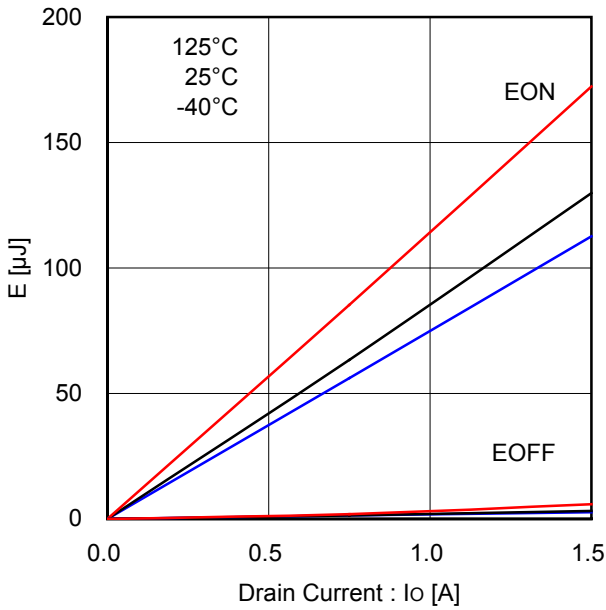

Figure 23. High Side Switching Loss (VDC=300V)

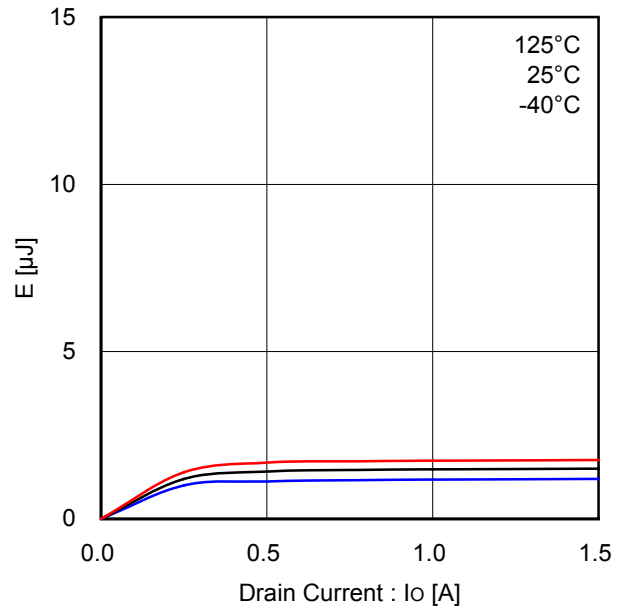

Figure 24. High Side Recovery Loss (VDC=300V)

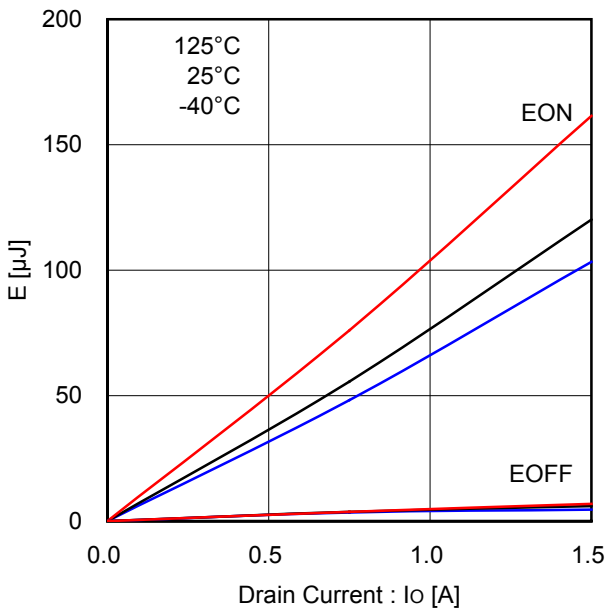

Figure 25. Low Side Switching Loss (VDC=300V)

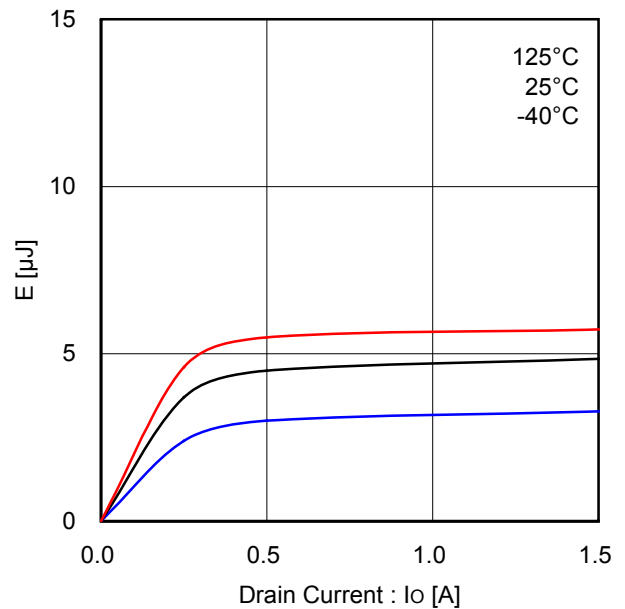

Figure 26. Low Side Recovery Loss (VDC=300V)

Typical Performance Curves (Reference data) - Continued

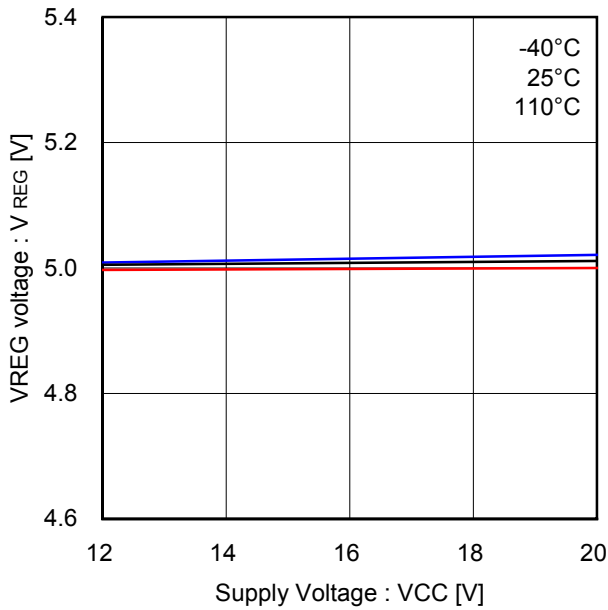

Figure 27. VREG - VCC

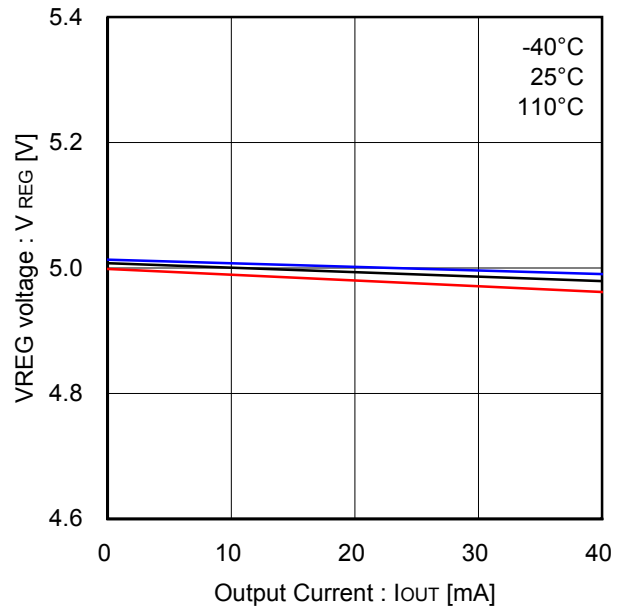

Figure 28. VREG Drive Capability

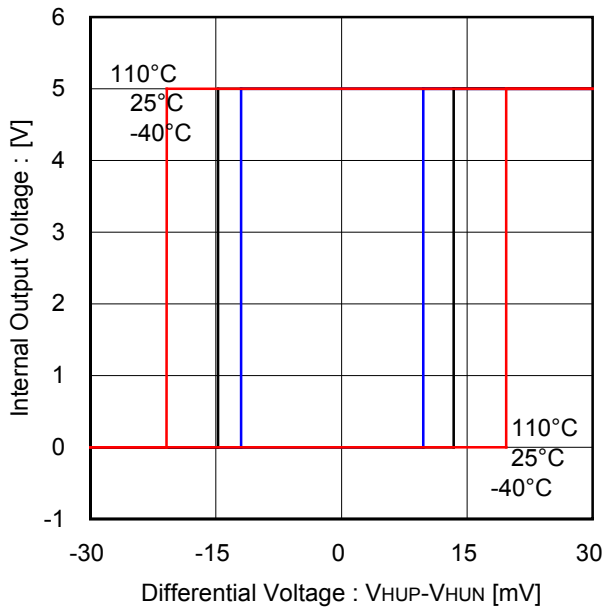

Figure 29. Hall Comparator Hysteresis Voltage

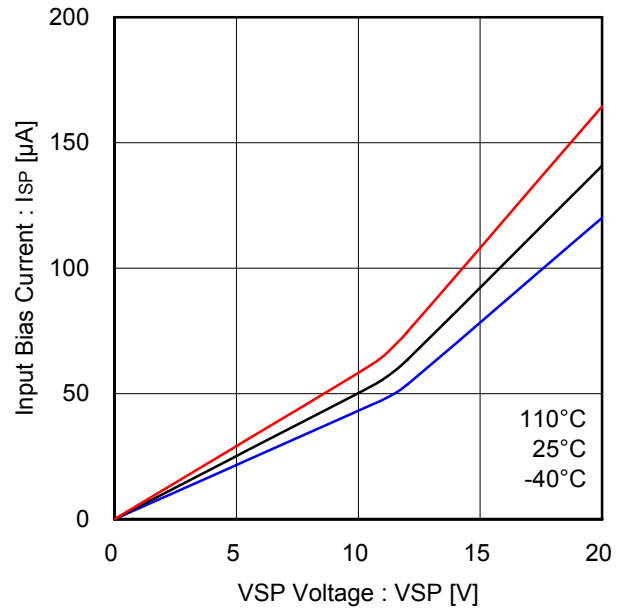

Figure 30. VSP Input Bias Current

Typical Performance Curves (Reference data) - Continued

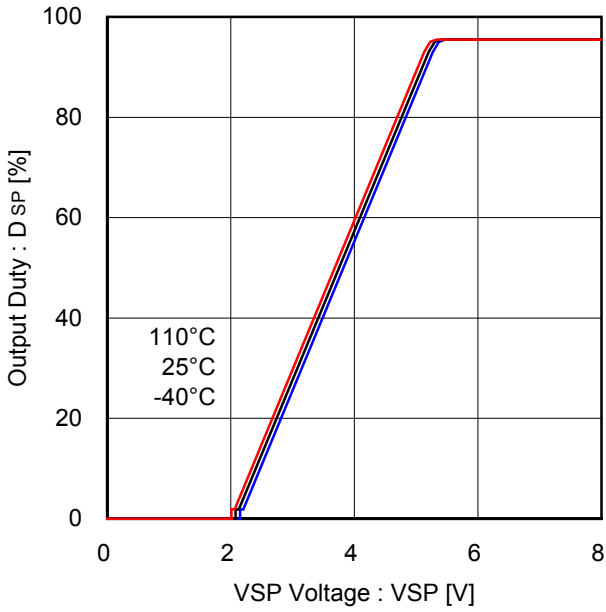

Figure 31. Output Duty - VSP Voltage

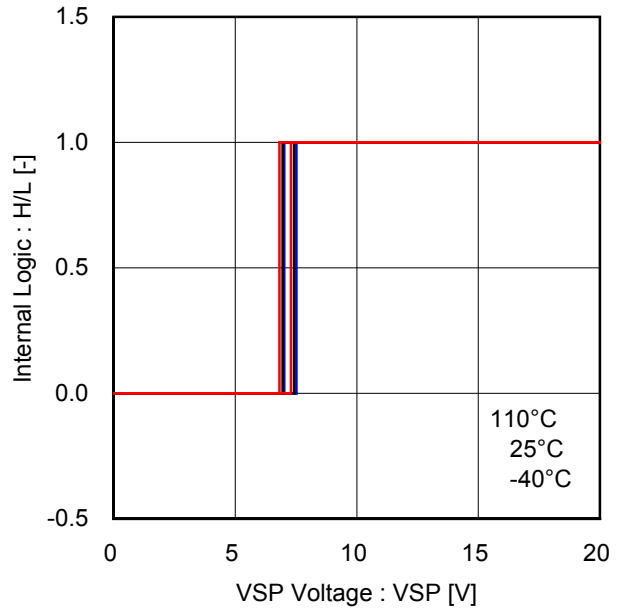

Figure 32. Testing Mode Threshold Voltage

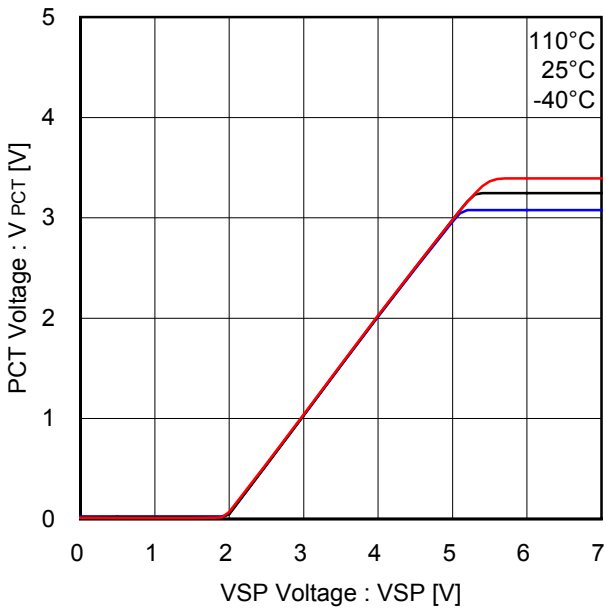

Figure 33. VSP - PCT Offset Voltage

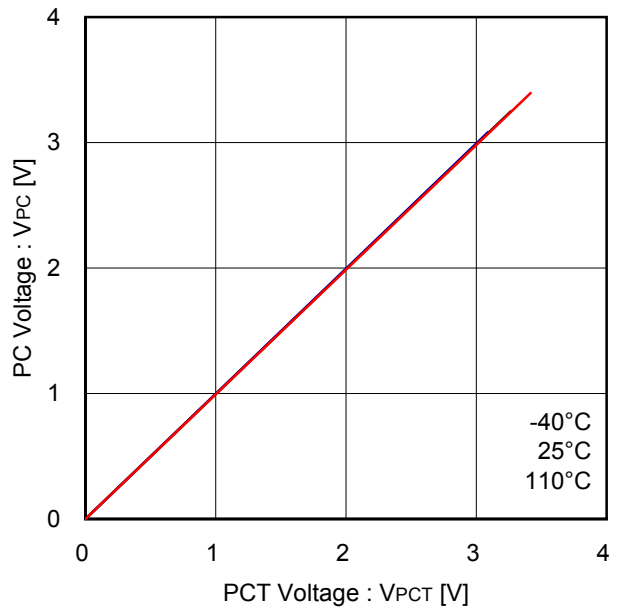

Figure 34. PCT - PC Linearity (R_{PCT}=R_{PC}=100kΩ)

Typical Performance Curves (Reference data) - Continued

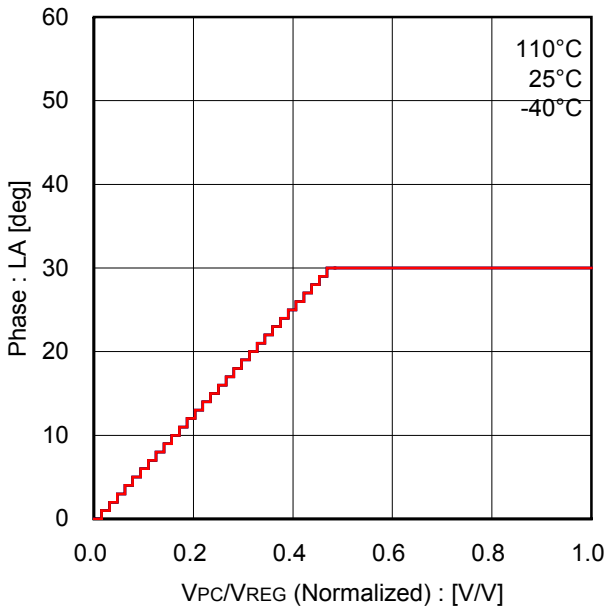

Figure 35. PC Voltage Normalized - Lead Angle

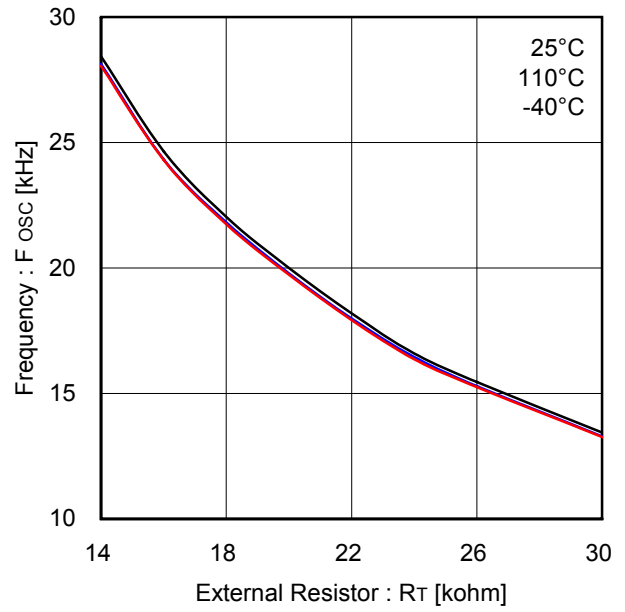

Figure 36. Carrier Frequency - RT

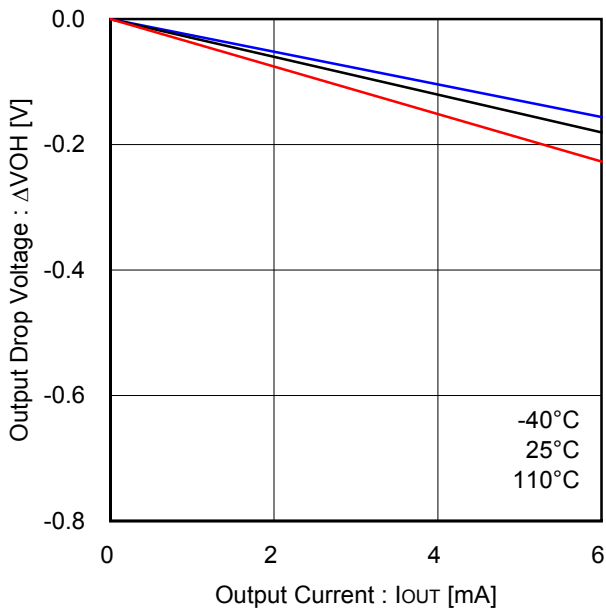

Figure 37. High Side Output Voltage (FG)

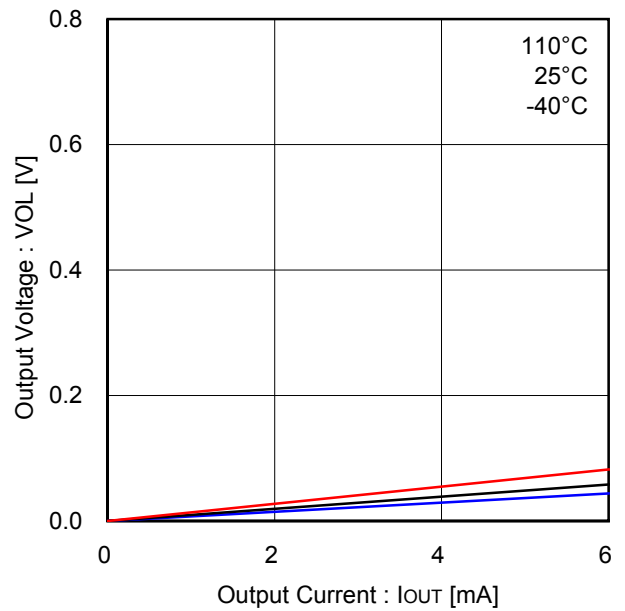

Figure 38. Low Side Output Voltage (FG)

Typical Performance Curves (Reference data) - Continued

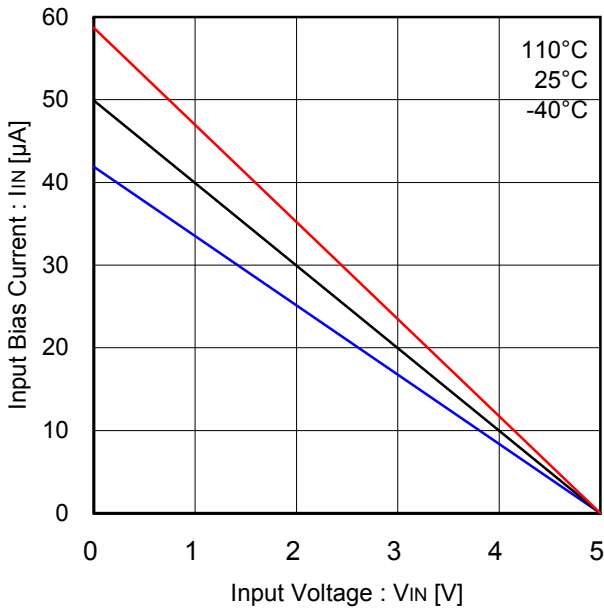

Figure 39. Input Bias Current (CCW, FGS)

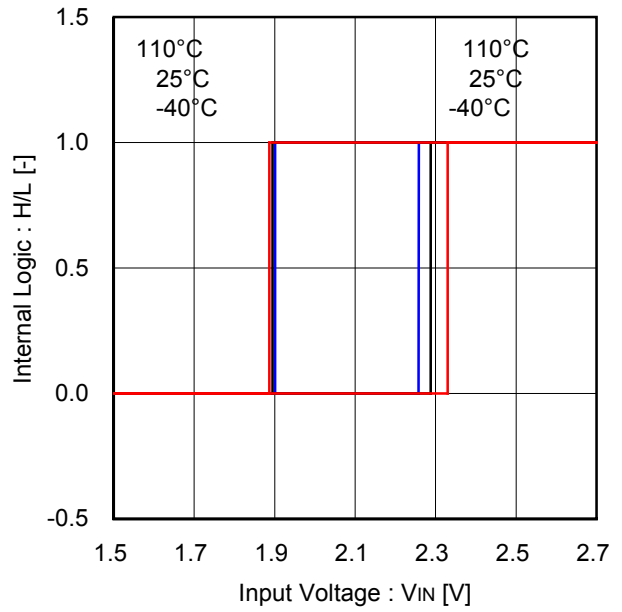

Figure 40. Input Threshold Voltage (CCW, FGS, FOB)

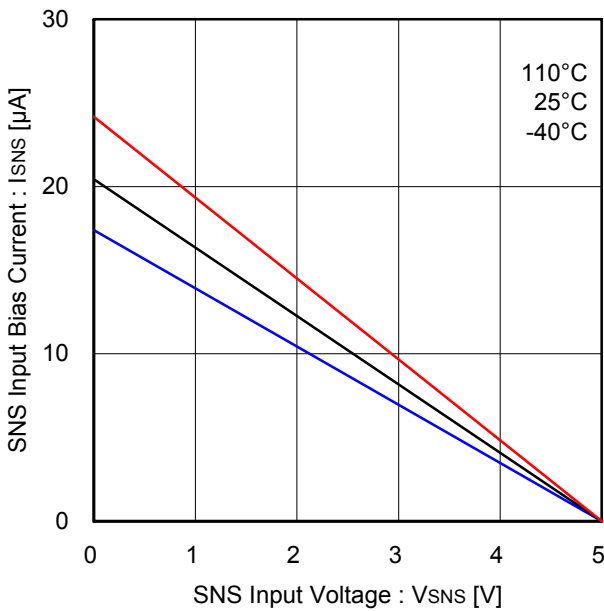

Figure 41. SNS Input Bias Current

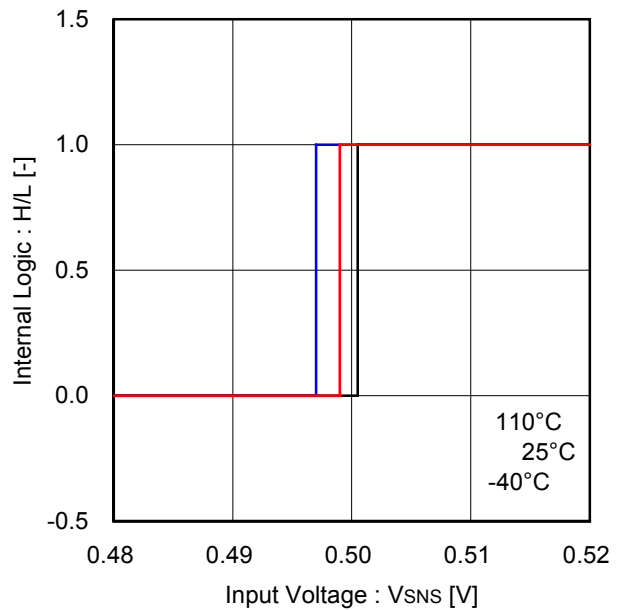

Figure 42. Current Limiter Input Threshold Voltage (SNS)

Typical Performance Curves (Reference data) - Continued

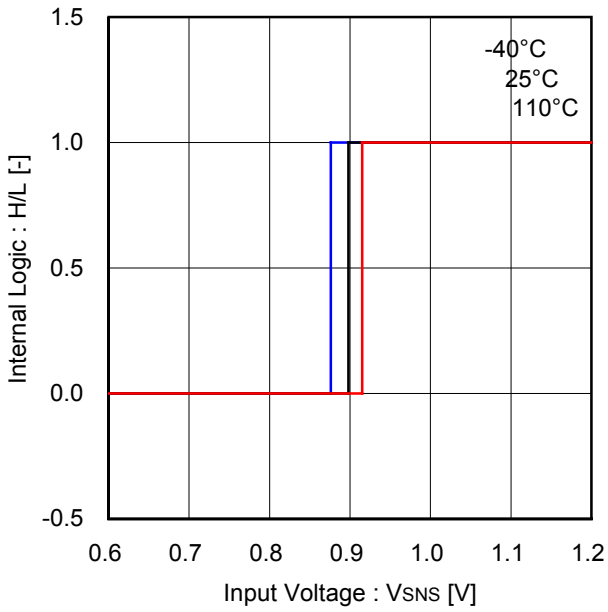

Figure 43. OCP Input Threshold Voltage (SNS)

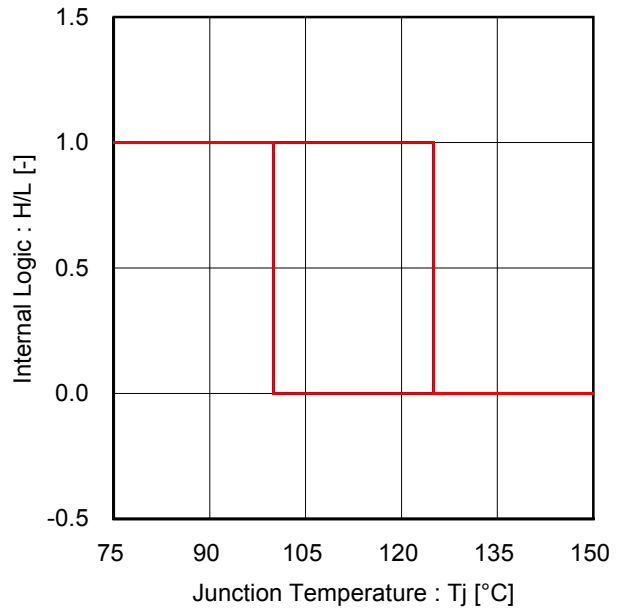

Figure 44. Thermal Shutdown

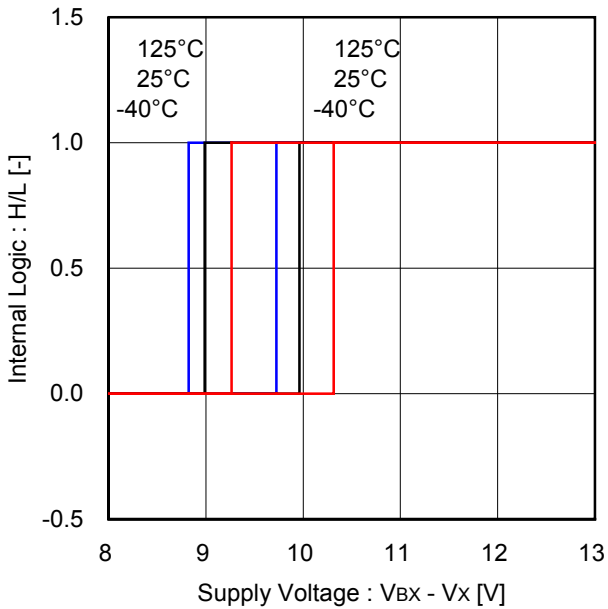

Figure 45. Under Voltage Lock Out (High Side Driver, Each Phase)

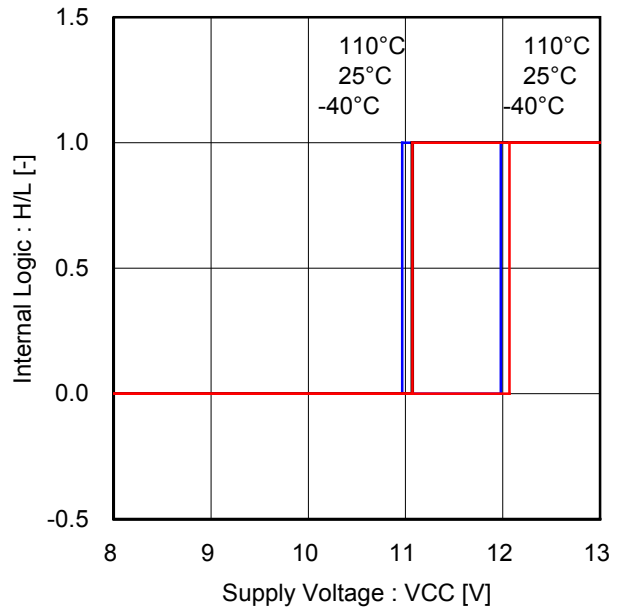

Figure 46. Under Voltage Lock Out (Low Side Drivers)

Application Example

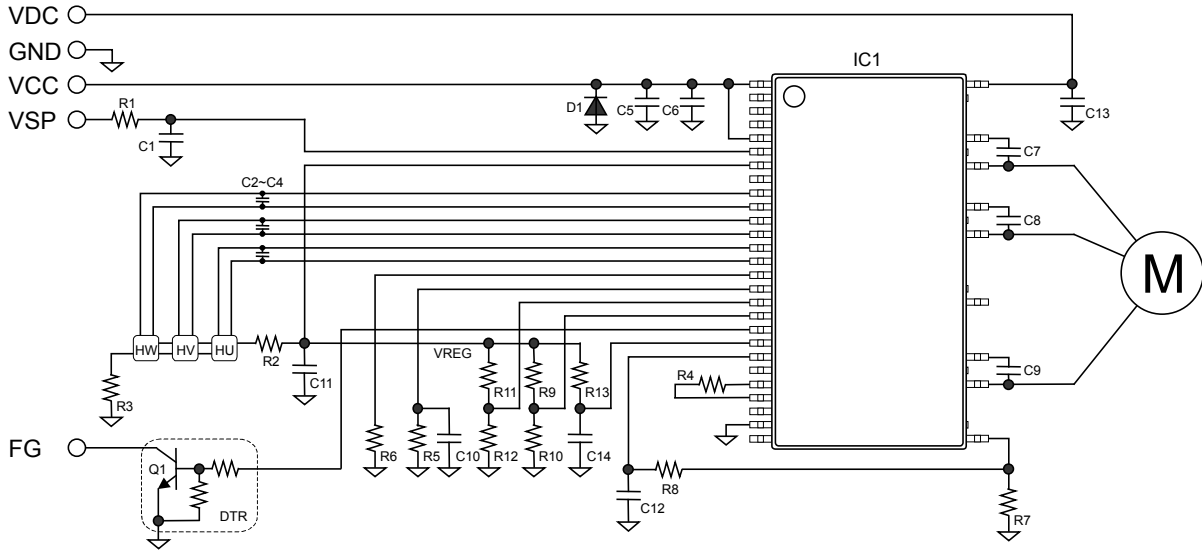

Figure 47. Application Example (150° Commutation Driver)

Parts List

Parts	Value	Manufacturer	Type	Parts	Value	Ratings	Type
IC1	-	ROHM	BM6206FS	C1	0.1μF	50V	Ceramic
R1	1kΩ	ROHM	MCR18EZPF1001	C2	2200pF	50V	Ceramic
R2	150Ω	ROHM	MCR18EZPJ151	C3	2200pF	50V	Ceramic
R3	150Ω	ROHM	MCR18EZPJ151	C4	2200pF	50V	Ceramic
R4	20kΩ	ROHM	MCR18EZPF2002	C5	10 μF	50V	Ceramic
R5	51kΩ	ROHM	MCR18EZPF5102	C6	10 μF	50V	Ceramic
R6	100kΩ	ROHM	MCR18EZPF1003	C7	2.2μF	50V	Ceramic
R7	0.6Ω	ROHM	MCR50JZHFL1R80 x 3	C8	2.2μF	50V	Ceramic
R8	10kΩ	ROHM	MCR18EZPF1002	C9	2.2μF	50V	Ceramic
R9	0Ω	ROHM	MCR18EZPJ000	C10	0.1μF	50V	Ceramic
R10	-	-	-	C11	2.2μF	50V	Ceramic
R11	0Ω	ROHM	MCR18EZPJ000	C12	100pF	50V	Ceramic
R12	-	-	-	C13	0.1μF	630V	Ceramic
R13	100kΩ	ROHM	MCR18EZPF1003	C14	0.1μF	50V	Ceramic
Q1	-	ROHM	DTC124EUA	HX	-	-	Hall elements
D1	-	ROHM	KDZ20B				

I/O Equivalence Circuits

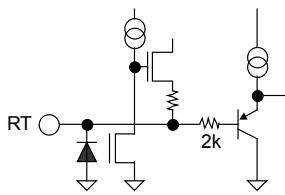

Figure 48. RT

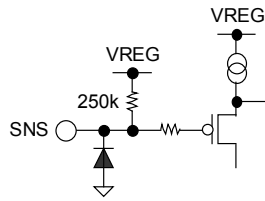

Figure 49. SNS

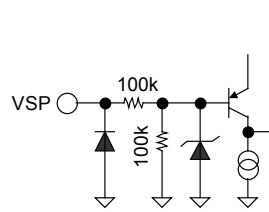

Figure 50. VSP

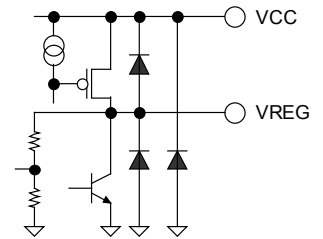

Figure 51. VREG, VCC

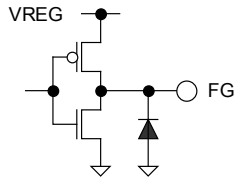

Figure 52. FG

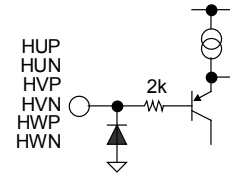

Figure 53. HXP, HXN

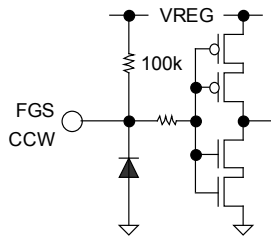

Figure 54. FGS, CCW

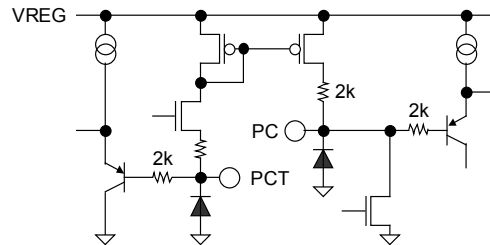

Figure 55. PC, PCT

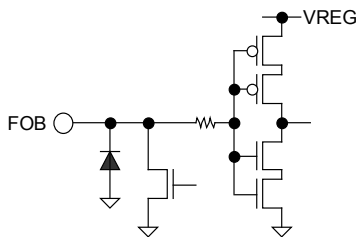

Figure 56. FOB

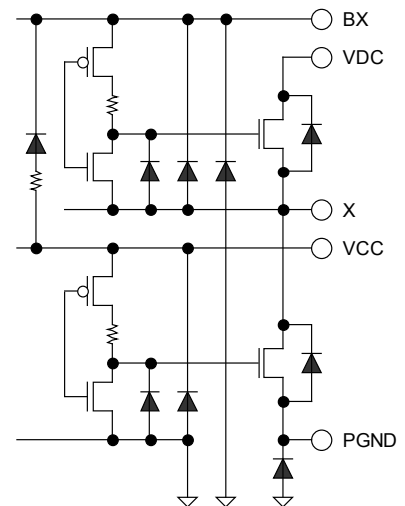

Figure 57. VCC, PGND, VDC, BX(BU/BV/BW), X(U/V/W)

Operational Notes

1. Reverse Connection of Power Supply

Connecting the power supply in reverse polarity can damage the IC. Take precautions against reverse polarity when connecting the power supply, such as mounting an external diode between the power supply and the IC's power supply terminals.

2. Power Supply Lines

Design the PCB layout pattern to provide low impedance supply lines. Separate the ground and supply lines of the digital and analog blocks to prevent noise in the ground and supply lines of the digital block from affecting the analog block. Furthermore, connect a capacitor to ground at all power supply pins. Consider the effect of temperature and aging on the capacitance value when using electrolytic capacitors.

3. Ground Voltage

Ensure that no pins are at a voltage below that of the ground pin at any time, even during transient condition. However, pins that drive inductive loads (e.g. motor driver outputs, DC-DC converter outputs) may inevitably go below ground due to back EMF or electromotive force. In such cases, the user should make sure that such voltages going below ground will not cause the IC and the system to malfunction by examining carefully all relevant factors and conditions such as motor characteristics, supply voltage, operating frequency and PCB wiring to name a few.

4. Ground Wiring Pattern

When using both small-signal and large-current ground traces, the two ground traces should be routed separately but connected to a single ground at the reference point of the application board to avoid fluctuations in the small-signal ground caused by large currents. Also ensure that the ground traces of external components do not cause variations on the ground voltage. The ground lines must be as short and thick as possible to reduce line impedance.

5. Thermal Consideration

Should by any chance the power dissipation rating be exceeded the rise in temperature of the chip may result in deterioration of the properties of the chip. The absolute maximum rating of the Pd stated in this specification is when the IC is mounted on a 70mm x 70mm x 1.6mm glass epoxy board. In case of exceeding this absolute maximum rating, increase the board size and copper area to prevent exceeding the Pd rating.

6. Recommended Operating Conditions

These conditions represent a range within which the expected characteristics of the IC can be approximately obtained. The electrical characteristics are guaranteed under the conditions of each parameter.

7. Inrush Current

When power is first supplied to the IC, it is possible that the internal logic may be unstable and inrush current may flow instantaneously due to the internal powering sequence and delays, especially if the IC has more than one power supply. Therefore, give special consideration to power coupling capacitance, power wiring, width of ground wiring, and routing of connections.

8. Operation Under Strong Electromagnetic Field

Operating the IC in the presence of a strong electromagnetic field may cause the IC to malfunction.

9. Testing on Application Boards

When testing the IC on an application board, connecting a capacitor directly to a low-impedance output pin may subject the IC to stress. Always discharge capacitors completely after each process or step. The IC's power supply should always be turned off completely before connecting or removing it from the test setup during the inspection process. To prevent damage from static discharge, ground the IC during assembly and use similar precautions during transport and storage.

10. Inter-pin Short and Mounting Errors

Ensure that the direction and position are correct when mounting the IC on the PCB. Incorrect mounting may result in damaging the IC. Avoid nearby pins being shorted to each other especially to ground, power supply and output pin. Inter-pin shorts could be due to many reasons such as metal particles, water droplets (in very humid environment) and unintentional solder bridge deposited in between pins during assembly to name a few.

11. Unused Input Pins

Input pins of an IC are often connected to the gate of a MOS transistor. The gate has extremely high impedance and extremely low capacitance. If left unconnected, the electric field from the outside can easily charge it. The small charge acquired in this way is enough to produce a significant effect on the conduction through the transistor and cause unexpected operation of the IC. So unless otherwise specified, unused input pins should be connected to the power supply or ground line.

12. Regarding the Input Pin of the IC

Do not force voltage to the input pins when the power does not supply to the IC. Also, do not force voltage to the input pins that exceed the supply voltage or in the guaranteed the absolute maximum rating value even if the power is supplied to the IC.

When using this IC, the high voltage pins VDC, BU/U, BV/V and BW/W need a resin coating between these pins. It is judged that the inter-pins distance is not enough. If any special mode in excess of absolute maximum ratings is to be implemented with this product or its application circuits, it is important to take physical safety measures, such as providing voltage-clamping diodes or fuses. And, set the output transistor so that it does not exceed absolute maximum ratings or ASO. In the event a large capacitor is connected between the output and ground, and if VCC and VDC are short-circuited with 0V or ground for any reason, the current charged in the capacitor flows into the output and may destroy the IC.

This IC contains the controller chip, P+ isolation and P substrate layers between adjacent elements in order to keep them isolated. P-N junctions are formed at the intersection of the P layers with the N layers of other elements, creating a parasitic diode or transistor. For example (refer to figure below):

When $GND > Pin A$ and $GND > Pin B$, the P-N junction operates as a parasitic diode.

When $GND > Pin B$, the P-N junction operates as a parasitic transistor.

Parasitic diodes inevitably occur in the structure of the IC. The operation of parasitic diodes can result in mutual interference among circuits, operational faults, or physical damage. Therefore, conditions that cause these diodes to operate, such as applying a voltage lower than the GND voltage to an input pin (and thus to the P substrate) should be avoided.

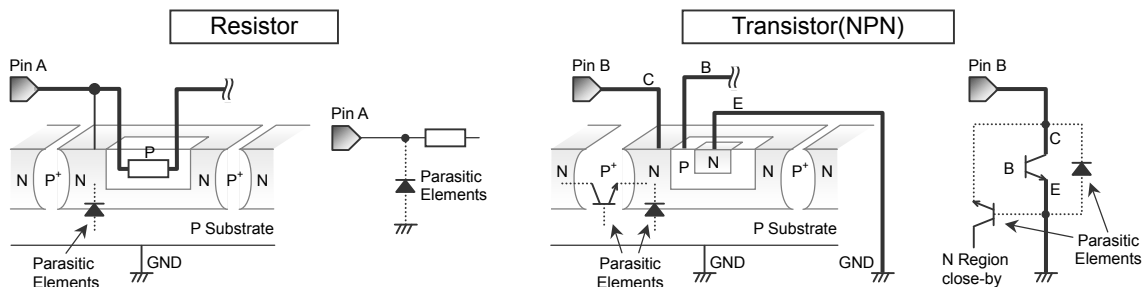

Figure A-1. Example of IC structure

13. Ceramic Capacitor

When using a ceramic capacitor, determine the dielectric constant considering the change of capacitance with temperature and the decrease in nominal capacitance due to DC bias and others.

14. Area of Safe Operation (ASO)

Operate the IC such that the output voltage, output current, and power dissipation are all within the Area of Safe Operation (ASO).

Physical Dimension, Tape and Reel Information

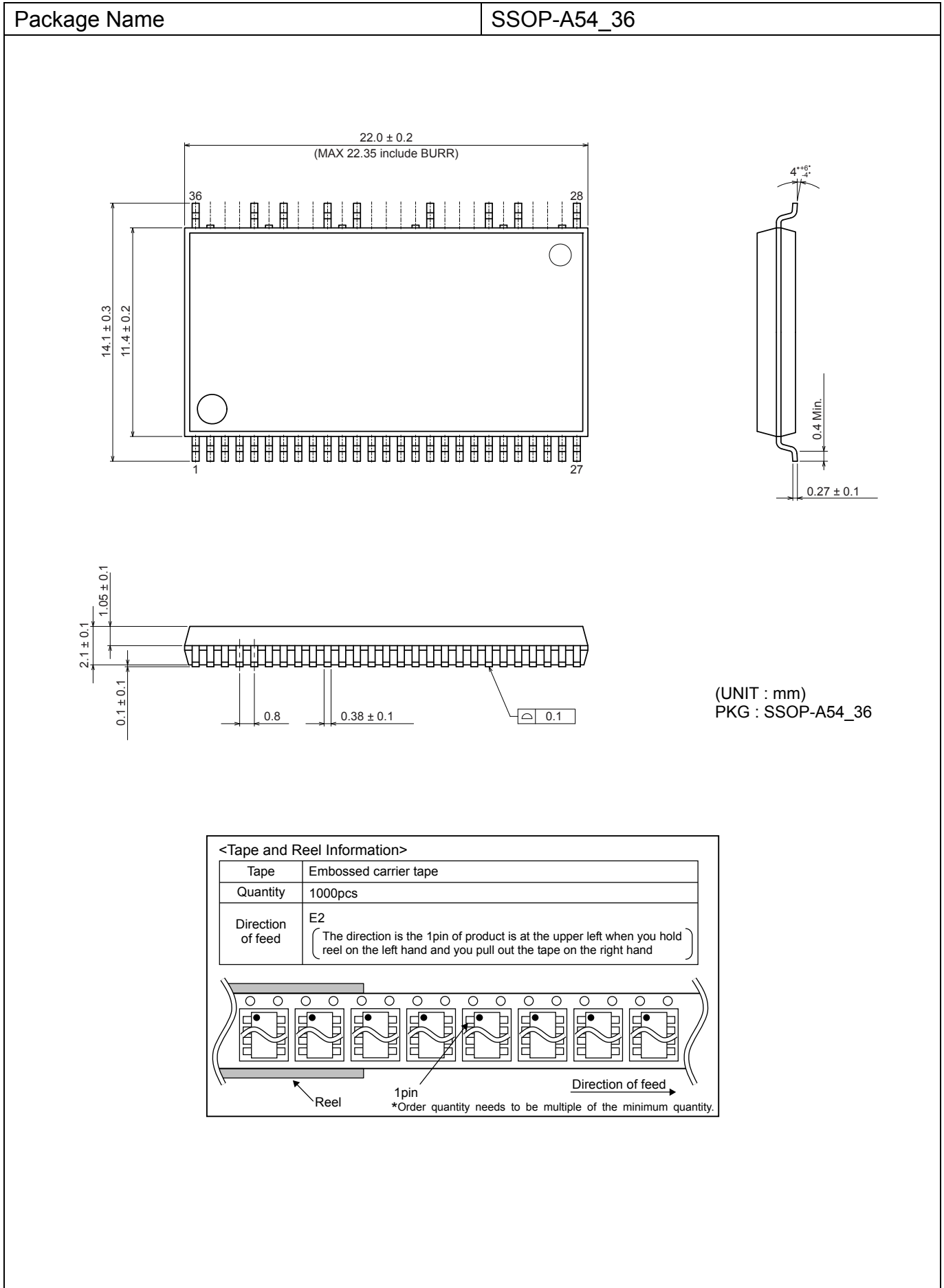

Ordering Information

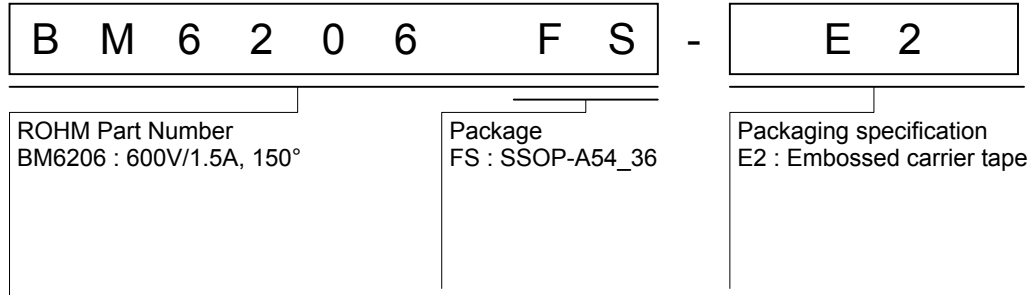

Marking Diagram

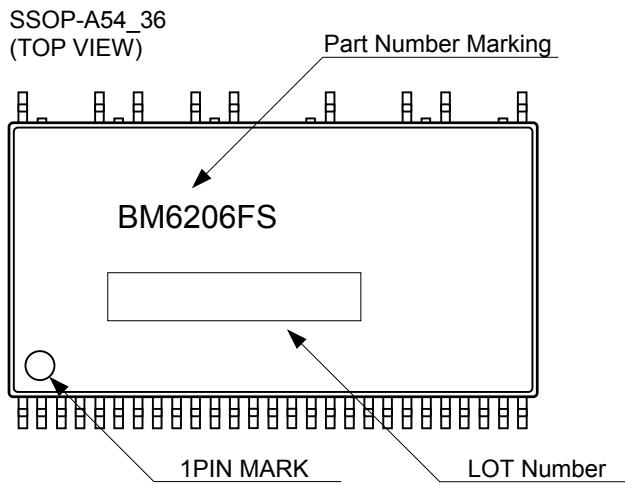

Revision History

Date	Revision	Changes
24.Dec.2014	001	New release

Notice

Precaution on using ROHM Products

- Our Products are designed and manufactured for application in ordinary electronic equipments (such as AV equipment, OA equipment, telecommunication equipment, home electronic appliances, amusement equipment, etc.). If you intend to use our Products in devices requiring extremely high reliability (such as medical equipment ^(Note 1), transport equipment, traffic equipment, aircraft/spacecraft, nuclear power controllers, fuel controllers, car equipment including car accessories, safety devices, etc.) and whose malfunction or failure may cause loss of human life, bodily injury or serious damage to property ("Specific Applications"), please consult with the ROHM sales representative in advance. Unless otherwise agreed in writing by ROHM in advance, ROHM shall not be in any way responsible or liable for any damages, expenses or losses incurred by you or third parties arising from the use of any ROHM's Products for Specific Applications.

(Note1) Medical Equipment Classification of the Specific Applications

JAPAN	USA	EU	CHINA
CLASS III	CLASS III	CLASS II b	CLASS III
CLASS IV		CLASS III	

- ROHM designs and manufactures its Products subject to strict quality control system. However, semiconductor products can fail or malfunction at a certain rate. Please be sure to implement, at your own responsibilities, adequate safety measures including but not limited to fail-safe design against the physical injury, damage to any property, which a failure or malfunction of our Products may cause. The following are examples of safety measures:
 - Installation of protection circuits or other protective devices to improve system safety
 - Installation of redundant circuits to reduce the impact of single or multiple circuit failure
- Our Products are designed and manufactured for use under standard conditions and not under any special or extraordinary environments or conditions, as exemplified below. Accordingly, ROHM shall not be in any way responsible or liable for any damages, expenses or losses arising from the use of any ROHM's Products under any special or extraordinary environments or conditions. If you intend to use our Products under any special or extraordinary environments or conditions (as exemplified below), your independent verification and confirmation of product performance, reliability, etc. prior to use, must be necessary:
 - Use of our Products in any types of liquid, including water, oils, chemicals, and organic solvents
 - Use of our Products outdoors or in places where the Products are exposed to direct sunlight or dust
 - Use of our Products in places where the Products are exposed to sea wind or corrosive gases, including Cl₂, H₂S, NH₃, SO₂, and NO₂
 - Use of our Products in places where the Products are exposed to static electricity or electromagnetic waves
 - Use of our Products in proximity to heat-producing components, plastic cords, or other flammable items
 - Sealing or coating our Products with resin or other coating materials
 - Use of our Products without cleaning residue of flux (even if you use no-clean type fluxes, cleaning residue of flux is recommended); or Washing our Products by using water or water-soluble cleaning agents for cleaning residue after soldering
 - Use of the Products in places subject to dew condensation
- The Products are not subject to radiation-proof design.
- Please verify and confirm characteristics of the final or mounted products in using the Products.
- In particular, if a transient load (a large amount of load applied in a short period of time, such as pulse. is applied, confirmation of performance characteristics after on-board mounting is strongly recommended. Avoid applying power exceeding normal rated power; exceeding the power rating under steady-state loading condition may negatively affect product performance and reliability.
- De-rate Power Dissipation (Pd) depending on Ambient temperature (Ta). When used in sealed area, confirm the actual ambient temperature.
- Confirm that operation temperature is within the specified range described in the product specification.
- ROHM shall not be in any way responsible or liable for failure induced under deviant condition from what is defined in this document.

Precaution for Mounting / Circuit board design

- When a highly active halogenous (chlorine, bromine, etc.) flux is used, the residue of flux may negatively affect product performance and reliability.
- In principle, the reflow soldering method must be used on a surface-mount products, the flow soldering method must be used on a through hole mount products. If the flow soldering method is preferred on a surface-mount products, please consult with the ROHM representative in advance.

For details, please refer to ROHM Mounting specification

Precautions Regarding Application Examples and External Circuits

1. If change is made to the constant of an external circuit, please allow a sufficient margin considering variations of the characteristics of the Products and external components, including transient characteristics, as well as static characteristics.
2. You agree that application notes, reference designs, and associated data and information contained in this document are presented only as guidance for Products use. Therefore, in case you use such information, you are solely responsible for it and you must exercise your own independent verification and judgment in the use of such information contained in this document. ROHM shall not be in any way responsible or liable for any damages, expenses or losses incurred by you or third parties arising from the use of such information.

Precaution for Electrostatic

This Product is electrostatic sensitive product, which may be damaged due to electrostatic discharge. Please take proper caution in your manufacturing process and storage so that voltage exceeding the Products maximum rating will not be applied to Products. Please take special care under dry condition (e.g. Grounding of human body / equipment / solder iron, isolation from charged objects, setting of Ionizer, friction prevention and temperature / humidity control).

Precaution for Storage / Transportation

1. Product performance and soldered connections may deteriorate if the Products are stored in the places where:
 - [a] the Products are exposed to sea winds or corrosive gases, including Cl₂, H₂S, NH₃, SO₂, and NO₂
 - [b] the temperature or humidity exceeds those recommended by ROHM
 - [c] the Products are exposed to direct sunshine or condensation
 - [d] the Products are exposed to high Electrostatic
2. Even under ROHM recommended storage condition, solderability of products out of recommended storage time period may be degraded. It is strongly recommended to confirm solderability before using Products of which storage time is exceeding the recommended storage time period.
3. Store / transport cartons in the correct direction, which is indicated on a carton with a symbol. Otherwise bent leads may occur due to excessive stress applied when dropping of a carton.
4. Use Products within the specified time after opening a humidity barrier bag. Baking is required before using Products of which storage time is exceeding the recommended storage time period.

Precaution for Product Label

QR code printed on ROHM Products label is for ROHM's internal use only.

Precaution for Disposition

When disposing Products please dispose them properly using an authorized industry waste company.

Precaution for Foreign Exchange and Foreign Trade act

Since concerned goods might be fallen under listed items of export control prescribed by Foreign exchange and Foreign trade act, please consult with ROHM in case of export.

Precaution Regarding Intellectual Property Rights

1. All information and data including but not limited to application example contained in this document is for reference only. ROHM does not warrant that foregoing information or data will not infringe any intellectual property rights or any other rights of any third party regarding such information or data.
2. ROHM shall not have any obligations where the claims, actions or demands arising from the combination of the Products with other articles such as components, circuits, systems or external equipment (including software).
3. No license, expressly or implied, is granted hereby under any intellectual property rights or other rights of ROHM or any third parties with respect to the Products or the information contained in this document. Provided, however, that ROHM will not assert its intellectual property rights or other rights against you or your customers to the extent necessary to manufacture or sell products containing the Products, subject to the terms and conditions herein.

Other Precaution

1. This document may not be reprinted or reproduced, in whole or in part, without prior written consent of ROHM.
2. The Products may not be disassembled, converted, modified, reproduced or otherwise changed without prior written consent of ROHM.
3. In no event shall you use in any way whatsoever the Products and the related technical information contained in the Products or this document for any military purposes, including but not limited to, the development of mass-destruction weapons.
4. The proper names of companies or products described in this document are trademarks or registered trademarks of ROHM, its affiliated companies or third parties.

General Precaution

1. Before you use our Products, you are requested to carefully read this document and fully understand its contents. ROHM shall not be in any way responsible or liable for failure, malfunction or accident arising from the use of any ROHM's Products against warning, caution or note contained in this document.
2. All information contained in this document is current as of the issuing date and subject to change without any prior notice. Before purchasing or using ROHM's Products, please confirm the latest information with a ROHM sales representative.
3. The information contained in this document is provided on an "as is" basis and ROHM does not warrant that all information contained in this document is accurate and/or error-free. ROHM shall not be in any way responsible or liable for any damages, expenses or losses incurred by you or third parties resulting from inaccuracy or errors of or concerning such information.