

## SSTV16859

### Dual Output 13-Bit Register with SSTL-2 Compatible I/O and Reset

#### General Description

The SSTV16859 is a dual output 13-bit register designed for use with 184 and 232 pin DDR-1 memory modules. The device has a differential input clock, SSTL-2 compatible data inputs and a LVCMOS compatible RESET input. The device has been designed to meet the JEDEC DDR module register specifications.

The device has been fabricated on an advanced sub-micron CMOS process and is designed to operate at power supplies of less than 3.6V's.

#### Features

- Compliant with DDR-1 registered module specifications
- Operates at  $2.5V \pm 0.2V V_{DD}$
- SSTL-2 compatible input structure
- SSTL-2 compliant output structure
- Differential SSTL-2 compatible clock inputs
- Low power mode when device is reset
- Industry standard 64 pin TSSOP package
- Also packaged in plastic Fine-Pitch Ball Grid Array (FBGA)

#### Ordering Code:

Order Number	Package Number	Package Description
SSTV16859G (Note 1)(Note 2)	BGA96A	96-Ball Fine-Pitch Ball Grid Array (FBGA), JEDEC MO-205, 5.5mm Wide
SSTV16859MTD (Note 2)	MTD64	64-Lead Thin Shrink Small Outline Package (TSSOP), JEDEC MO-153, 6.1mm Wide

**Note 1:** Ordering code "G" indicates Trays.

**Note 2:** Devices also available in Tape and Reel. Specify by appending the suffix letter "X" to the ordering code.

SSTV16859 Dual Output 13-Bit Register with SSTL-2 Compatible I/O and Reset

### Connection Diagrams

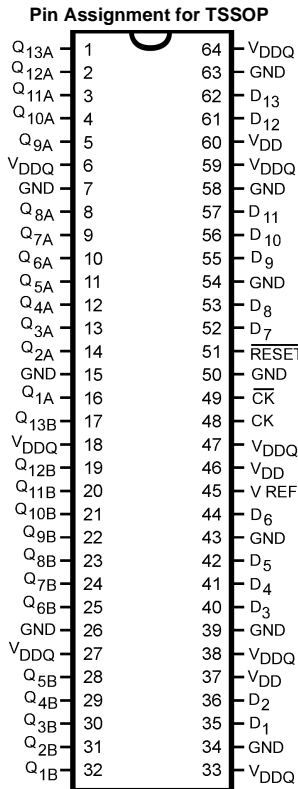

**Pin Assignment for FBGA**

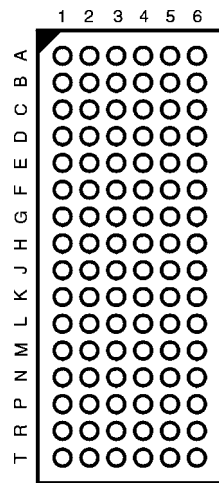

(Top Thru View)

### Pin Descriptions

Pin Name	Description
Q <sub>1A</sub> -Q <sub>13A</sub>	SSTL-2 Compatible Register Outputs
Q <sub>1B</sub> -Q <sub>13B</sub>	SSTL-2 Compatible Register Inputs
D <sub>1</sub> -D <sub>13</sub>	SSTL-2 Compatible Register Inputs
RESET	Asynchronous LVCMOS Reset Input
CK	Positive Master Clock Input
CK	Negative Master Clock Input
V <sub>REF</sub>	Voltage Reference Pin for SSTL level inputs
V <sub>DDQ</sub>	Power Supply Voltage for Output Signals
V <sub>DD</sub>	Power Supply Voltage for Inputs
NC	Electrically Isolated No Connect

### FBGA Pin Assignments

	1	2	3	4	5	6
<b>A</b>	NC	NC	NC	NC	NC	NC
<b>B</b>	Q <sub>12A</sub>	Q <sub>13A</sub>	GND	GND	NC	NC
<b>C</b>	Q <sub>10A</sub>	Q <sub>11A</sub>	GND	GND	NC	NC
<b>D</b>	Q <sub>8A</sub>	Q <sub>9A</sub>	V <sub>DDQ</sub>	V <sub>DDQ</sub>	D <sub>13</sub>	D <sub>12</sub>
<b>E</b>	Q <sub>6A</sub>	Q <sub>7A</sub>	V <sub>DDQ</sub>	V <sub>DD</sub>	D <sub>11</sub>	D <sub>10</sub>
<b>F</b>	Q <sub>4A</sub>	Q <sub>5A</sub>	V <sub>DDQ</sub>	V <sub>DD</sub>	D <sub>9</sub>	D <sub>8</sub>
<b>G</b>	Q <sub>2A</sub>	Q <sub>3A</sub>	GND	GND	D <sub>7</sub>	RESET
<b>H</b>	Q <sub>1A</sub>	Q <sub>13B</sub>	GND	GND	NC	CK
<b>J</b>	Q <sub>12B</sub>	Q <sub>11B</sub>	GND	V <sub>REF</sub>	NC	CK
<b>K</b>	Q <sub>10B</sub>	Q <sub>9B</sub>	V <sub>DDQ</sub>	V <sub>DD</sub>	NC	NC
<b>L</b>	Q <sub>8B</sub>	Q <sub>7B</sub>	V <sub>DDQ</sub>	V <sub>DD</sub>	D <sub>5</sub>	D <sub>6</sub>
<b>M</b>	Q <sub>6B</sub>	Q <sub>5B</sub>	V <sub>DDQ</sub>	V <sub>DDQ</sub>	D <sub>3</sub>	D <sub>4</sub>
<b>N</b>	Q <sub>4B</sub>	Q <sub>3B</sub>	GND	GND	D <sub>1</sub>	D <sub>2</sub>
<b>P</b>	Q <sub>2B</sub>	Q <sub>1B</sub>	GND	GND	NC	NC
<b>R</b>	NC	NC	NC	NC	NC	NC
<b>T</b>	NC	NC	NC	NC	NC	NC

### Truth Table

RESET	D <sub>n</sub>	CK	CK	Q <sub>n</sub>
L	X or Floating	X or Floating	X or Floating	L
H	L	↑	↓	L
H	H	↑	↓	H
H	X	L	H	Q <sub>n-1</sub>
H	X	H	L	Q <sub>n-1</sub>

L = Logic LOW  
H = Logic HIGH  
X = Don't Care but not floating unless noted  
↑ = LOW-to-HIGH Clock Transition  
↓ = HIGH-to-LOW Clock Transition  
Q<sub>n-1</sub> = Output Remains in Previously Clocked State

## Functional Description

The SSTV16859 is a 13-bit dual register with SSTL-2 compatible inputs and outputs. Input data is transferred to output data on the rising edge of the differential clock pair. When the  $\overline{\text{RESET}}$  signal is asserted LOW all outputs are placed into the LOW logic state and all input comparators are disabled for power savings. Output glitches are prevented by disabling the internal registers more quickly than the input comparators. When  $\overline{\text{RESET}}$  is removed, the system designer must insure the clock and data inputs to the

device are stable during the rising transition of the  $\overline{\text{RESET}}$  signal.

The SSTL-2 data inputs transition based on the value of  $V_{\text{REF}}$ .  $V_{\text{REF}}$  is a stable system reference used for setting the trip point of the input buffers of the SSTV16859 and other SSTL-2 compatible devices.

The  $\overline{\text{RESET}}$  signal is a standard CMOS compatible input and is not referenced to the  $V_{\text{REF}}$  signal.

## Logic Diagram

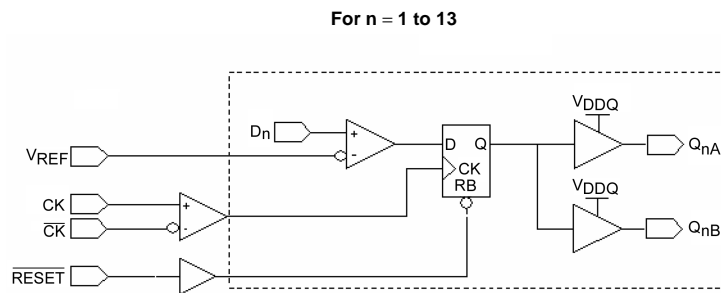

**Absolute Maximum Ratings** (Note 3)

Supply Voltage ( $V_{DDQ}$ )	-0.5V to +3.6V
Supply Voltage ( $V_{DD}$ )	-0.5V to +3.6V
Reference Voltage ( $V_{REF}$ )	-0.5V to +3.6V
Input Voltage ( $V_I$ )	-0.5V to $V_{DD} + 0.5V$
Output Voltage ( $V_O$ )	
Outputs Active (Note 4)	-0.5V to $V_{DDQ} + 0.5V$
DC Input Diode Current ( $I_{IK}$ )	
$V_I < 0V$	-50 mA
$V_I > V_{DD}$	+50 mA
DC Output Diode Current ( $I_{OK}$ )	
$V_O < 0V$	-50 mA
$V_O > V_{DDQ}$	+50 mA
DC Output Source/Sink Current ( $I_{OH}/I_{OL}$ )	±50 mA
DC $V_{DD}$ or Ground Current per Supply Pin ( $I_{DD}$ or Ground)	±100 mA
Storage Temperature Range ( $T_{stg}$ )	-65°C to +150°C
ESD (Human Body Model)	≥ 7000V

**Recommended Operating Conditions** (Note 5)

Power Supply ( $V_{DDQ}$ )	2.3V to 2.7V
Power Supply ( $V_{DD}$ )	
Operating Range	$V_{DDQ}$ to 2.7V
Reference Supply ( $V_{REF} = V_{DDQ}/2$ )	1.15 to 1.35
Termination Voltage ( $V_{TT}$ )	$V_{REF} \pm 40$ mV
Input Voltage	0 to $V_{DD}$
Output Voltage ( $V_O$ )	
Output in Active States	0V to $V_{DDQ}$
Output Current $I_{OH}/I_{OL}$	
$V_{DD} = 2.3V$ to 2.7V	±20 mA
Free Air Operating Temperature ( $T_A$ )	0°C to +70°C

**Note 3:** The "Absolute Maximum Ratings" are those values beyond which the safety of the device cannot be guaranteed. The device should not be operated at these limits. The parametric values defined in the "Electrical Characteristics" table are not guaranteed at the absolute maximum ratings. The "Recommended Operating Conditions" table will define the conditions for actual device operation.

**Note 4:** IO Absolute Maximum Rating must be observed.

**Note 5:** The  $\overline{RESET}$  input of the device must be held at  $V_{DD}$  or GND to ensure proper device operation. The differential inputs must not be floating, unless  $\overline{RESET}$  is asserted LOW.

**DC Electrical Characteristics** ( $2.3V \leq V_{DD} \leq 2.7V$ )

Symbol	Parameter	Conditions	$V_{DD}$ (V)	Min	Typ	Max	Units
$V_{IKL}$	Input LOW Clamp Voltage	$I_I = -18$ mA	2.3			-1.2	V
$V_{IKH}$	Input HIGH Clamp Voltage	$I_I = +18$ mA	2.3			3.5	V
$V_{IH-AC}$	AC HIGH Level Input Voltage	Data Inputs		$V_{REF} + 310$ mV			V
$V_{IL-AC}$	AC LOW Level Input Voltage	Data Inputs				$V_{REF} - 310$ mV	V
$V_{IH-DC}$	DC HIGH Level Input Voltage	Data Inputs		$V_{REF} + 150$ mV			V
$V_{IL-DC}$	DC LOW Level Input Voltage	Data Inputs				$V_{REF} - 150$ mV	V
$V_{IH}$	HIGH Level Input Voltage	$\overline{RESET}$		1.7			V
$V_{IL}$	LOW Level Input Voltage	$\overline{RESET}$				0.7	V
$V_{ICR}$	Common Mode Input Voltage Range	CK, $\overline{CK}$		0.97		1.53	V
$V_{I(PP)}$	Peak to Peak Input Voltage	CK, $\overline{CK}$		360			mV
$V_{OH}$	HIGH Level Output Voltage	$I_{OH} = -100$ $\mu$ A $I_{OH} = -16$ mA	2.3 to 2.7 2.3	$V_{DD} - 0.2$ 1.95			V
$V_{OL}$	LOW Level Output Voltage	$I_{OL} = 100$ $\mu$ A $I_{OL} = 16$ mA	2.3 to 2.7 2.3			0.2 0.35	V
$I_I$	Input Leakage Current	$V_I = V_{DD}$ or GND	2.7			±5.0	$\mu$ A
$I_{DD}$	Static Standby	$\overline{RESET} = GND, I_O = 0$	2.7			10	$\mu$ A
	Static Operating	$\overline{RESET} = V_{DD}, I_O = 0$ $V_I = V_{IH(AC)}$ or $V_{IL(AC)}$				25	mA
$I_{DD}$	Dynamic Operating Current Clock Only	$\overline{RESET} = V_{DD}, I_O = 0$ $V_I = V_{IH(AC)}$ or $V_{IL(AC)}$ CK, $\overline{CK}$ Duty Cycle 50%	2.7			120	$\mu$ A/MHz
	Dynamic Operating Current per Data Input	$\overline{RESET} = V_{DD}, I_O = 0$ $V_I = V_{IH(AC)}$ or $V_{IL(AC)}$ CK, $\overline{CK}$ Duty Cycle 50% Data Input = ½ Clock Rate 50% Duty Cycle				15	$\mu$ A/MHz

**DC Electrical Characteristics** (Continued)

Symbol	Parameter	Conditions	V <sub>DD</sub> (V)	Min	Typ	Max	Units
R <sub>OH</sub>	Output HIGH On Resistance	I <sub>OH</sub> = -20 mA	2.3 to 2.7	7		20	Ω
R <sub>OL</sub>	Output LOW On Resistance	I <sub>OL</sub> = 20 mA	2.3 to 2.7	7		20	Ω
R <sub>OA</sub>	R <sub>OH</sub> - R <sub>OL</sub>	I <sub>O</sub> = 20 mA, T <sub>A</sub> = 25°C	2.5			4	Ω

**AC Electrical Characteristics** (Note 6)

Symbol	Parameter	T <sub>A</sub> = 0°C to +70°C, C <sub>L</sub> = 30 pF, R <sub>L</sub> = 50Ω			Units
		V <sub>DD</sub> = 2.5V ± 0.2V; V <sub>DDQ</sub> = 2.5V ± 0.2V			
		Min	Typ	Max	
f <sub>MAX</sub>	Maximum Clock Frequency	200			MHz
t <sub>W</sub>	Pulse Duration, CK, $\overline{\text{CK}}$ HIGH or LOW (Figure 2)	2.5			ns
t <sub>ACT</sub> (Note 7)	Differential Inputs Activation Time, data inputs must be LOW after $\overline{\text{RESET}}$ HIGH (Figure 3)	22			ns
t <sub>INACT</sub> (Note 7)	Differential Inputs De-activation Time, data and clock inputs must be held at valid levels (not floating) after $\overline{\text{RESET}}$ LOW	22			ns
t <sub>S</sub>	Setup Time, Fast Slew Rate (Note 8)(Note 9) (Figure 5)	0.75			ns
	Setup Time, Slow Slew Rate (Note 9)(Note 10) (Figure 5)	0.9			
t <sub>H</sub>	Hold Time, Fast Slew Rate (Note 8)(Note 10) (Figure 5)	0.75			ns
	Hold Time, Slow Slew Rate (Note 9)(Note 10) (Figure 5)	0.9			
t <sub>REM</sub>	Reset Removal Time (Figure 7)	10			ns
t <sub>PHL</sub> , t <sub>PLH</sub>	Propagation Delay CK, $\overline{\text{CK}}$ to Q <sub>n</sub> (Figure 4)	1.1		2.8	ns
t <sub>PHL</sub>	Propagation Delay $\overline{\text{RESET}}$ to Q <sub>n</sub> (Figure 6)			5.0	ns

**Note 6:** Refer to Figure 1 through Figure 7.

**Note 7:** This parameter is not production tested.

**Note 8:** For data signal input slew rate  $\geq 1$  V/ns.

**Note 9:** For data signal input slew rate  $\geq 0.5$  V/ns and  $< 1$  V/ns.

**Note 10:** For CK,  $\overline{\text{CK}}$  signals input slew rates are  $\geq 1$  V/ns.

**Capacitance** (Note 11)

Symbol	Parameter	Min	Typ	Max	Units	Conditions
C <sub>IN</sub>	Data Pin Input Capacitance	2.2		3.2	pF	V <sub>DD</sub> = 2.5V, V <sub>I</sub> = V <sub>REF</sub> ± 310 mV
	CK, $\overline{\text{CK}}$ - Input Capacitance	2.2		3.2	pF	V <sub>DD</sub> = 2.5V, V <sub>ICR</sub> = 1.25, V <sub>I(PP)</sub> = 360 mV
	$\overline{\text{RESET}}$	2.3		3.3	pF	V <sub>DD</sub> = 2.5V, V <sub>I</sub> = V <sub>DD</sub> or GND

**Note 11:** T<sub>A</sub> = +25°C, f = 1 MHz, Capacitance is characterized but not tested.

**AC Loading and Waveforms** (See Notes A through F below)

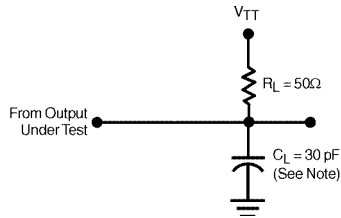

Note:  $C_L$  includes probe and jig capacitance

**FIGURE 1. AC Test Circuit**

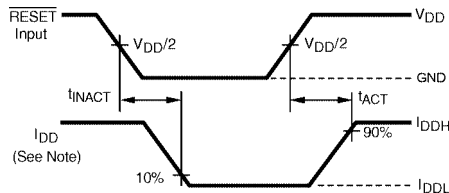

Note:  $I_{DD}$  tested with clock and data inputs held at  $V_{DD}$  or GND, and  $I_O = 0$  mA.

**FIGURE 3. Voltage and Current Waveforms Inputs Active and Inactive Times**

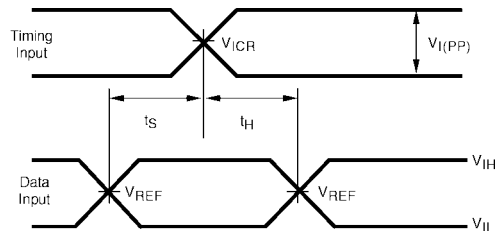

**FIGURE 5. Voltage Waveforms - Setup and Hold Times**

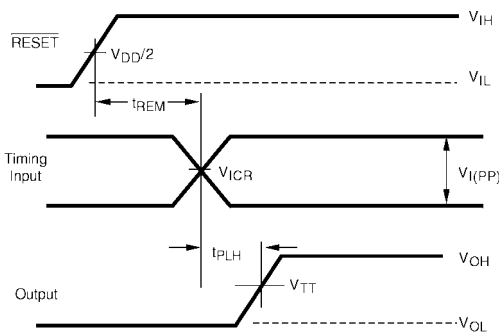

**FIGURE 7. Voltage Waveforms - RESET Removal Delay Times**

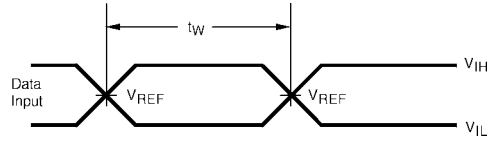

**FIGURE 2. Voltage Waveforms - Pulse Duration**

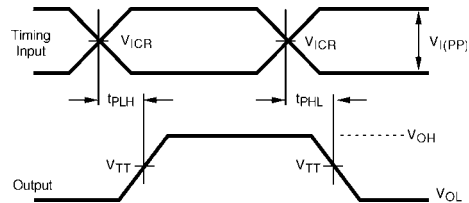

**FIGURE 4. Voltage Waveforms - Propagation Delay Times**

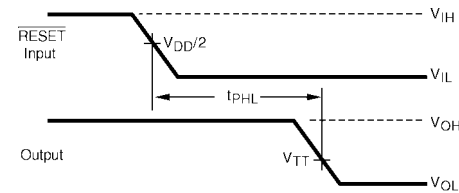

**FIGURE 6. Voltage Waveforms - RESET Propagation Delay Times**

**Note A:** All input pulses are supplied by generators having the following characteristics:

PRR  $\leq$  10 MHz,  $Z_0 = 50\Omega$ , input slew rate =  $1V/ns \pm 20\%$  (unless otherwise specified).

**Note B:** The outputs are measured one at a time with one transition per measurement.

**Note C:**  $V_{TT} = V_{REF} = V_{DD}/2$ .

**Note D:**  $V_{IH} = V_{REF} + 310$  mV (AC voltage levels) for differential inputs.  $V_{IH} = V_{DD}$  for LVCMOS input.

**Note E:**  $V_{IL} = V_{REF} - 310$  mV (AC voltage levels) for differential inputs.  $V_{IL} = GND$  for LVCMOS input.

**Note F:** Removal time ( $t_{REM}$ ) is tested with one data input held active HIGH. The propagation time from CK to the corresponding output must meet valid timing specifications for the measurement to be accurate.

**Physical Dimensions** inches (millimeters) unless otherwise noted

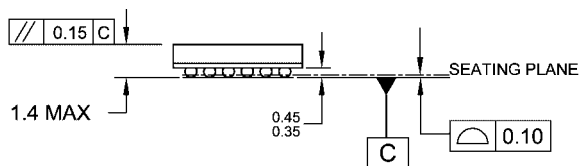
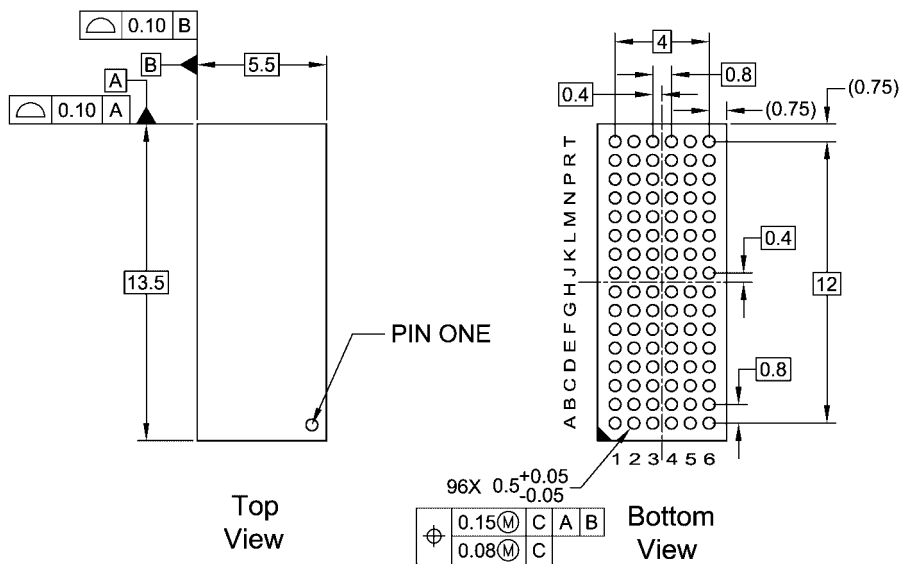

**NOTES:**

- A. THIS PACKAGE CONFORMS TO JEDEC MO-205
- B. ALL DIMENSIONS IN MILLIMETERS
- C. LAND PATTERN RECOMMENDATION: NSMD (Non Solder Mask Defined)  
.35MM DIA PADS WITH A SOLDERMASK OPENING OF .45MM CONCENTRIC TO PADS
- D. DRAWING CONFORMS TO ASME Y14.5M-1994

BGA96ArevE

**96-Ball Fine-Pitch Ball Grid Array (FBGA), JEDEC MO-205, 5.5mm Wide  
Package Number BGA96A**

**Physical Dimensions** inches (millimeters) unless otherwise noted (Continued)

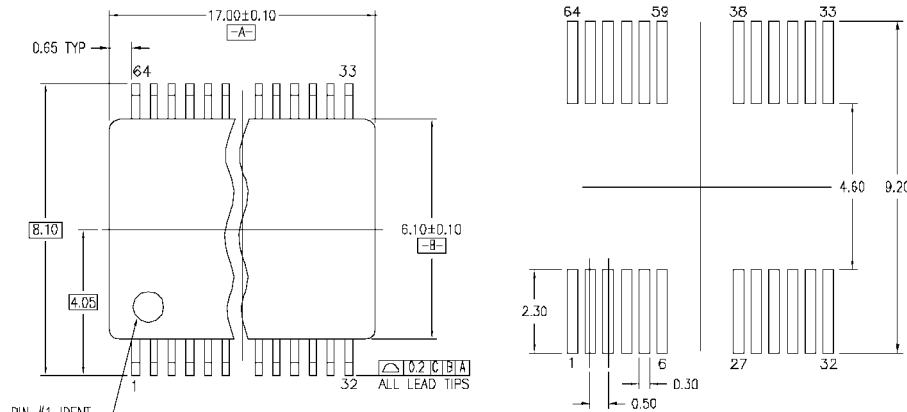

LAND PATTERN RECOMMENDATION

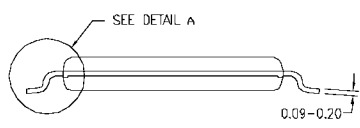
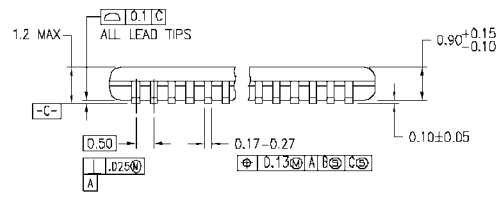

DIMENSIONS ARE IN MILLIMETERS

- NOTES:
- A. CONFORMS TO JEDEC REGISTRATION MO-153, VARIATION EF, REF NOTE B, DATE 7/93.
  - B. DIMENSIONS ARE IN MILLIMETERS.
  - C. DIMENSIONS ARE EXCLUSIVE OF BURRS, MOLD FLASH, AND THE BAR EXTRUSIONS.
  - D. DIMENSIONS AND TOLERANCES PER ANSI Y14.5M, 1982.

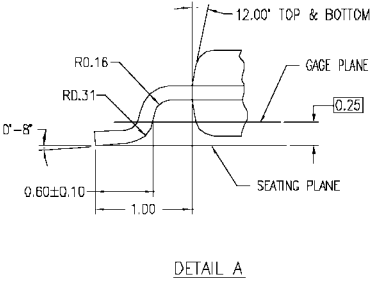

MTD64REVB

**64-Lead Thin Shrink Small Outline Package (TSSOP), JEDEC MO-153, 6.1mm Wide Package Number MTD64**

Fairchild does not assume any responsibility for use of any circuitry described, no circuit patent licenses are implied and Fairchild reserves the right at any time without notice to change said circuitry and specifications.

**LIFE SUPPORT POLICY**

FAIRCHILD'S PRODUCTS ARE NOT AUTHORIZED FOR USE AS CRITICAL COMPONENTS IN LIFE SUPPORT DEVICES OR SYSTEMS WITHOUT THE EXPRESS WRITTEN APPROVAL OF THE PRESIDENT OF FAIRCHILD SEMICONDUCTOR CORPORATION. As used herein:

1. Life support devices or systems are devices or systems which, (a) are intended for surgical implant into the body, or (b) support or sustain life, and (c) whose failure to perform when properly used in accordance with instructions for use provided in the labeling, can be reasonably expected to result in a significant injury to the user.
2. A critical component in any component of a life support device or system whose failure to perform can be reasonably expected to cause the failure of the life support device or system, or to affect its safety or effectiveness.

[www.fairchildsemi.com](http://www.fairchildsemi.com)