



MATERIALS AND FINISHES

SEE SD-73412-050

P/N: 73118-0250: THIS IS P/N: 73412-0502 PLACED IN A SINGLE BAG WITH LABEL

CHG: TITLE CHG TO
MCRF25 FROM UJFL
EC NO: URF2016-0030 2015/07/27
DRWN: YCHENG
CHKD:
APPR: YCHENG 2015/07/28
A1

QUALITY SYMBOLS
 = 0
 = 0
 DESCRIPTION
 REV

GENERAL TOLERANCES (UNLESS SPECIFIED)

	mm	INCH
4 PLACES	± .---	± .---
3 PLACES	± .---	± .---
2 PLACES	± .---	± .---
1 PLACE	± .---	± .---
ANGULAR ± .---°		

DRAFT WHERE APPLICABLE
MUST REMAIN
WITHIN DIMENSIONS

DIMENSION STYLE
MM/IN

DRAWN BY	DATE
AROBERTSON	2011/05/04
CHECKED BY	DATE
SSS	2011/05/04
APPROVED BY	DATE
JWIENER	2011/05/05

MATERIAL NO. SEE TABLE
 SIZE C THIS DRAWING CONTAINS INFORMATION THAT IS PROPRIETARY TO MOLEX INCORPORATED AND SHOULD NOT BE USED WITHOUT WRITTEN PERMISSION

SCALE DESIGN UNITS METRIC
 THIRD ANGLE PROJECTION

TITLE CA MCRF25 TO MCRF25 WITH 50 OHM ON 1.32 CABLE CA-MCRF25/MCRF25

 MOLEX INCORPORATED

DOCUMENT NO. SD-73118-025 SHEET NO. 1 OF 1

MATERIALS AND FINISHES

MATED HEIGHT : 2.5MM (.098)

BODY: PHOSPHOR BRONZE
PLATED GOLD

CENTER CONTACT: PHOSPHOR BRONZE
PLATED GOLD

HOUSING: PBT

CABLE: 1.32 CABLE

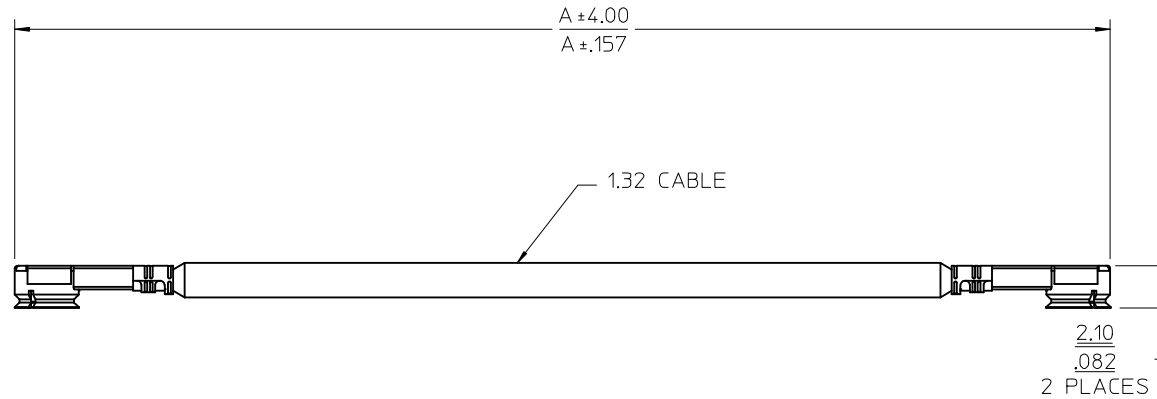
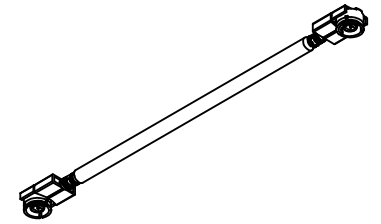

5	73412-0508	50.00	1.969
4	73412-0506	90.00	3.543
3	73412-0504	162.00	6.378
2	73412-0502	110.00	4.330
1	73412-0500	42.00	1.650
	PART NO.	DIMENSION A	

PART NO. 73118-0250 IS 73412-0502
PACKAGED ONE PIECE PER BAG

CHG: 1) TITLE CHG TO MCRF25 2) DIM. UPDATE 2.10 WAS 2.00 3) REMOVE "U.F.L." EC NO: URF2016-0030 DRAWN: YCHENG 2015/07/16 CHKD: APPR: YCHENG 2015/07/28 C4	QUALITY SYMBOLS ▽=0 ▽=0	GENERAL TOLERANCES (UNLESS SPECIFIED) <table border="1"> <tr> <td></td> <td>mm</td> <td>INCH</td> </tr> <tr> <td>4 PLACES</td> <td>± .005</td> <td>± .0002</td> </tr> <tr> <td>3 PLACES</td> <td>± .005</td> <td>± .0002</td> </tr> <tr> <td>2 PLACES</td> <td>± .005</td> <td>± .0002</td> </tr> <tr> <td>1 PLACE</td> <td>± .005</td> <td>± .0002</td> </tr> </table> ANGULAR ± 2 °		mm	INCH	4 PLACES	± .005	± .0002	3 PLACES	± .005	± .0002	2 PLACES	± .005	± .0002	1 PLACE	± .005	± .0002	DIMENSION STYLE MM/IN DRAWN BY: YCHENG DATE: 2010/04/30 CHECKED BY: KERRIE DATE: 2010/04/30 APPROVED BY: MHUANG DATE: 2010/05/10	SCALE: METRIC DESIGN UNITS: METRIC THIRD ANGLE PROJECTION	TITLE: CA MCRF25 TO MCRF25 WITH 1.32 CABLE CA-MCRF25/MCRF25
		mm	INCH																	
	4 PLACES	± .005	± .0002																	
	3 PLACES	± .005	± .0002																	
2 PLACES	± .005	± .0002																		
1 PLACE	± .005	± .0002																		
DRAFT WHERE APPLICABLE MUST REMAIN WITHIN DIMENSIONS	MATERIAL NO. SEE TABLE SIZE: C	MOLEX INCORPORATED MOLEX	DOCUMENT NO. SD-73412-050 SHEET NO. 1 OF 2																	
THIS DRAWING CONTAINS INFORMATION THAT IS PROPRIETARY TO MOLEX INCORPORATED AND SHOULD NOT BE USED WITHOUT WRITTEN PERMISSION																				

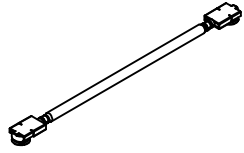

PART NO. 73412-050X

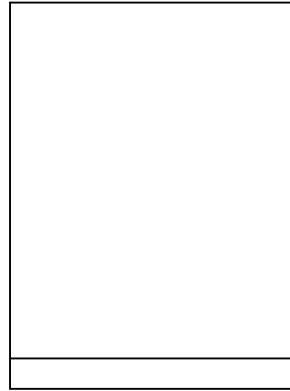
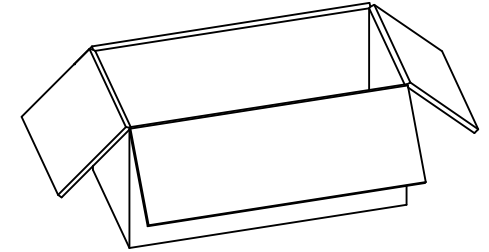
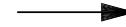
1000 PCS PER BAG
BAG P/N: 89707-017610000 PCS PER CARTON BOX
CARTON BOX P/N: 96707-0002

SEE SHEET 1 EC NO: URF2016-0030 DRAWN: YCHENG 2015/07/16 CHKD: APPR: YCHENG 2015/07/28	DESCRIPTION REV	QUALITY SYMBOLS	GENERAL TOLERANCES (UNLESS SPECIFIED)		DIMENSION STYLE MM/IN		SCALE 1:5	DESIGN UNITS METRIC	THIRD ANGLE PROJECTION	
		▽=0	mm	INCH	DRAWN BY YCHENG	DATE 2010/04/30	TITLE CA MCRF25 TO MCRF25 WITH 1.32 CABLE CA-MCRF25/MCRF25 molex	DOCUMENT NO. SD-73412-050	SHEET NO. 2 OF 2	
		▽=0	4 PLACES ±	±	CHECKED BY KERRIE	DATE 2010/04/30				
		▽=0	3 PLACES ±	±	APPROVED BY MHUANG	DATE 2010/05/10				
▽=0	2 PLACES ±	±	MATERIAL NO. SEE SHEET 1							
			0 PLACE ±	±	ANGULAR ± 2°		THIS DRAWING CONTAINS INFORMATION THAT IS PROPRIETARY TO MOLEX INCORPORATED AND SHOULD NOT BE USED WITHOUT WRITTEN PERMISSION			
DRAFT WHERE APPLICABLE MUST REMAIN WITHIN DIMENSIONS										