

"18350" LITHIUM-ION BATTERY HOLDERS

THM Leaf Springs

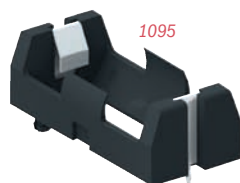

1097 (Dual Cell)
Not Shown

THM Polarized

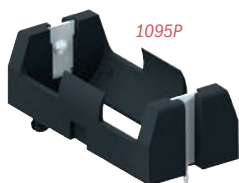

1097P (Dual Cell)
Not Shown

Solder Lugs*

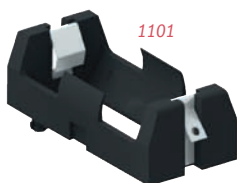

1102 (Dual Cell)
Not Shown

SMT Leaf Springs

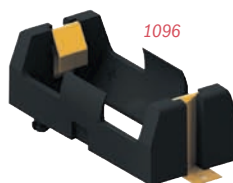

1098 (Dual Cell)
Not Shown

SMT Polarized

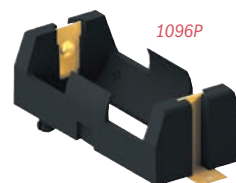

1098P (Dual Cell)
Not Shown

FEATURES

- Low profile surface mount holder for Cylindrical Lithium and alkaline batteries
- UL 94V-0 heat resistant nylon housing well suited for reflow soldering
- Battery installation and removal does not require tools
- Securely holds battery in place

- Accomodates cells with or without built-in PCB protection circuits
- Polarity clearly marked for orientation
- Polarized holders available for protection against improper battery installation

Operating Temp Range:

-60°F to +290°F (-50°C to +145°C)

APPLICATIONS

- Computer memory, power backup systems
- Digital readers
- Laptop and touch pad computers
- PLC and industrial controls
- Electronic cigarette/vapor industry



PC Battery Clip Available
See Page 11.

THRU HOLE MOUNT

SURFACE MOUNT

SINGLE CELL

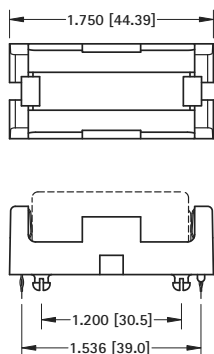
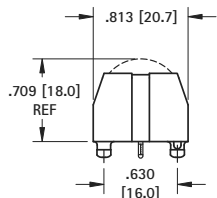

Mounting Detail

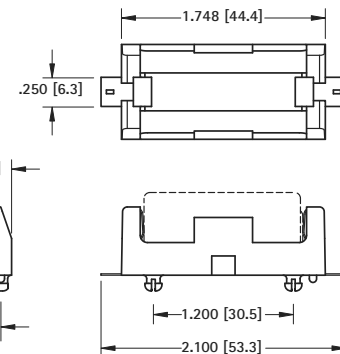
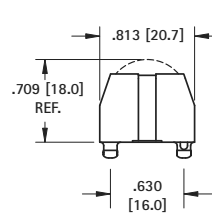
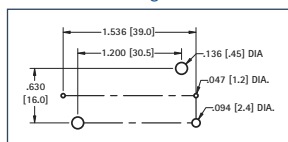

Pad Layout

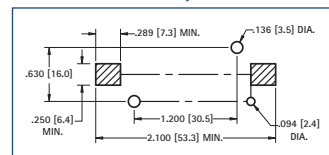

SPECIFICATIONS

Base: High Temp Nylon 46, UL 94V-0
Contacts: .012 (.30) Stainless Steel, Tin-Nickel Plate

CAT. NO. 1095 Leaf Springs

CAT. NO. 1095P Polarized Holder

CAT. NO. 1101 Solder Lugs *see image above

Packaging Spec's: 50 pieces per tray

SPECIFICATIONS

Base: High Temp Nylon 46, UL 94V-0
Contacts: .012 (.30) Stainless Steel, Gold Plate (Flash)

CAT. NO. 1096 Leaf Springs

CAT. NO. 1096P Polarized Holder

Packaging Spec's: 50 pieces per tray

DUAL CELL

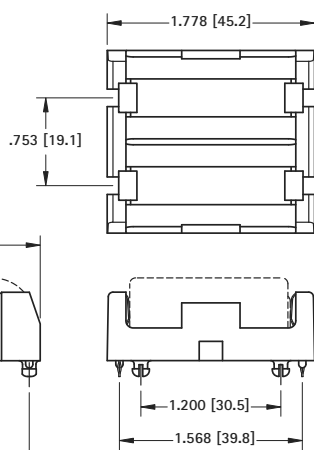
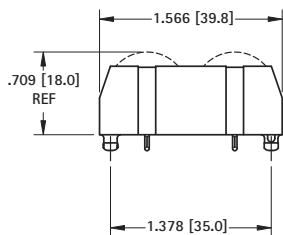
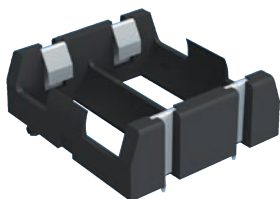

Mounting Detail

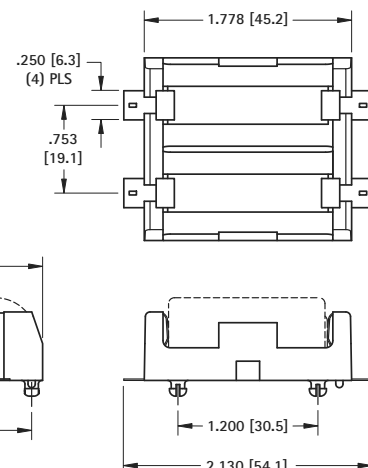
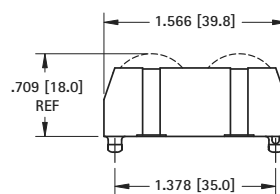
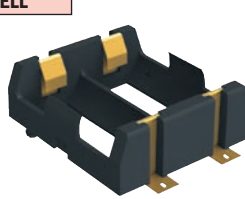
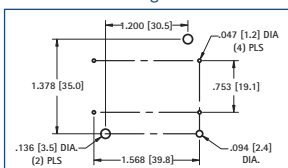

Pad Layout

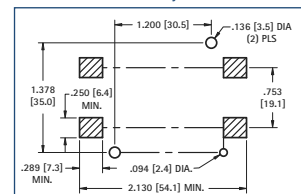

SPECIFICATIONS

Base: High Temp Nylon 46, UL 94V-0
Contacts: .012 (.30) Stainless Steel, Tin-Nickel Plate

CAT. NO. 1097 Leaf Springs

CAT. NO. 1097P Polarized Holder

CAT. NO. 1102 Solder Lugs *see image above

Packaging Spec's: 25 pieces per tray

SPECIFICATIONS

Base: High Temp Nylon 46, UL 94V-0
Contacts: .012 (.30) Stainless Steel, Gold Plate (Flash)

CAT. NO. 1098 Leaf Springs

CAT. NO. 1098P Polarized Holder

Packaging Spec's: 25 pieces per tray

"18350" LITHIUM-ION BATTERY HOLDERS