

# **QT-Brightek Side View LED Series**

## **0602 Side View LED**

**Part No.: QBLP617 Series**

---

**Table of Contents:**

Introduction .....	3
Electrical / Optical Characteristic (T=25 °C) .....	4
Absolute Maximum Rating .....	4
CIE Chromaticity Table .....	7
Characteristic Curves.....	8
Solder Profile & Footprint.....	10
Packing .....	11
Labeling .....	12
Ordering Information .....	12
Revision History .....	13
Disclaimer .....	13

## Introduction

**Feature:**

- Water clear lens
- Package in tape and reel
- Side View Ultra bright 0602 LED package
- InGaN technology for IG/IB/IW
- AlInGaP technology for R/AG/Y/O
- 140° Viewing Angle

**Description:**

These ultra bright side view 0602 LEDs have a height profile of 0.6mm. With higher packing density and smaller footprint, these LEDs are ideal for smaller equipment and miniature application.

**Application:**

- Status indication
- Back lighting application
- General Use

**Certification & Compliance:**

- TS16949
- ISO9001
- RoHS Compliant



**Dimension:**

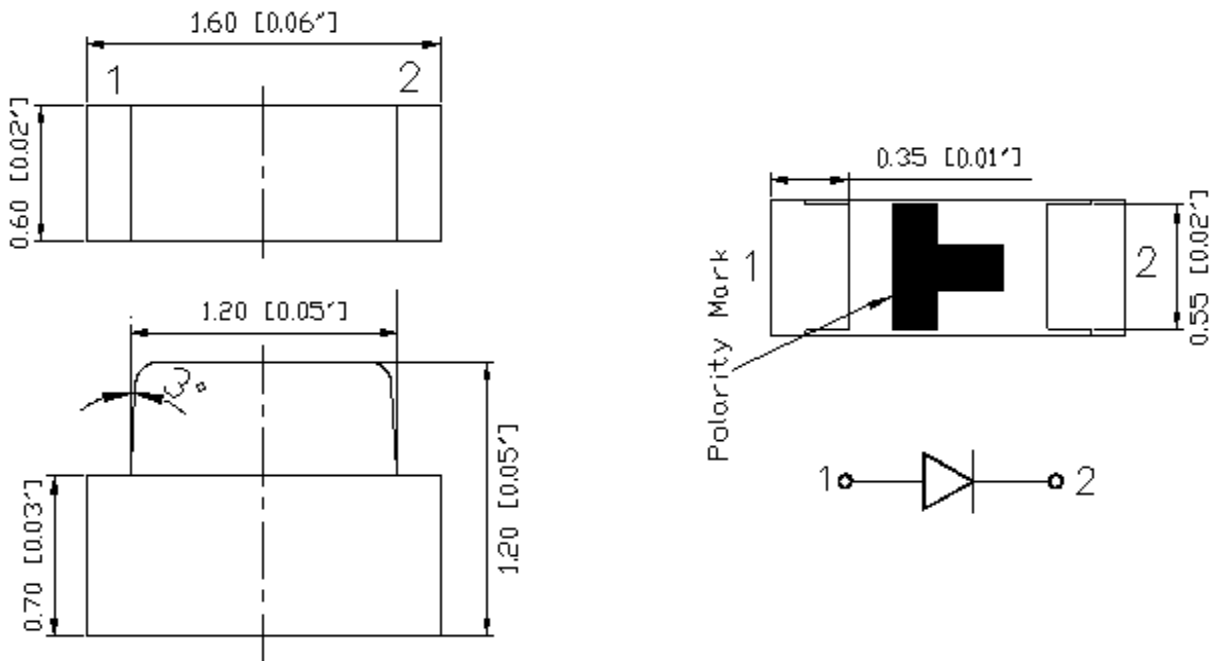

Units: mm / tolerance = +/-0.1mm

### Electrical / Optical Characteristic (T=25 °C)

Product	Color	I <sub>F</sub> (mA)	V <sub>F</sub> (V)		λ <sub>D</sub> (nm)			I <sub>V</sub> (mcd)	
			Typ.	Max.	Min.	Typ.	Max.	Min.	Typ.
QBLP617-IB	Blue	20	3.1	3.7	465	470	475	50	63
QBLP617-IG	True Green	20	3.1	3.7	520	525	530	200	380
QBLP617-R	Red	20	2.0	2.5	615	620	630	63	100
QBLP617-AG	Yellow Green	20	2.0	2.5	565	570	576	25	35
QBLP617-Y	Yellow	20	2.0	2.5	585	590	595	80	150
QBLP617-O	Orange	20	2.0	2.5	600	605	610	80	165
QBLP617-IW	White	20	3.1	3.7	-	X = 0.28 Y = 0.29	-	160	250

### Absolute Maximum Rating

Material	P <sub>d</sub> (mW)	I <sub>F</sub> (mA)	I <sub>FP</sub> (mA)*	V <sub>R</sub> (V)	T <sub>OP</sub> (°C)	T <sub>ST</sub> (°C)	T <sub>SOL</sub> (°C)**
InGaN	111	30	125	5	-40 to +80	-40 to +85	260
AllnGaP	75	30	125	5	-40 to +80	-40 to +85	260

\*Duty 1/8 @ 1kHz

\*\*IR Reflow for no more than 10 sec @ 260 °C

**Forward Voltage  $V_F$  for AlInGaP @  $I_F=20mA$** 

Bin	Min.	Max.	Unit
□	1.7	2.5	V

**Forward Voltage  $V_F$  for InGaN @  $I_F=20mA$** 

Bin	Min.	Max.	Unit
f	2.8	3.1	V
g	3.1	3.4	
h	3.4	3.7	

**Luminous Intensity  $I_V$  @  $I_F=20mA$** 

Bin	Min.	Max.	Unit
D	25	32	mcd
E	32	40	
F	40	50	
G	50	63	
H	63	80	
I	80	100	
J	100	125	
K	125	160	
L	160	200	
M	200	250	
N	250	320	
O	320	400	
P	400	500	
Q	500	630	

**Dominant Wavelength  $\lambda_D$  for Blue @  $I_F=20mA$** 

Bin	Min.	Max.	Unit
G	465	467.5	nm
H	467.5	470	
I	470	472.5	
J	472.5	475	

**Dominant Wavelength  $\lambda_D$  for Green @  $I_F=20\text{mA}$** 

Bin	Min.	Max.	Unit
U	520	522.5	nm
V	522.5	525	
W	525	527.5	
X	527.5	530	

**Dominant Wavelength  $\lambda_D$  for Red @  $I_F=20\text{mA}$** 

Bin	Min.	Max.	Unit
s	615	620	nm
t	620	625	
u	625	630	

**Dominant Wavelength  $\lambda_D$  for Yellow Green @  $I_F=20\text{mA}$** 

Bin	Min.	Max.	Unit
h	565	568	nm
i	568	572	
j	572	576	

**Dominant Wavelength  $\lambda_D$  for Yellow @  $I_F=20\text{mA}$** 

Bin	Min.	Max.	Unit
m	585	590	nm
n	590	595	

**Dominant Wavelength  $\lambda_D$  for Orange @  $I_F=20\text{mA}$** 

Bin	Min.	Max.	Unit
p	600	605	nm
q	605	610	

**CIE Chromaticity Table**

**CCT**

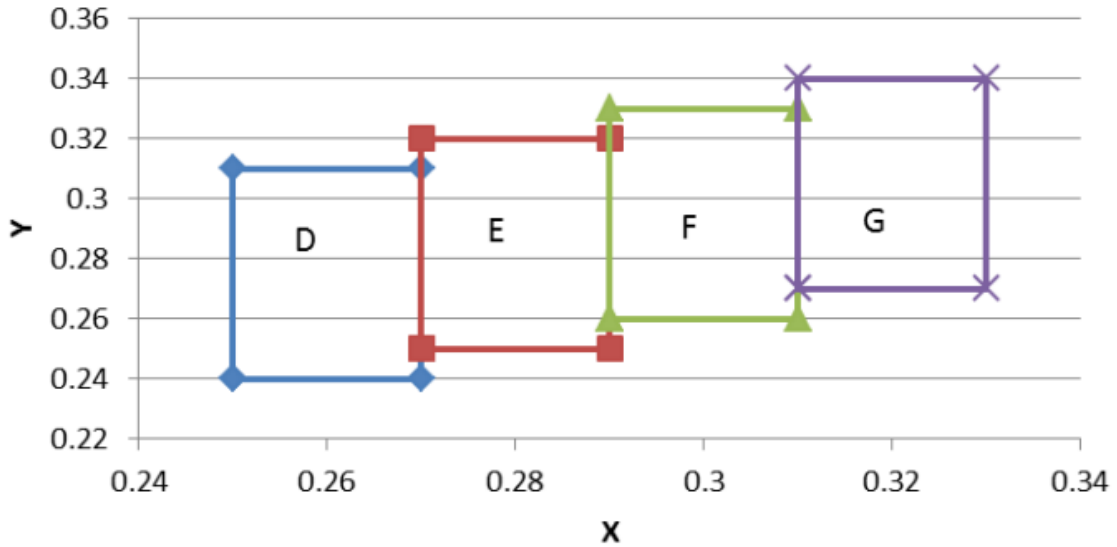

D		E		F		G	
0.25	0.24	0.27	0.25	0.29	0.26	0.31	0.27
0.25	0.31	0.27	0.32	0.29	0.33	0.31	0.34
0.27	0.31	0.29	0.32	0.31	0.33	0.33	0.34
0.27	0.24	0.29	0.25	0.31	0.26	0.33	0.27
0.25	0.24	0.27	0.25	0.29	0.26	0.31	0.27

## Characteristic Curves

InGaN (IB/IG/IW)

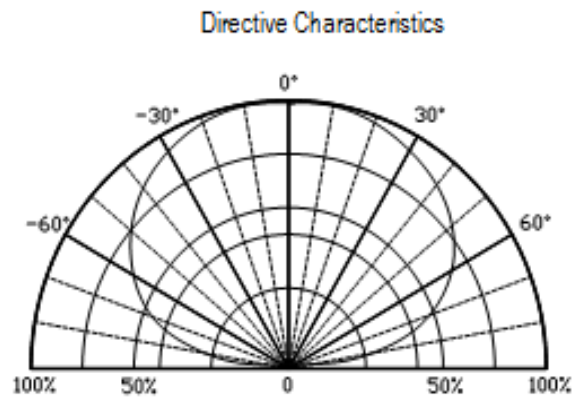
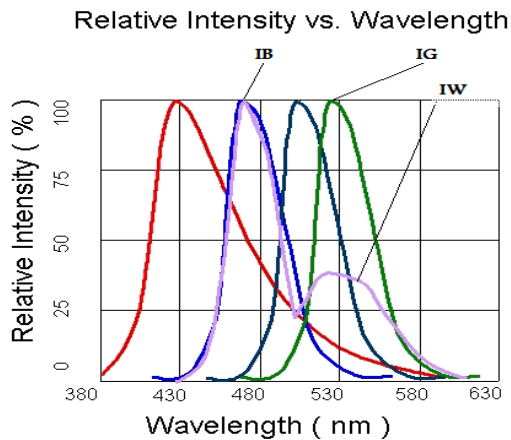
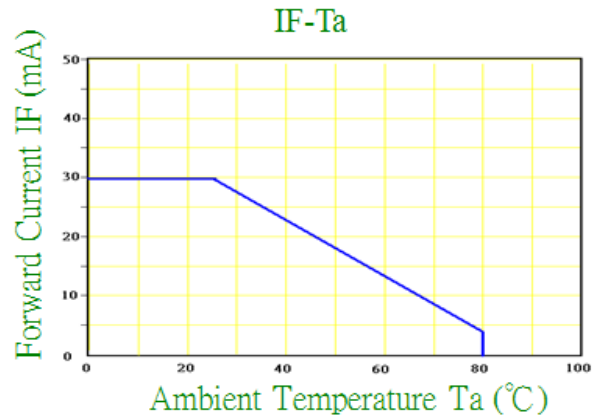
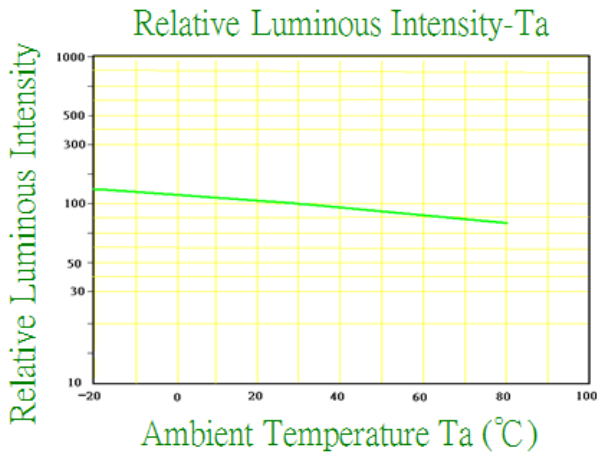
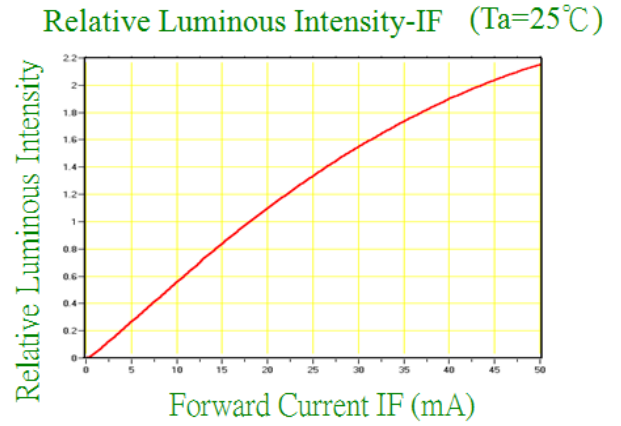
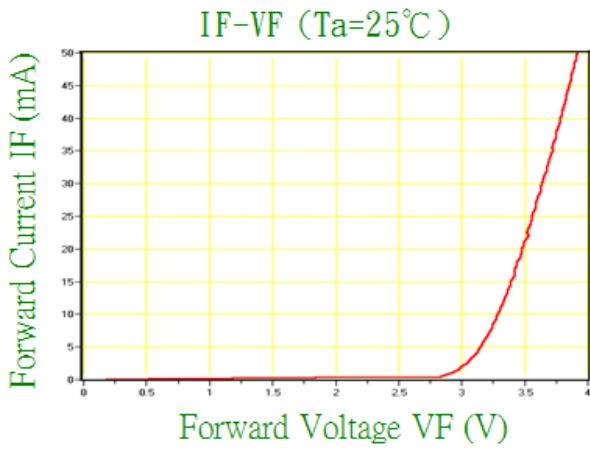



AllnGaP (R/AG/Y/O)

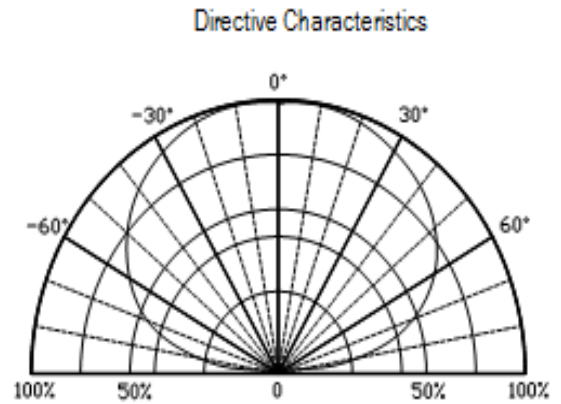
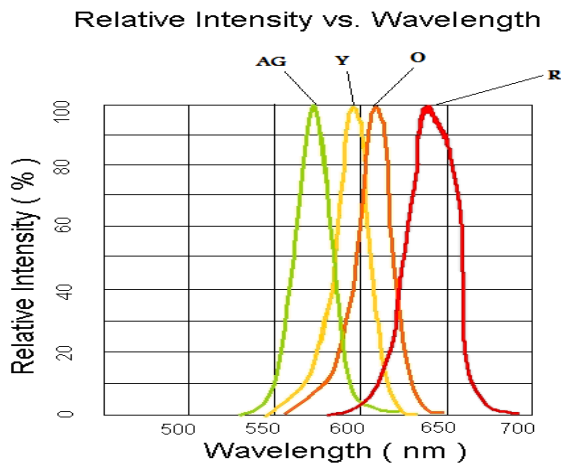
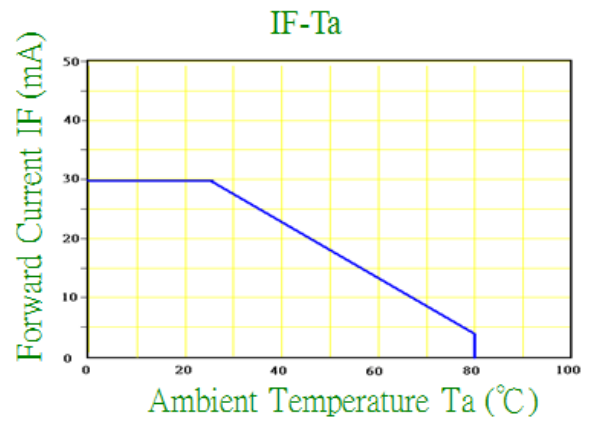
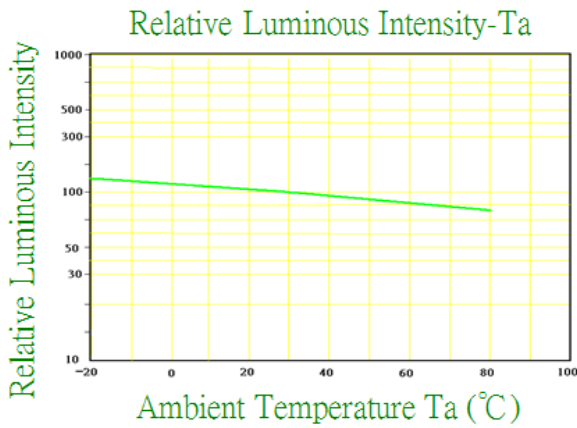
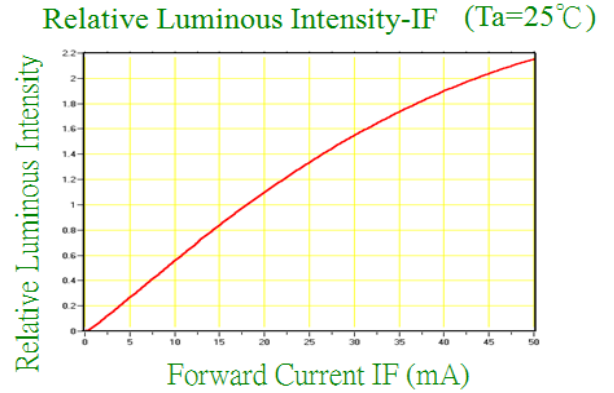
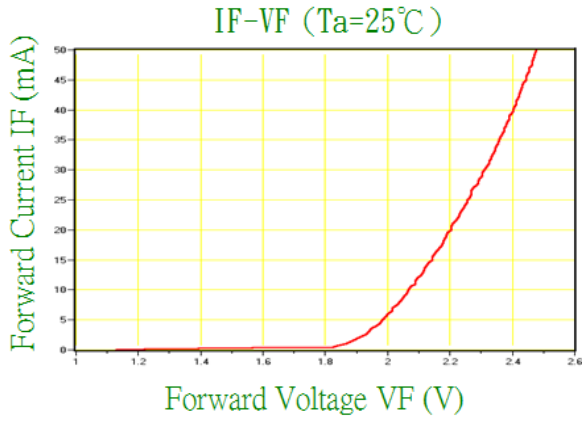

## Solder Profile & Footprint

- Recommended tin solder specifications: melting temperature in the range of 178~192 °C
- The recommended reflow soldering profile is as follows (temperatures indicated are as measured on the surface of the LED resin):

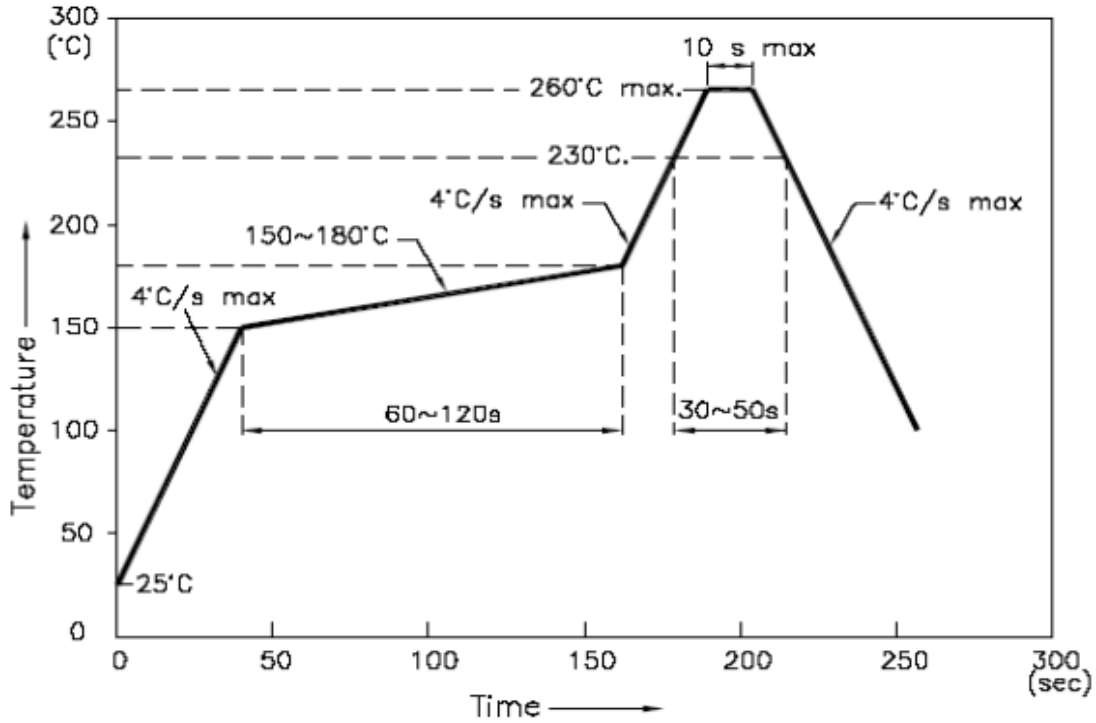

### Recommended Pad Layout

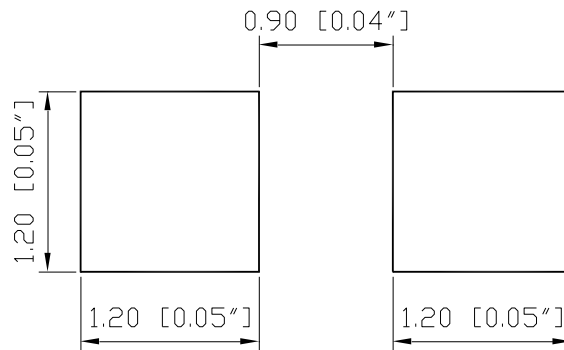

Units: mm

Tolerance: ± 0.1mm

## Packing

### Reel Dimension:

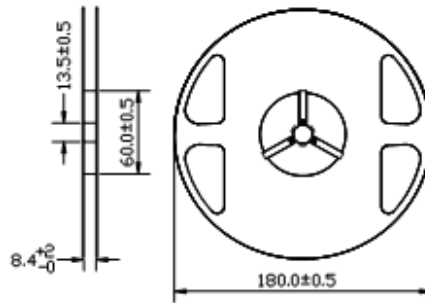

Unit: mm

### Tape Dimension:

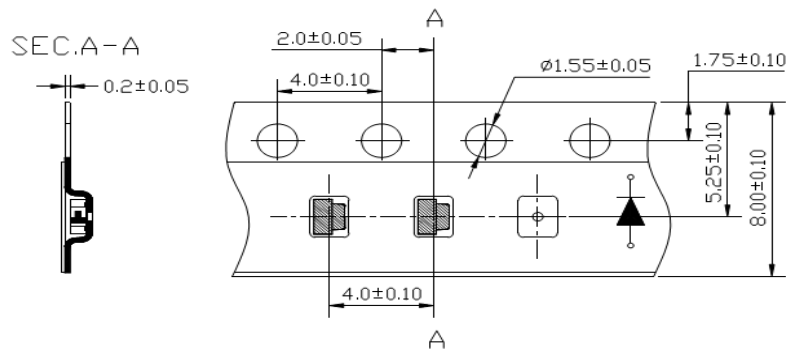

Unit: mm

### Arrangement of Tape:

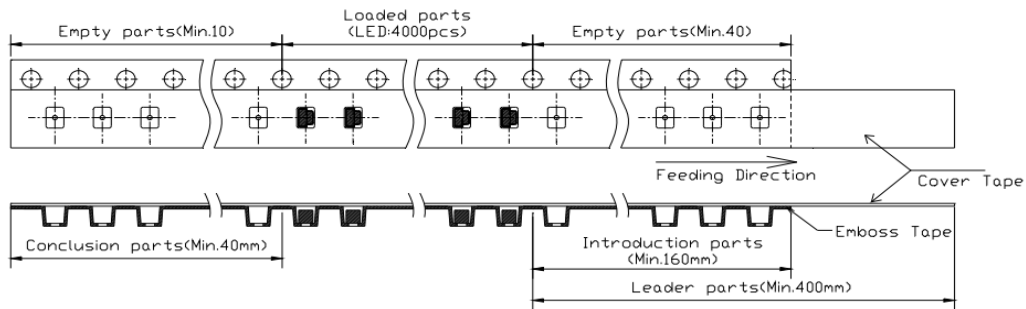

### Packaging Specifications:

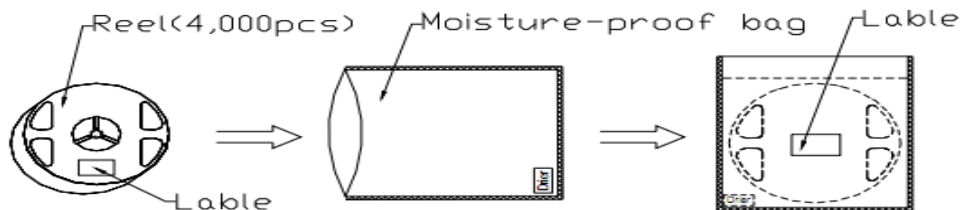

**Labeling**

**Part No:** \_\_\_\_\_  
**Customer P/N:** \_\_\_\_\_  
**Item:** \_\_\_\_\_  
**Q'ty:** \_\_\_\_\_  
**Vf:** \_\_\_\_\_  
**Iv:** \_\_\_\_\_  
**WI:** \_\_\_\_\_  
**Date:** \_\_\_\_\_

**Made in China****Ordering Information**

Part #	Orderable Part #	Spec Range	Quantity per reel
QBLP617-IB	QBLP617-IB	Iv=63mcd typ. @ 20mA / Color=465nm ~ 475nm	4,000 units
QBLP617-IG	QBLP617-IG	Iv=380mcd typ. @ 20mA / Color=520nm ~ 530nm	4,000 units
QBLP617-R	QBLP617-R	Iv=100mcd typ. @ 20mA / Color=615nm ~ 630nm	4,000 units
QBLP617-AG	QBLP617-AG	Iv=35mcd typ. @ 20mA / Color=565nm ~ 576nm	4,000 units
QBLP617-Y	QBLP617-Y	Iv=150 mcd typ. @ 20mA / Color=585nm ~ 595nm	4,000 units
QBLP617-O	QBLP617-O	Iv=165mcd typ. @ 20mA / Color=600nm ~ 610nm	4,000 units
QBLP617-IW	QBLP617-IW	Iv=250mcd typ. @ 20mA / CCT Coordinate: (X= 0.28, Y = 0.29) typ.	4,000 units

## Revision History

Description:	Revision #	Revision Date
New Release of QBLP617_series	V1.0	01/11/2012
Add Blue color Spec	V1.1	01/12/2012
Add Orange and White, update to new format	V1.2	06/18/2012
Update White luminous intensity	V1.3	09/13/2013
Update Blue wavelength and luminous intensity	V1.4	02/06/2014

## Disclaimer

QT-BRIGHTTEK reserves the right to make changes without further notice to any products herein to improve reliability, function or design. QT-BRIGHTTEK does not assume any liability arising out of the application or use of any product or circuit described herein; neither does it convey any license under its patent rights, nor the rights of others.

## Life Support Policy

QT-BRIGHTTEK's products are not authorized for use as critical components in life support devices or systems without the express written approval of QT-BRIGHTTEK. As used herein:

1. Life support devices or systems are devices or systems which, (a) are intended for surgical implant into the body, or (b) support or sustain life, and (c) whose failure to perform when properly used in accordance with instructions for use provided in the labeling, can be reasonably expected to result in a significant injury of the user.
2. A critical component in any component of a life support device or system whose failure to perform can be reasonably expected to cause the failure of the life support device or system, or to affect its safety or effectiveness.