Title	<i>Reference Design Report for a 1.44 W Non-Isolated Buck Converter Using LinkSwitch™-TN2 LNK3204D/P/G</i>
Specification	Input: 85 VAC – 265 VAC; Output: 12 V, 120 mA
Application	Small Appliance
Author	Applications Engineering Department
Document Number	RDR-506
Date	November 8, 2016
Revision	1.0

Summary and Features

- Highly integrated solution
- Lowest possible component count
- No optocoupler or Zener diode required for regulation
- Thermal overload protection with automatic recovery
- <30 mW no-load consumption
- >75% efficiency at full load
- <±3% load regulation

PATENT INFORMATION

The products and applications illustrated herein (including transformer construction and circuits external to the products) may be covered by one or more U.S. and foreign patents, or potentially by pending U.S. and foreign patent applications assigned to Power Integrations. A complete list of Power Integrations' patents may be found at www.powerint.com. Power Integrations grants its customers a license under certain patent rights as set forth at <http://www.powerint.com/ip.htm>.

Power Integrations

5245 Hellyer Avenue, San Jose, CA 95138 USA.
Tel: +1 408 414 9200 Fax: +1 408 414 9201
www.power.com

Table of Contents

1	Introduction	3
2	Power Supply Specification	4
3	Schematic	5
4	Circuit Description	6
4.1	Input EMI Filtering.....	6
4.2	LinkSwitch-TN2 IC Primary.....	6
4.3	Output Rectification	7
4.4	Output Feedback	7
5	PCB Layout	8
6	Bill of Materials	9
7	Transformer Design Spreadsheet	10
8	Performance Data	11
8.1	Efficiency vs. Line	11
8.2	Efficiency vs. Load	12
8.3	No-Load Input Power	13
8.4	Load Regulation	14
8.5	Line Regulation at Full Load	15
9	Open Case Thermal Performance	16
10	Waveforms	17
10.1	Switching Waveforms.....	17
10.1.1	LNK3204D Waveforms.....	17
10.1.2	LNK3204D Drain Voltage and Current Waveforms During Start-up	17
10.1.3	Drain Current and Output Waveform During Output Short	18
10.1.4	Freewheeling Diode Waveforms	18
10.1.5	Output Voltage and Current Waveforms During Start-Up	19
10.2	Output Ripple Measurements.....	20
11.2.1	Ripple Measurement Technique	20
10.2.2	Measurement Results	21
10.2.3	Ripple Voltage Waveforms	22
11	Conductive EMI.....	23
11.1	120 mA Resistive Load, Floating Output (QPK / AV)	23
11.1.1	Line	23
11.1.2	Neutral.....	25
12	Lighting Surge	27
12.1	Differential Mode Test.....	27
13	Revision History	28

Important Note:

Although this board is designed to satisfy safety isolation requirements, the engineering prototype has not been agency approved. Therefore, all testing should be performed using an isolation transformer to provide the AC input to the prototype board.



1 Introduction

This document is an engineering prototype report describing a non-isolated 12 V, 120 mA power supply utilizing a LNK3204D/P/G from Power Integrations.

The document contains the power supply specification, schematic, bill-of-materials, printed circuit layout, and performance data.

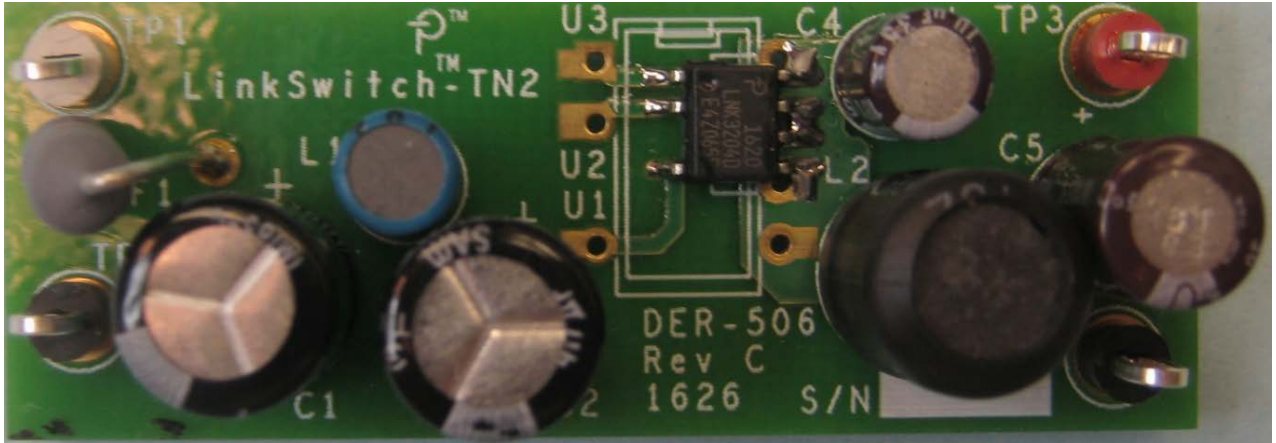

Figure 1– Populated Circuit Board Photograph, Top.

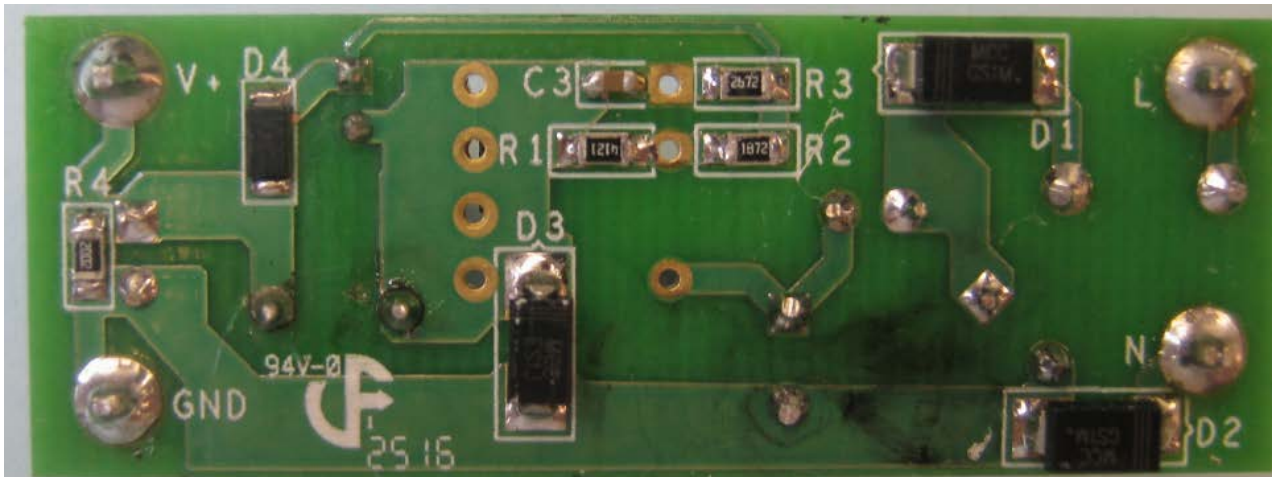

Figure 2 – Populated Circuit Board Photograph, Bottom.

2 Power Supply Specification

The table below represents the minimum acceptable performance of the design. Actual performance is listed in the results section.

Description	Symbol	Min	Typ	Max	Units	Comment	
Input							
Voltage	V_{IN}	85		265	VAC	2 Wire – no P.E.	
Frequency	f_{LINE}	47	50/60	64	Hz		
No-load Input Power (230 VAC)				<30	mW		
Output							
Output Voltage	V_{OUT}		12		V	± 5%. 20 MHz Bandwidth.	
Output Ripple Voltage	V_{RIPPLE}			150	mV		
Output Current	I_{OUT}		0.12		A		
Total Output Power							
Continuous Output Power	P_{OUT}		1.44		W		
Peak Output Power	P_{OUT_PEAK}				W		
Efficiency							
Full Load	η	75			%	Measured at P_{OUT} 25 °C.	
Environmental							
Conducted EMI		Meets CISPR22B / EN55022B					
Line Surge Differential Mode (L1-L2)			1		kV	1.2/50 μ s surge, IEC 1000-4-5, Series Impedance: Differential Mode: 2 Ω .	
Ambient Temperature	T_{AMB}	0		40	°C	Free Convection, Sea Level.	

3 Schematic

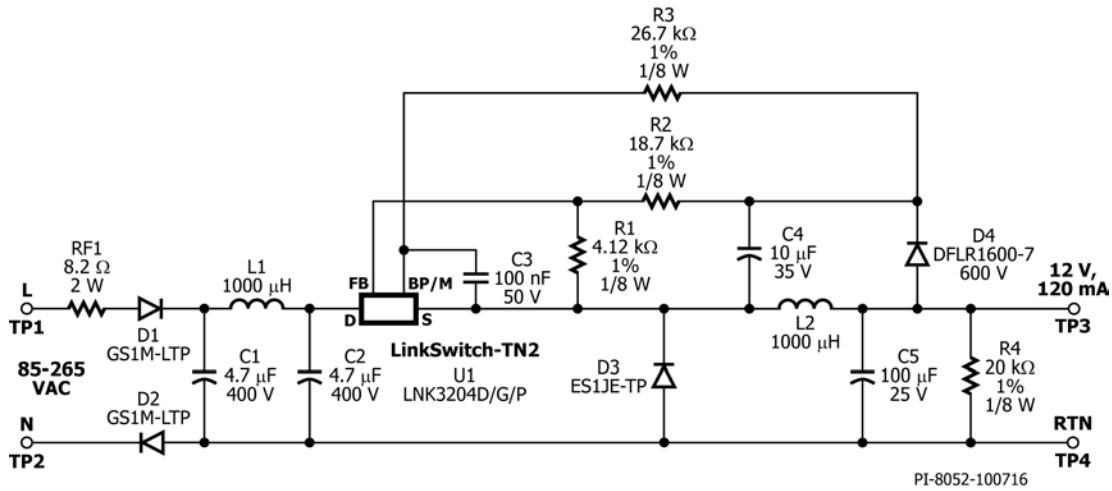

Figure 3 – Schematic.

*Note: U1 can be implemented as LNK3204D, LNK3204G or LNK3204P.



4 Circuit Description

The schematic in Figure 3 shows a buck converter using LNK3204D/P/G. The circuit provides a non-isolated 12 V, 120 mA continuous output. In metering applications this is used to supply the control circuits and micro controller. LinkSwitch-TN2 integrates a 725 V MOSFET and control circuitry into a single low cost IC. Regulation is achieved using a low cost resistor divider feedback network. The switching frequency jitter feature of the LinkSwitch-TN2 family and the 66 kHz switching frequency of operation helps reduce EMI.

4.1 Input EMI Filtering

The input stage is comprised of fusible resistor RF1, diode D1 and D2, capacitors C1 and C2, and inductor L1. Resistor RF1 is a flameproof, fusible, wire-wound resistor. It accomplishes several functions: (a) limits inrush current to safe levels for rectifiers D1, D2 (b) provides differential mode noise attenuation and (c) acts as an input fuse in the event any other component fails short circuit. As this component is used as a fuse, it should fail safely open-circuit without emitting smoke, fire or incandescent material to meet typical safety requirements. To withstand the instantaneous inrush power dissipation, wire wound types are recommended. Metal film resistors are not recommended in place of RF1.

4.2 LinkSwitch-TN2 IC Primary

LinkSwitch-TN2 integrates a 725 V power MOSFET and control circuitry into a single low cost IC. The device is self-starting from the DRAIN (D) pin with local supply decoupling provided by a small 100 nF capacitor C3 connected to the BYPASS (BP/M) pin when AC is first applied. During normal operation the device is powered from output via a current limiting resistor R3. Here, the device LNK3204D is used in a buck converter. The supply is designed to operate in mostly discontinuous conduction mode (MDCM), with the peak L1 inductor current set by the LNK3204D internal current limit. The control scheme used is similar to the ON/OFF control used in TinySwitch™. The on-time for each switching cycle is set by the inductance value of L2, LinkSwitch-TN2 current limit and the high voltage DC input bus across C2. Output regulation is accomplished by skipping switching cycles in response to an ON/OFF feedback signal applied to the FEEDBACK (FB) pin. This differs significantly from traditional PWM schemes that control the duty factor (duty cycle) of each switching cycle. Unlike TinySwitch, the logic of the FB pin has been inverted in LinkSwitch-TN. This allows a very simple feedback scheme to be used when the device is used in the buck converter configuration. Current into the FB pin greater than 49 μ A will inhibit the switching of the internal MOSFET, while current below this allows switching cycles to occur.



4.3 *Output Rectification*

During the ON time of U1, current ramps in L2 and is simultaneously delivered to the load. During the OFF time the inductor current ramps down via free-wheeling diode D3 into C5 and is delivered to the load. Diode D3 should be selected as an ultrafast diode (t_{RR} of 35 ns or better is recommended. Capacitor C5 should be selected to have an adequate ripple current rating (low ESR type)). Please see the spreadsheet output capacitor section.

4.4 *Output Feedback*

The voltage across L2 is rectified and smoothed by D4 and C4 during the off-time of U1. To a first order, the forward voltage drops of D3 and D4 are identical and therefore, the voltage across C3 tracks the output voltage. To provide a feedback signal, the voltage developed across C3 is divided by R1 and R2 and connected to U1's FB pin. The values of R1 and R2 are selected such that at the nominal output voltage, the voltage on the FB pin is 2 V. This voltage is specified for U1 at an FB pin current of 49 μ A with a tolerance of $\pm 1.3\%$ over a temperature range of -40 to 125 °C. This allows this simple feedback to meet the required overall output tolerance of $\pm 3\%$ at rated output current.

5 PCB Layout

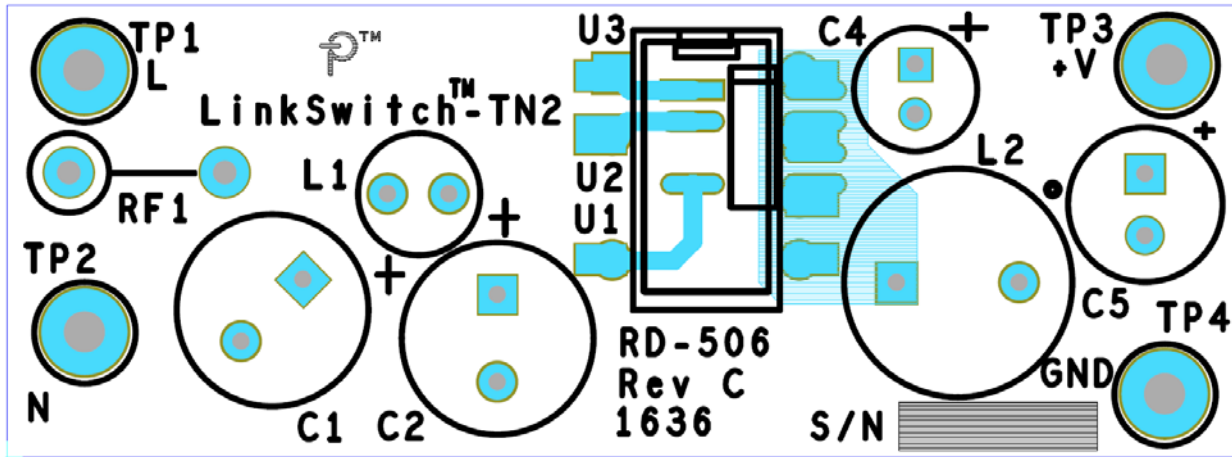

Figure 4 – Printed Circuit Layout, Top (1.97" [50 mm] L x .72" [18.4 mm] W).

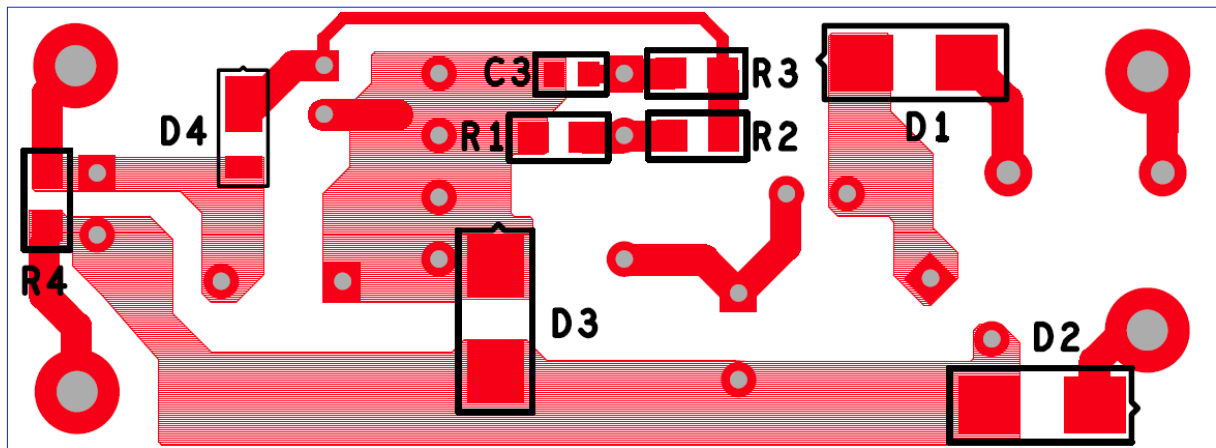

Figure 5 – Printed Circuit Layout, Bottom.

6 Bill of Materials

Item	Qty	Ref Des	Description	Mfg Part Number	Mfg
1	2	C1 C2	4.7 μ F, 400 V, Electrolytic, (8 x 11.5)	SHD400WV 4.7uF	Sam Young
2	1	C3	100 nF 50 V, Ceramic, X7R, 0603	C1608X7R1H104K	TDK
3	1	C4	10 μ F, 35 V, Electrolytic, Gen Purpose, (5 x 7)	UPW1V100MDD6	Nichicon
4	1	C5	100 μ F, 25 V, Electrolytic, Very Low ESR, 130 m Ω , (6.3 x 11)	EKZE250ELL101MF11D	Nippon Chemi-Con
5	2	D1 D2	1000 V, 1 A, DO-214AC	GS1M-LTP	Micro Commercial
6	1	D3	DIODE, GEN PURP, 600V, 1A, DO214AC	ES1JE-TP	Micro Commercial
7	1	D4	600 V, 1 A, Rectifier, Glass Passivated, POWERDI123	DFLR1600-7	Diodes, Inc.
8	1	L1	1000 μ H, 0.21 A, 5.5 x 10.5 mm	SBC1-102-211	Tokin
9	1	L2	1000 μ H, 0.510 A	RLB9012-102KL	Bourns
10	1	R1	RES, 4.12 k Ω , 1%, 1/8 W, Thick Film, 0805	ERJ-6ENF4121V	Panasonic
11	1	R2	RES, 18.7 k Ω , 1%, 1/8 W, Thick Film, 0805	ERJ-6ENF1872V	Panasonic
12	1	R3	RES, 26.7 k Ω , 1%, 1/8 W, Thick Film, 0805	ERJ-6ENF2672V	Panasonic
13	1	R4	RES, 20 k Ω , 1%, 1/8 W, Thick Film, 0805	ERJ-6ENF2002V	Panasonic
14	1	RF1	RES, 8.2 Ω , 2 W, Fusible/Flame Proof Wire Wound	CRF253-4 5T 8R2	Vitrohm
15	1	TP1	Test Point, WHT, THRU-HOLE MOUNT	5012	Keystone
16	2	TP2 TP4	Test Point, BLK, THRU-HOLE MOUNT	5011	Keystone
17	1	TP3	Test Point, RED, THRU-HOLE MOUNT	5010	Keystone
18	1	U1	LinkSwitch-TN2, LNK3204D, SO-8C	LNK3204D	Power Integrations
19	1	U2	LinkSwitch-TN2, LNK3204G, SMD-8C	LNK3204G	Power Integrations
20	1	U3	LinkSwitch-TN2, LNK3204P, DIP-8C	LNK3204P	Power Integrations

7 Transformer Design Spreadsheet

ACDC_LinkSwitch-TN_042413; Rev.2.6; Copyright Power Integrations 2007	INPUT	INFO	OUTPUT	UNIT	LinkSwitch-TN_Rev_2-6.xls: LinkSwitch-TN Design Spreadsheet
INPUT VARIABLES					
VACMIN	85			Volts	Minimum AC Input Voltage
VACMAX	265			Volts	Maximum AC Input Voltage
FL	50			Hertz	Line Frequency
VO	12.00			Volts	Output Voltage
IO	0.120			Amps	Output Current
EFFICIENCY (User Estimate)	0.75				Overall Efficiency Estimate (Adjust to match Calculated, or enter Measured Efficiency)
EFFICIENCY (Calculated Estimate)			0.76		Calculated % Efficiency Estimate
CIN	9.40		9.40	uF	Input Filter Capacitor
Input Stage Resistance			0.00	ohms	Input Stage Resistance, Fuse & Filtering
Ambient Temperature			50	deg C	Operating Ambient Temperature (deg Celsius)
Switching Topology			Buck		Type of Switching topology
Input Rectification Type	H		H		Choose H for Half Wave Rectifier and F for Full Wave Rectification
DC INPUT VARIABLES					
VMIN			86.6	Volts	Minimum DC Bus Voltage
VMAX					
LinkSwitch-TN					
LinkSwitch-TN	Auto		LNK3204		Selected LinkSwitch-TN. Ordering info - Suffix P/G indicates DIP 8 package; suffix D indicates SO8 package; second suffix N indicates lead free RoHS compliance
ILIMIT			0.257	Amps	Typical Current Limit
ILIMIT_MIN			0.240	Amps	Minimum Current Limit
ILIMIT_MAX			0.275	Amps	Maximum Current Limit
FSMIN			62000	Hertz	Minimum Switching Frequency
VDS					
PLOSS_LNK			0.33	Watts	Estimated LinkSwitch-TN losses
DIODE					
VD			0.70	Volts	Freewheeling Diode Forward Voltage Drop
VRR			600	Volts	Recommended PIV rating of Freewheeling Diode
IF					
TRR			75	ns	Recommended Reverse Recovery Time
Diode Recommendation			UF4005		Suggested Freewheeling Diode
OUTPUT INDUCTOR					
L_TYP			925.1	uH	Required value of Inductance to deliver Output Power (Includes device and inductor tolerances) Choose next higher standard available value
L			1000	uH	Output Inductor, Recommended Standard Value
L_R			2.0	Ohms	DC Resistance of Inductor
OPERATING MODE			MDCM		Mostly Discontinuous Conduction Mode (at VMIN)
KL_TOL					
K_LOSS			0.833		Loss factor. Accounts for "off-state" power loss to be supplied by inductor Calculated efficiency < K_LOSS < 1. See AN-37 for detailed explanation
ILRMS			0.13	Amps	Estimated RMS inductor current (at VMAX)
OUTPUT CAPACITOR					
DELTA_V					
MAX_ESR			500	m-Ohms	Maximum Capacitor ESR (milli-ohms)
I RIPPLE			0.24	Amps	Output Capacitor Ripple current



8 Performance Data

All measurements performed at room temperature.

8.1 Efficiency vs. Line

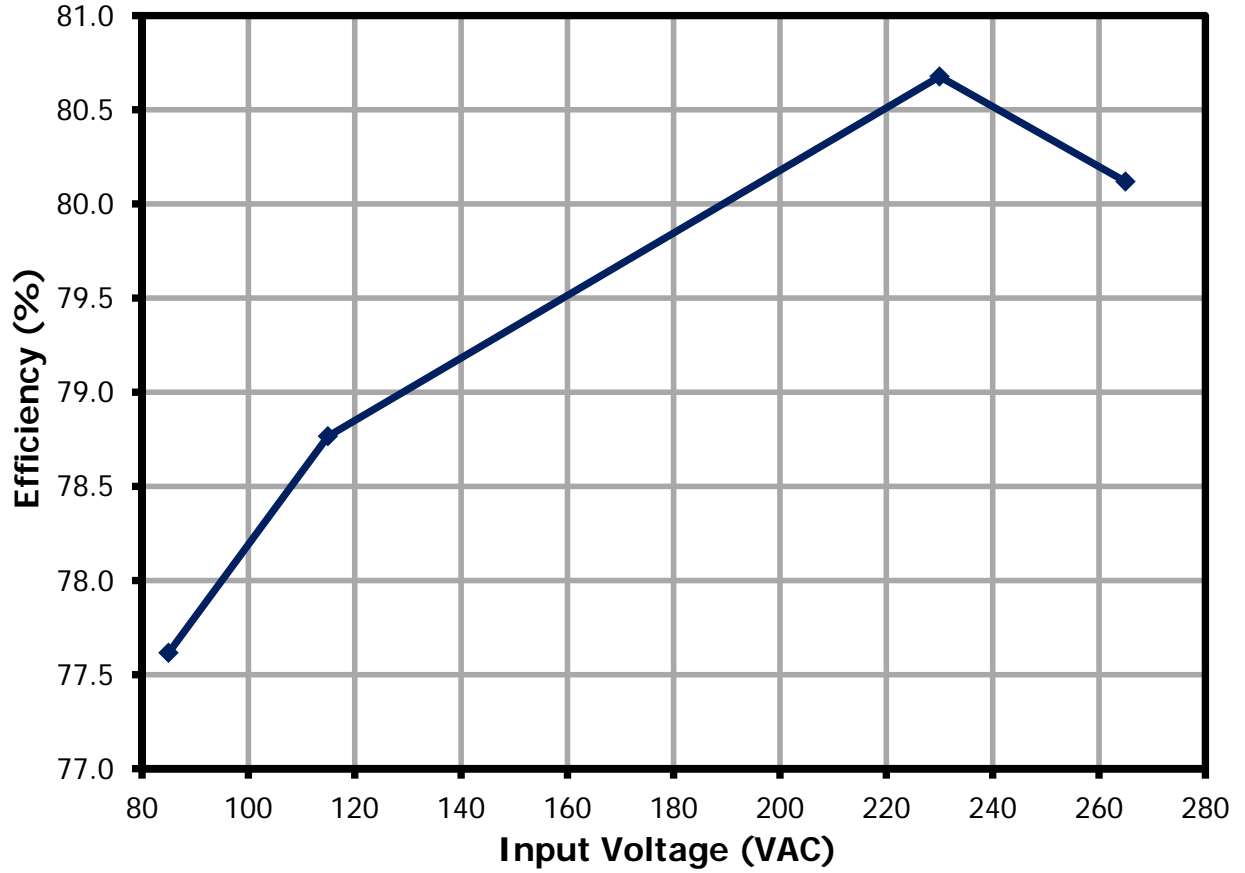

Figure 6– Efficiency vs. Line Voltage, Room temperature.



8.2 Efficiency vs. Load

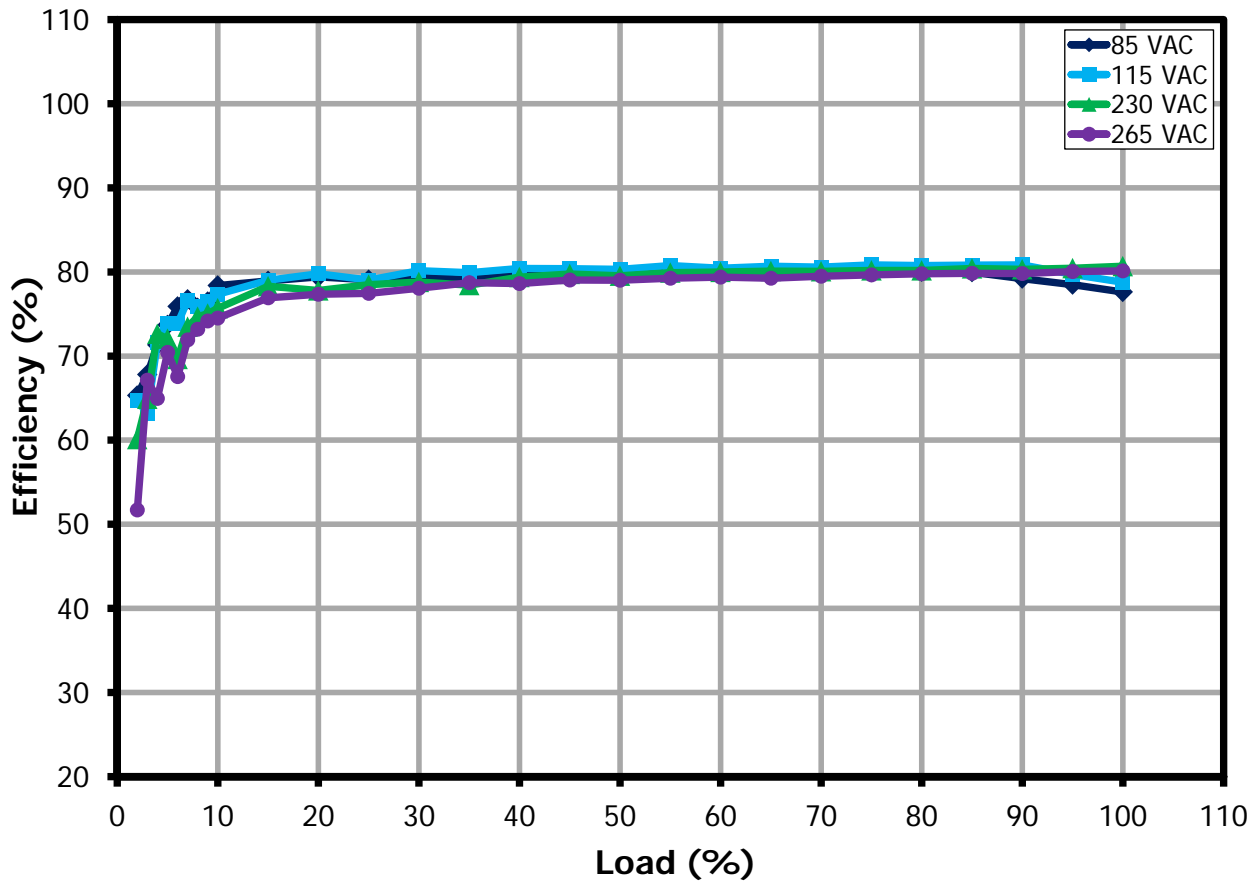

Figure 7 – Efficiency vs. Load, Room temperature.

8.3 No-Load Input Power

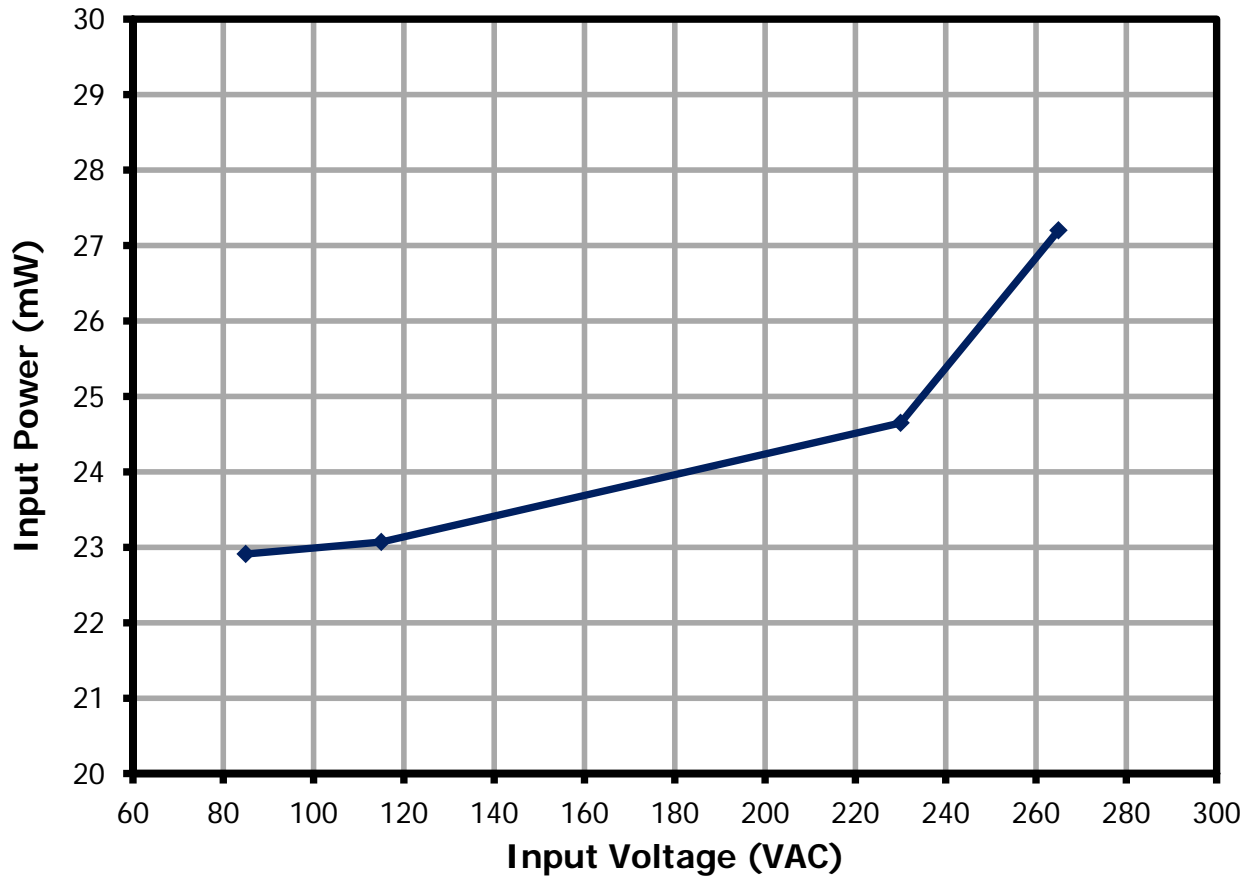

Figure 8 – No-Load Input Power vs. Input Line Voltage, Room Temperature.



8.4 Load Regulation

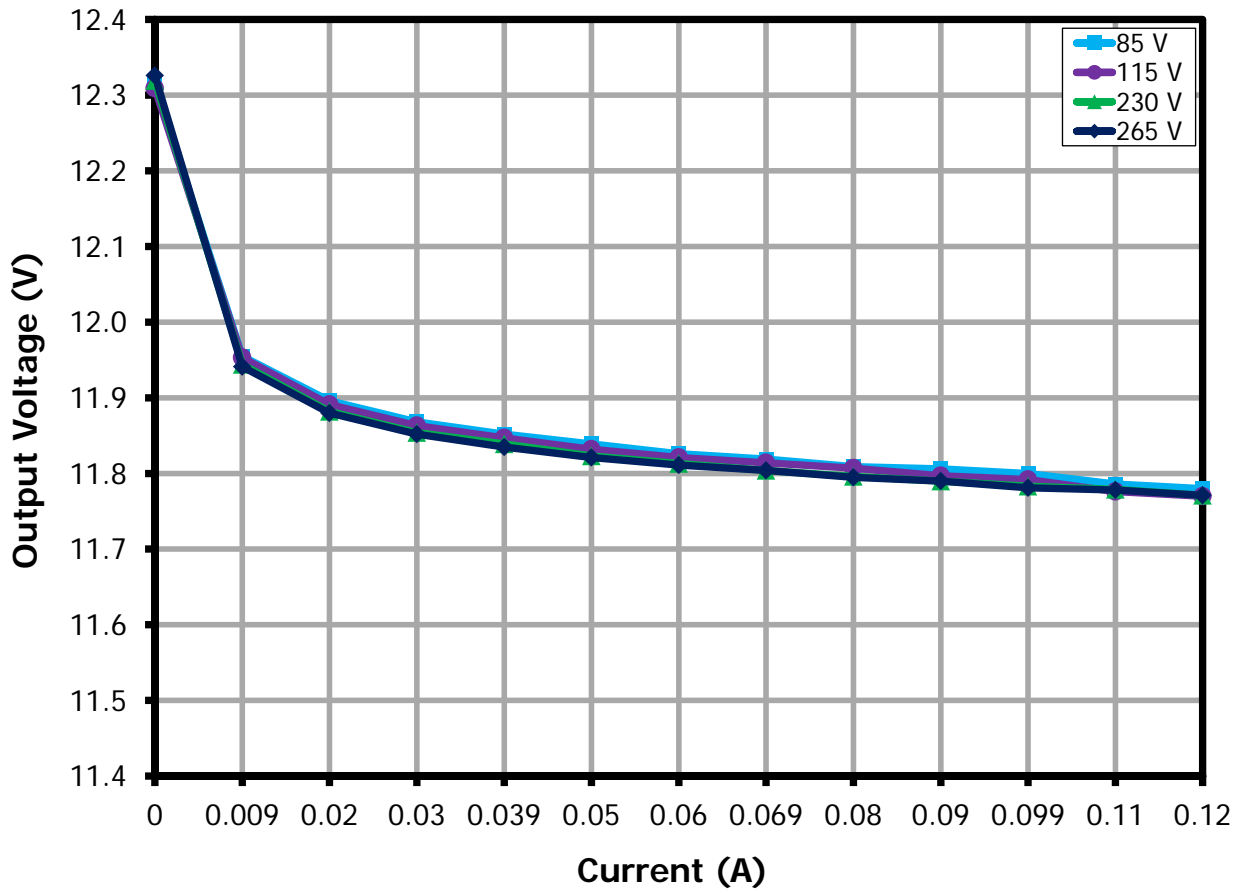

Figure 9 – Output Voltage vs. Output current, Room Temperature.

8.5 Line Regulation at Full Load

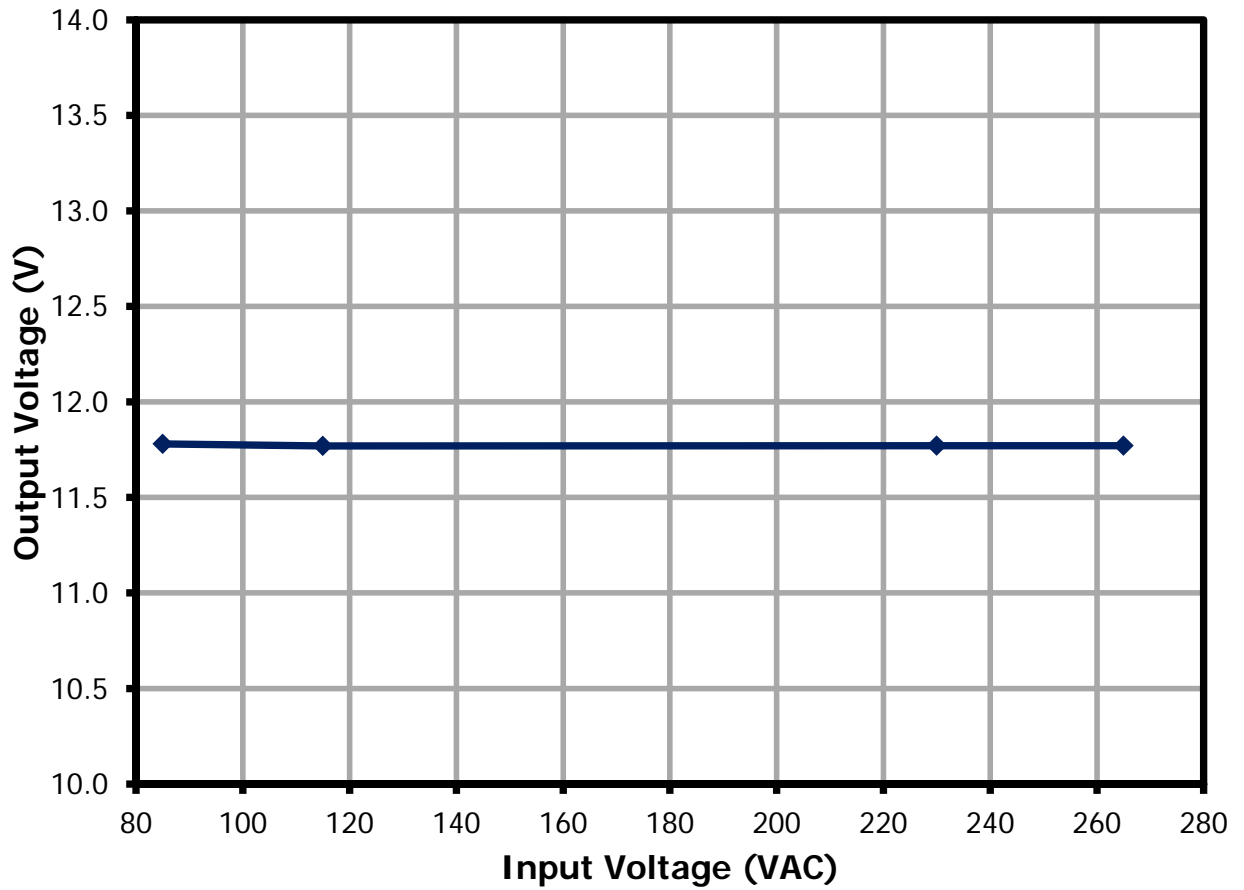

Figure 10 – Output Voltage vs. Input Voltage, Room Temperature.



9 Open Case Thermal Performance

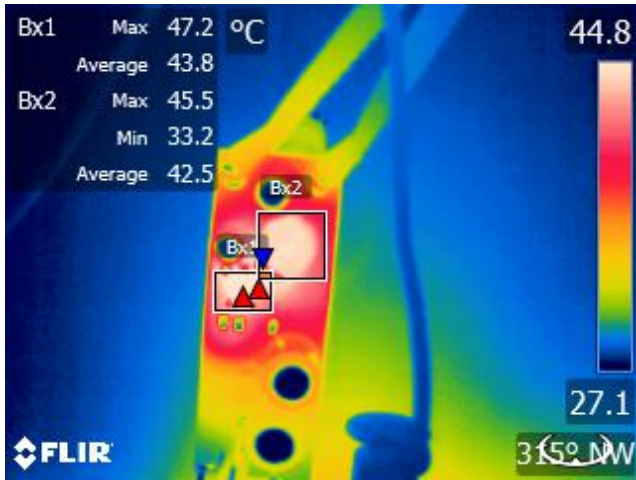

Figure 11 – LNK3204D Maximum 47.2 °C.
85 VAC, 120 mA Load.
Ambient = 27 °C.

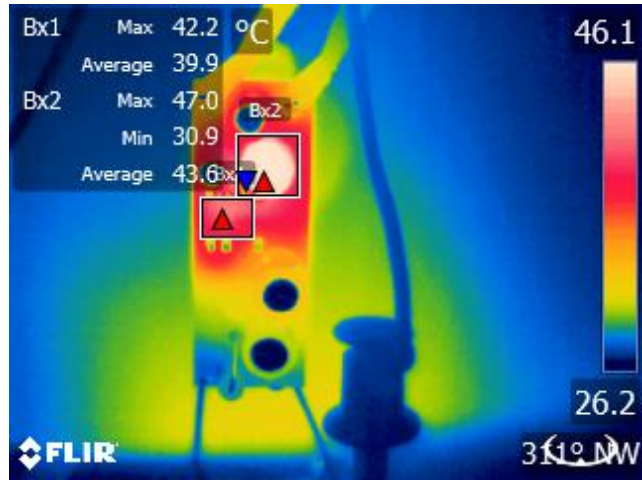

Figure 12 – LNK3204D Maximum 42.2 °C.
265 VAC, 120 mA Load.
Ambient = 26.3 °C.

10 Waveforms

10.1 Switching Waveforms

10.1.1 LNK3204D Waveforms

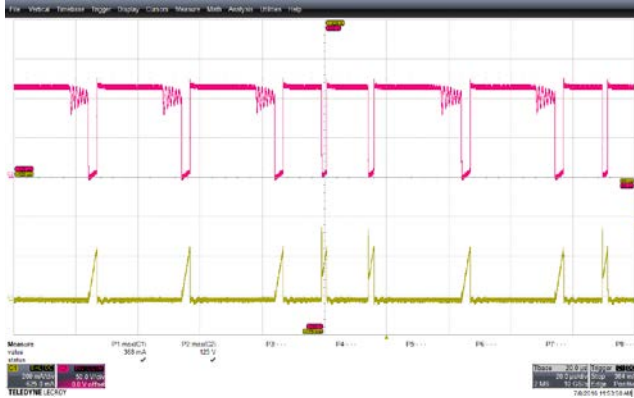

Figure 13 – Drain Voltage and Current Waveforms.
85 VAC, 120 mA Output.
Upper: V_{DRAIN} , 50 V, 20 μ s / div.
Lower: I_{DRAIN} , 200 mA / div.

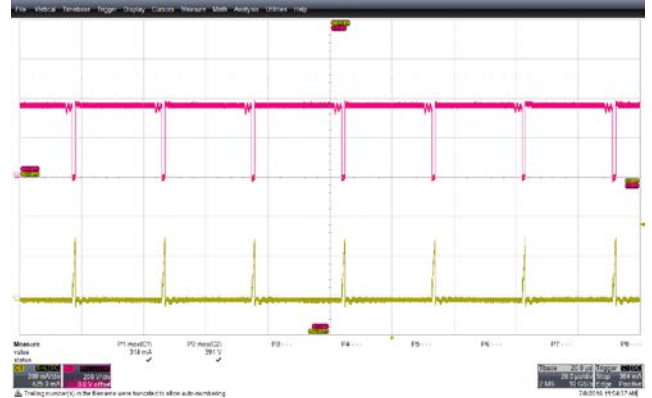

Figure 14 – Drain Voltage and Current Waveforms.
265 VAC, 120 mA Output.
 $V_{DS(Max)}$: 391 V.
Upper: V_{DRAIN} , 200 V, 20 μ s / div.
Lower: I_{DRAIN} , 200 mA / div.

10.1.2 LNK3204D Drain Voltage and Current Waveforms During Start-up

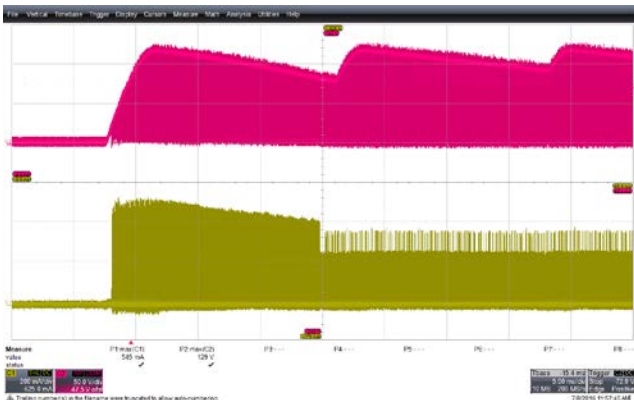

Figure 15 – Drain Voltage and Current Waveforms.
85 VAC, 120 mA Output.
Upper: V_{DRAIN} , 50 V, 5 ms / div.
Lower: I_{DRAIN} , 200 mA / div.

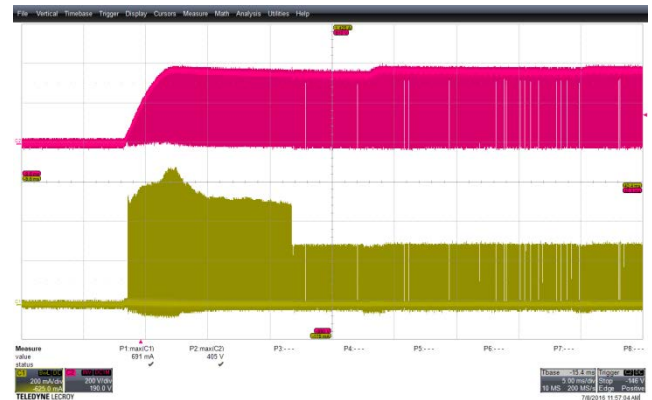

Figure 16 – Drain Voltage and Current Waveforms.
265 VAC, 120 mA Output.
 $V_{DS(MAX)}$: 405 V.
Upper: V_{DRAIN} , 200 V, 5 ms / div.
Lower: I_{DRAIN} , 200 mA / div.

10.1.3 Drain Current and Output Waveform During Output Short

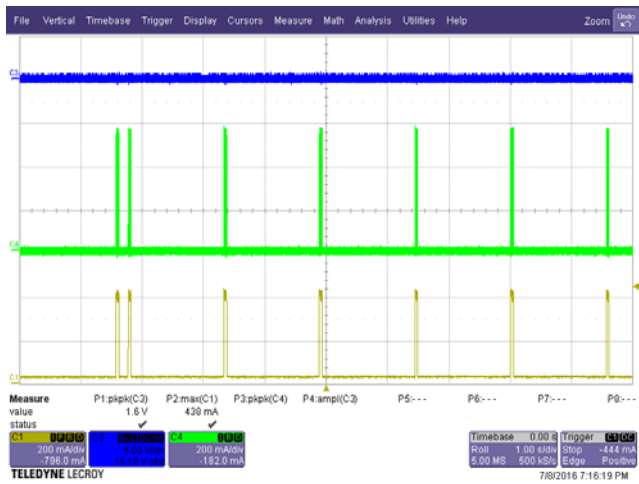

Figure 17 – Drain Current and Output Waveforms.
85 VAC Input.
Upper: V_{OUT} , 5 V, 1s / div.
Middle: I_{DRAIN} , 200 mA / div.
Lower: I_{OUT} , 200 mA / div.

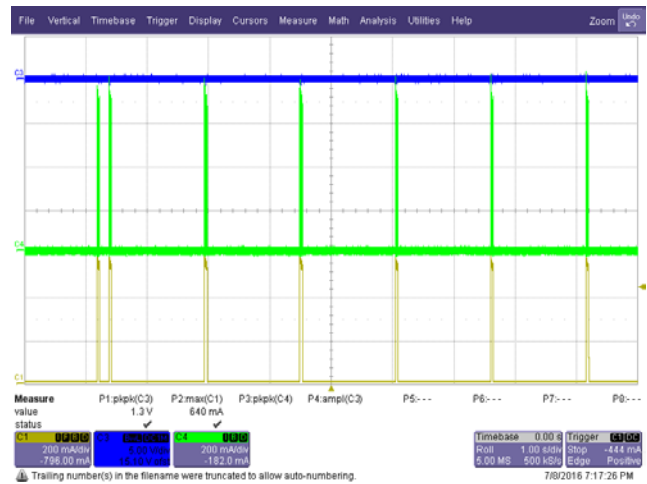

Figure 18 – Drain Voltage and Output Waveforms.
265 VAC Input.
Upper: V_{OUT} , 5 V, 1s / div.
Middle: I_{DRAIN} , 200 mA / div.
Lower: I_{OUT} , 200 mA / div.

10.1.4 Freewheeling Diode Waveforms

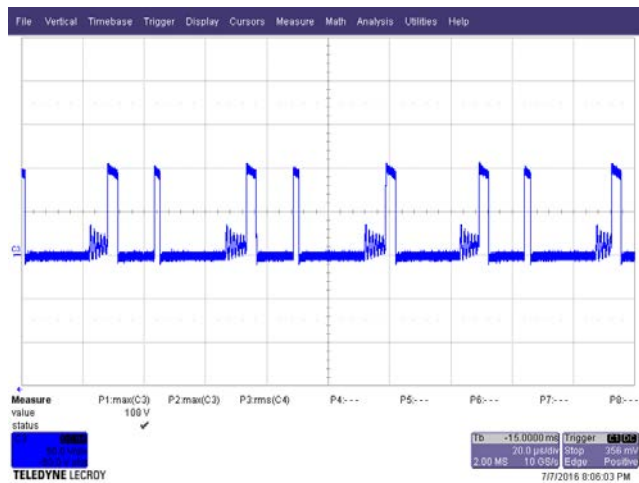

Figure 19 – Freewheeling Diode Voltage Waveforms.
85 VAC, 120 mA Output.
50 V, 20 μ s / div.

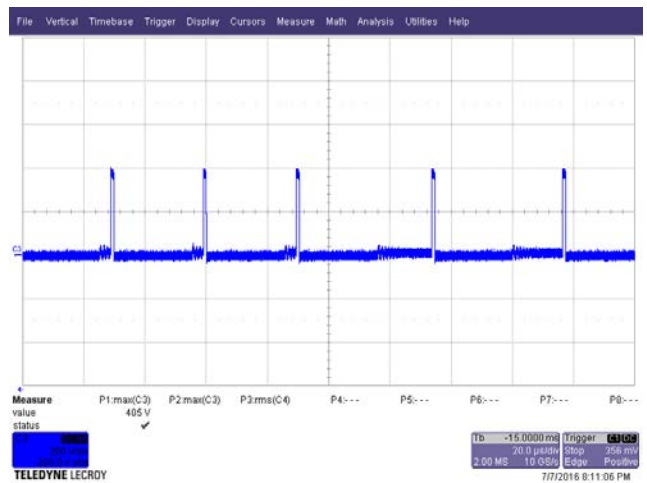

Figure 20 – Freewheeling Diode Voltage Waveforms.
265 VAC, 120 mA Output.
 V_{MAX} : 405 V.
200 V, 20 μ s / div.

10.1.5 Output Voltage and Current Waveforms During Start-Up

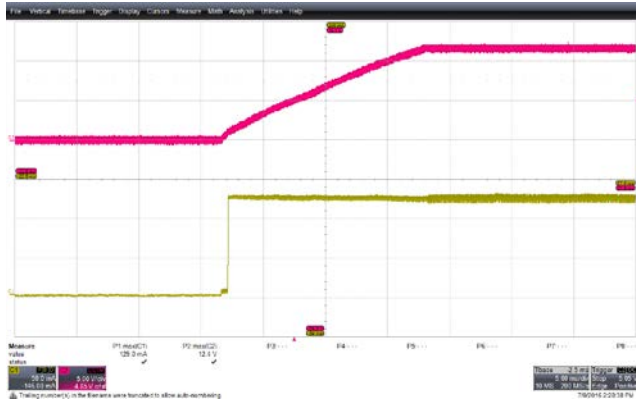

Figure 21 – Output Voltage and Current Waveforms.
85 VAC, 120 mA Output.
Blue: I_{DRAIN} , 50 mA / div.
Yellow: V_{DRAIN} , 5 V / div., 5 ms / div.

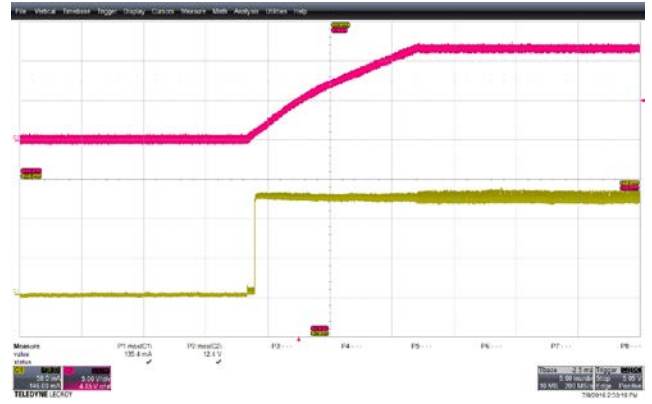

Figure 22 – Output Voltage and Current Waveforms.
265 VAC, 120 mA Output.
Blue: I_{DRAIN} , 50 mA / div.
Yellow: V_{DRAIN} , 5 V / div., 5 ms / div.

10.2 Output Ripple Measurements

11.2.1 Ripple Measurement Technique

For DC output ripple measurements, a modified oscilloscope test probe must be utilized in order to reduce spurious signals due to pick-up. Details of the probe modification are provided in the Figures below.

The 4987BA probe adapter is affixed with two capacitors tied in parallel across the probe tip. The capacitors include one (1) 0.1 $\mu\text{F}/50\text{ V}$ ceramic type and one (1) 1 $\mu\text{F}/50\text{ V}$ aluminum electrolytic. The aluminum electrolytic type capacitor is polarized, so proper polarity across DC outputs must be maintained (see below).

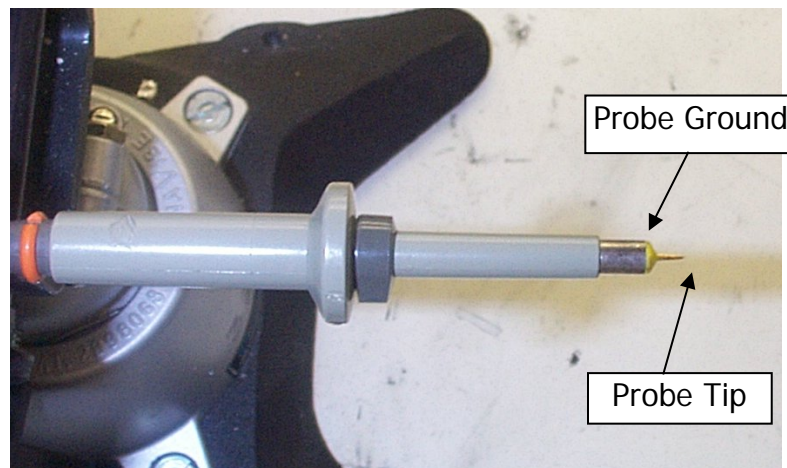

Figure 23 – Oscilloscope Probe Prepared for Ripple Measurement. (End Cap and Ground Lead Removed)

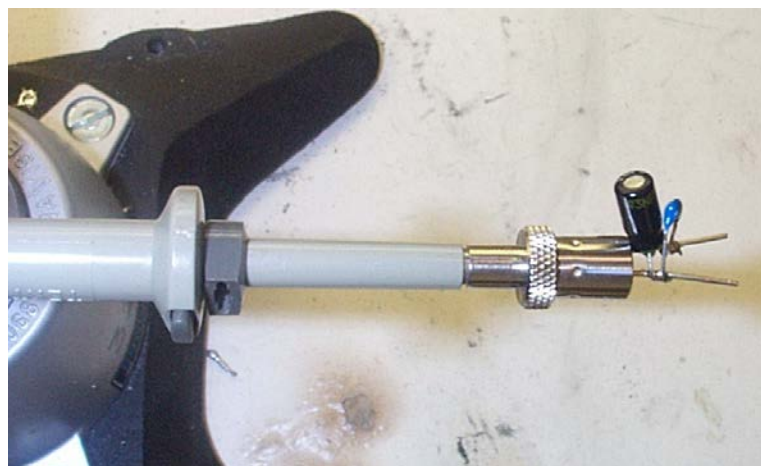

Figure 24 – Oscilloscope Probe with Probe Master (www.probemaster.com) 4987A BNC Adapter. (Modified with wires for ripple measurement, and two parallel decoupling capacitors added)

10.2.2 Measurement Results

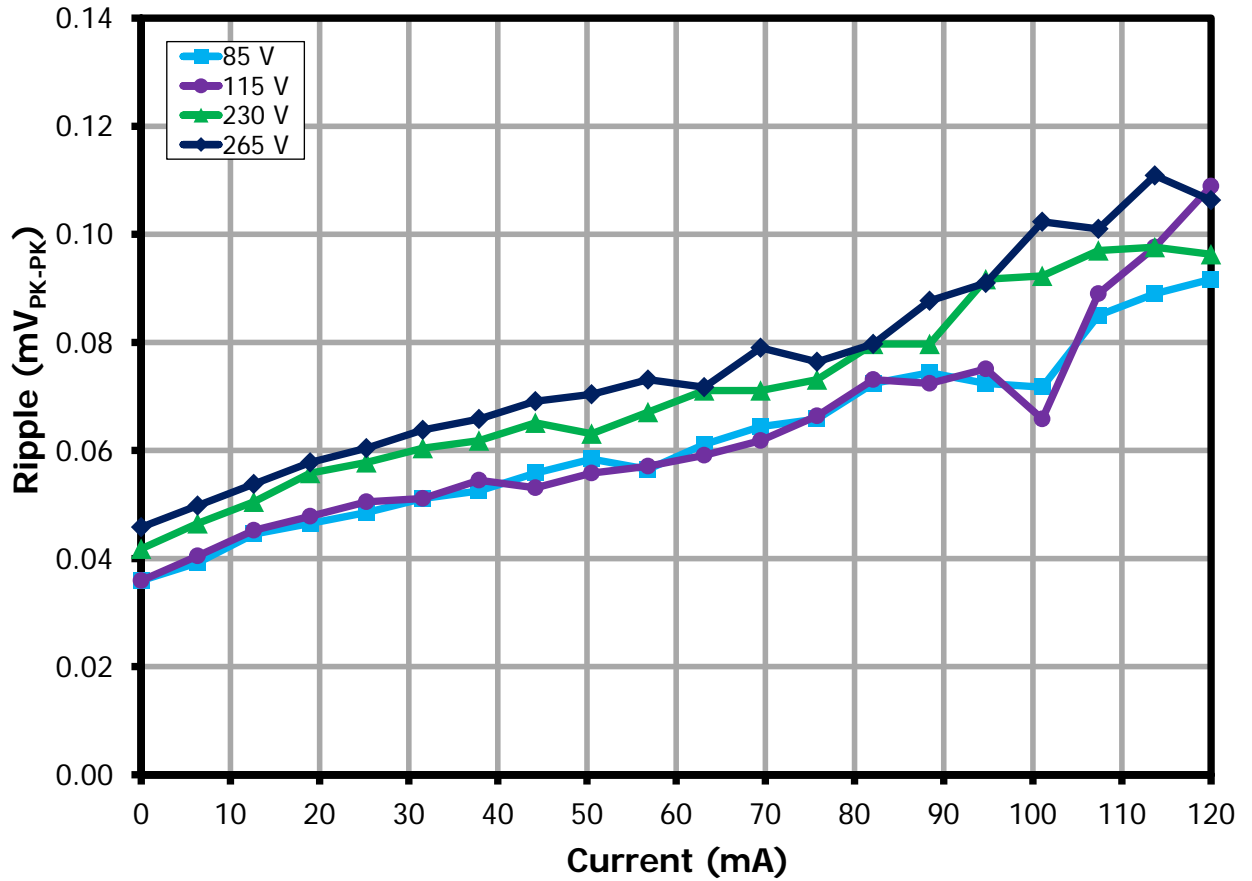

Figure 25 – Output Ripple Voltage.

85 V RIPPLE (V _{PK-PK})	115 V RIPPLE (V _{PK-PK})	230 V RIPPLE (V _{PK-PK})	265 V RIPPLE (V _{PK-PK})
0.092	0.109	0.096	0.106



10.2.3 Ripple Voltage Waveforms

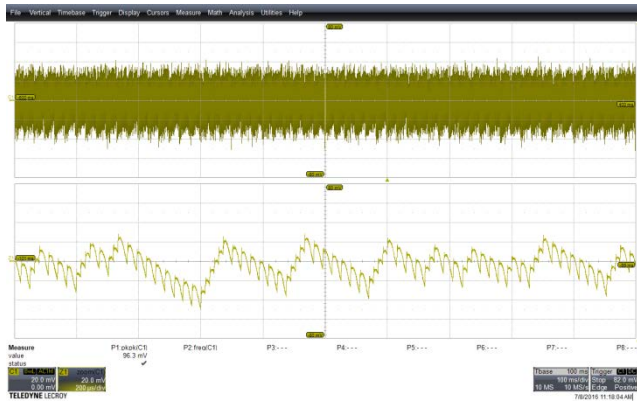

Figure 26 – Output Voltage Ripple Waveforms.
85 VAC, 120 mA Output.
20 mV, 100 ms / div.; 200 μ s / div.
 V_{PK-PK} : 96.3 mV.

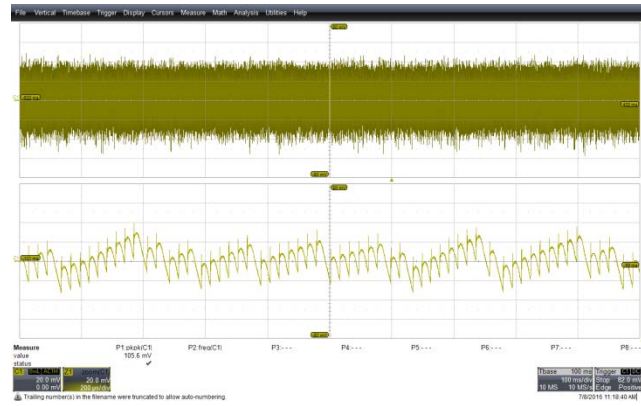

Figure 27 – Output Voltage Ripple Waveforms.
265 VAC, 120 mA Output.
20 mV, 100 ms / div.; 200 μ s / div.
 V_{PK-PK} : 105.6 mV.

11 Conductive EMI

11.1 120 mA Resistive Load, Floating Output (QPK / AV)

After running for 5 minutes.

11.1.1 Line

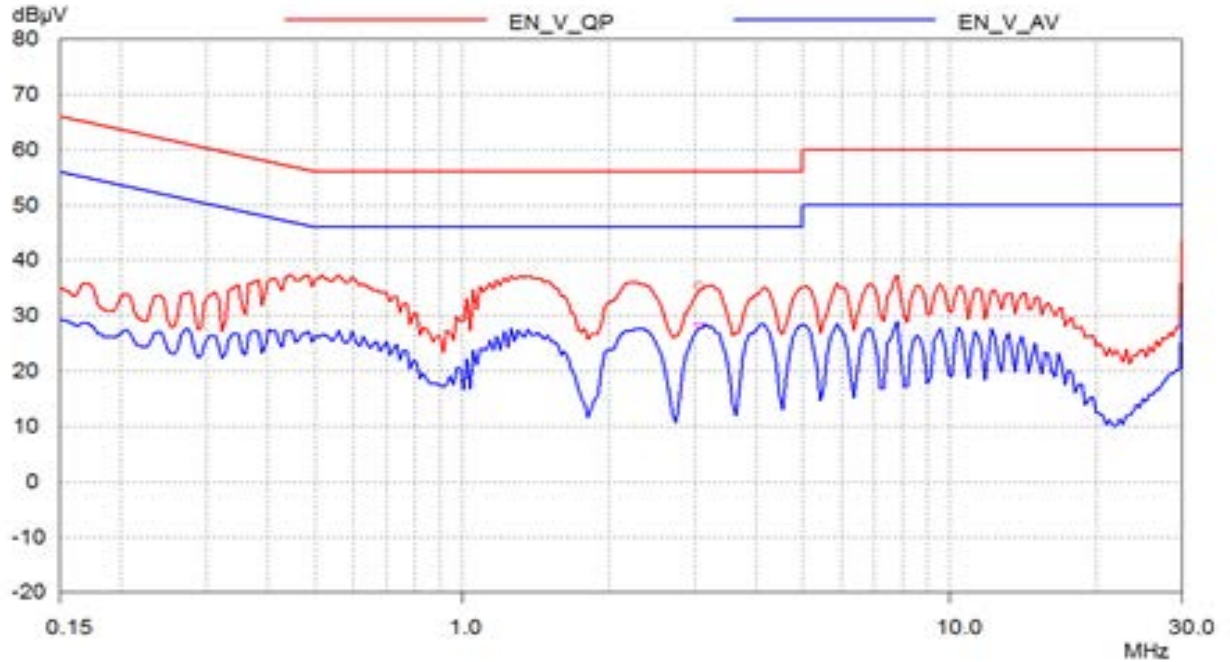

Figure 28 – Floating Ground EMI at 230 VAC.



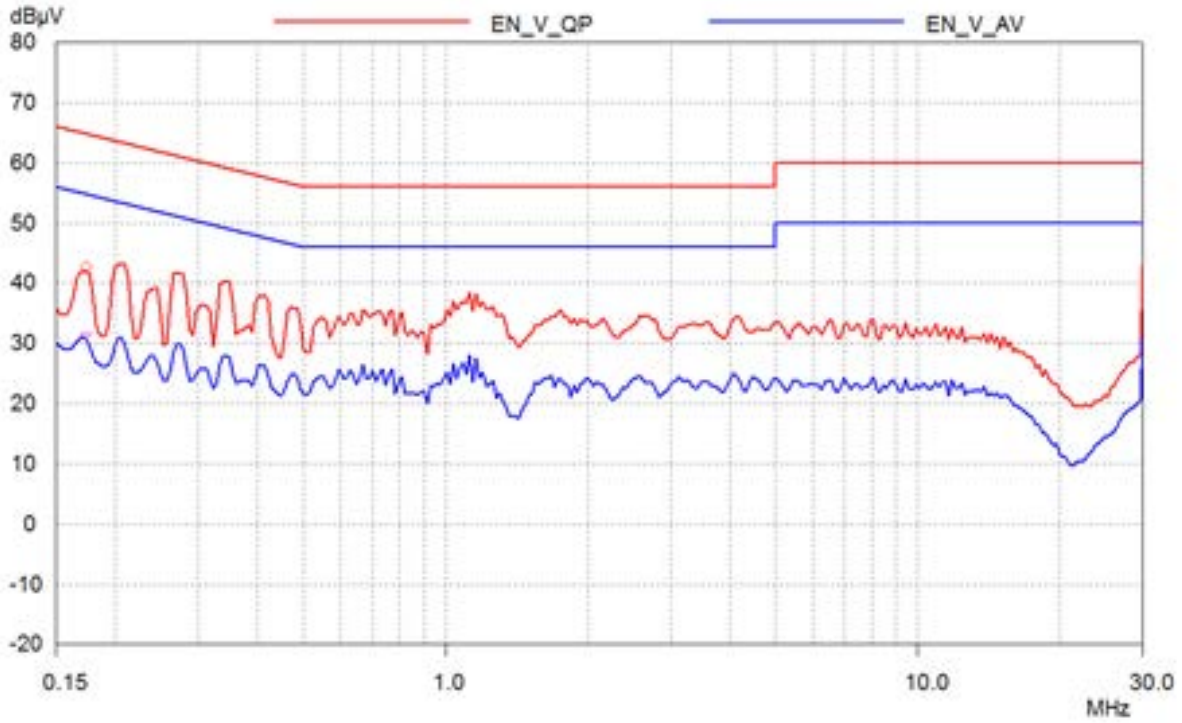

Figure 29 – Floating Ground at 115 VAC.

11.1.2 Neutral

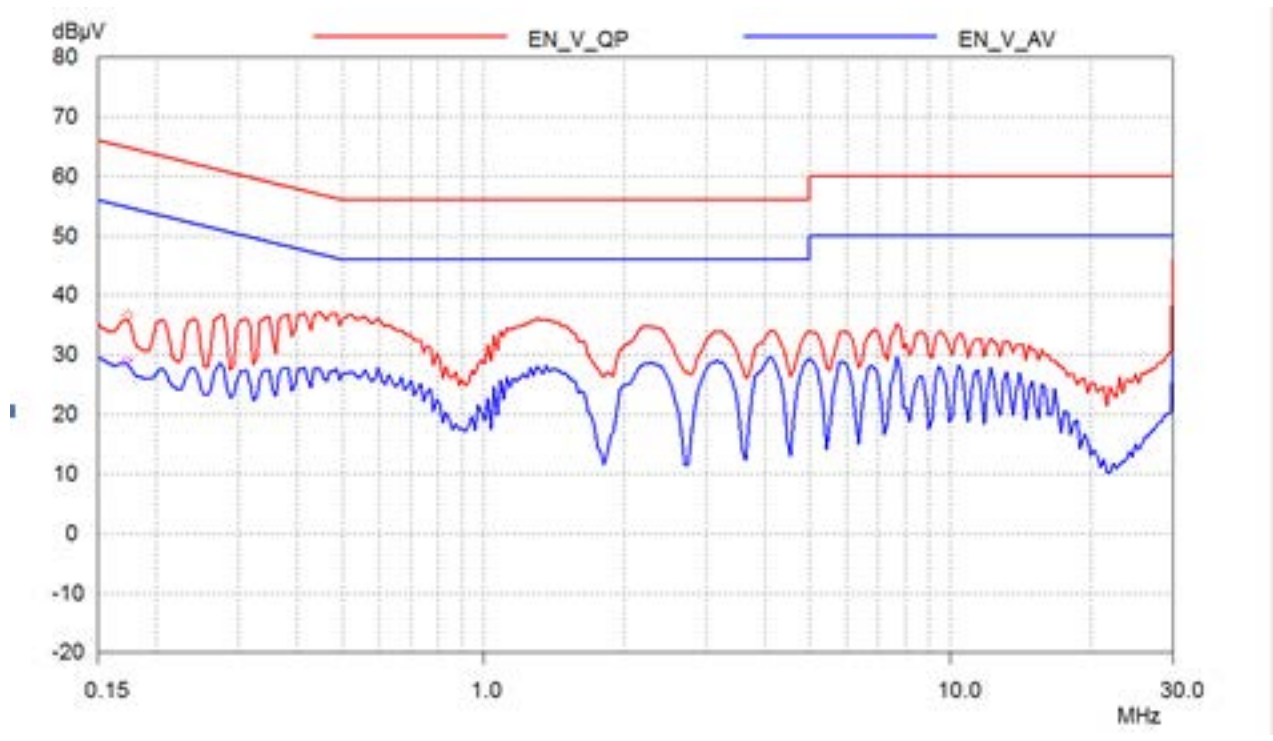

Figure 30 – Floating Ground at 230 VAC.



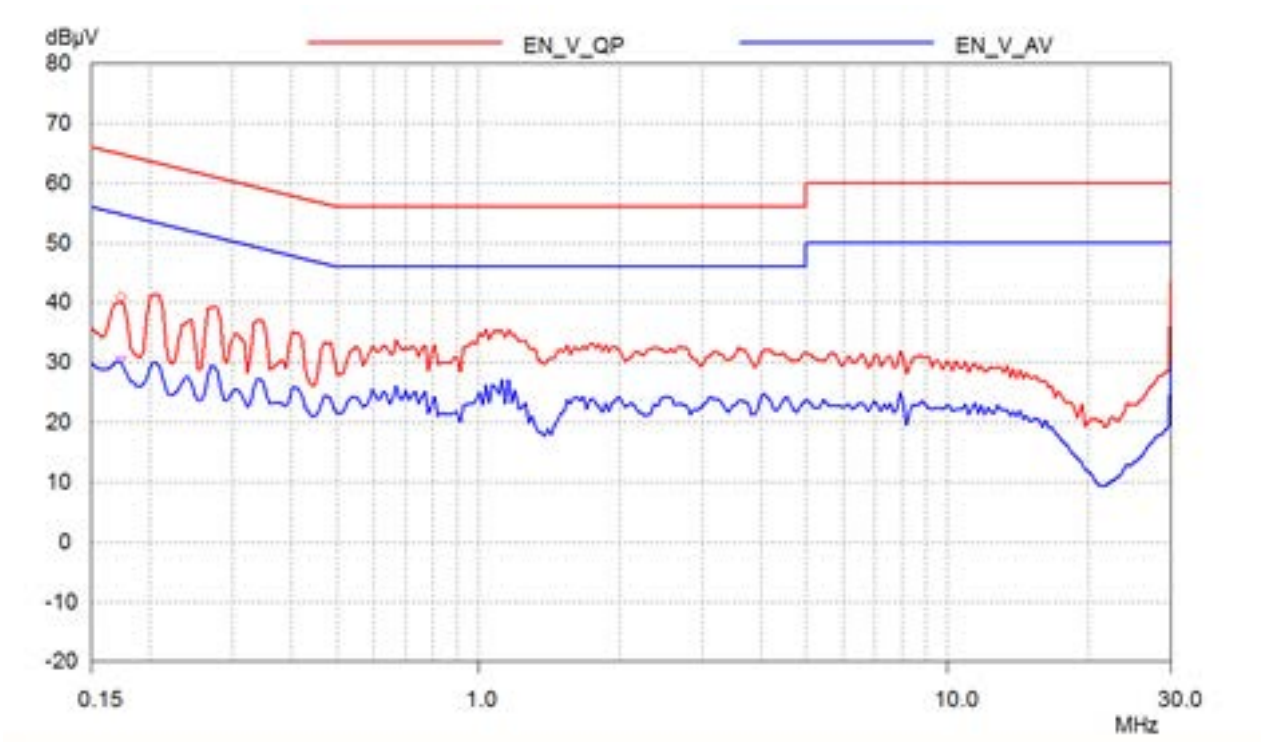

Figure 31 – Floating Ground at 115 VAC.

12 Lighting Surge

12.1 *Differential Mode Test*

Passed ± 1 kV surge test.



13 Revision History

Date	Author	Revision	Description & Changes	Reviewed
08-Nov-16	JW	1.0	Initial Release.	Apps & Mktg



For the latest updates, visit our website: www.power.com

Power Integrations reserves the right to make changes to its products at any time to improve reliability or manufacturability. Power Integrations does not assume any liability arising from the use of any device or circuit described herein. POWER INTEGRATIONS MAKES NO WARRANTY HEREIN AND SPECIFICALLY DISCLAIMS ALL WARRANTIES INCLUDING, WITHOUT LIMITATION, THE IMPLIED WARRANTIES OF MERCHANTABILITY, FITNESS FOR A PARTICULAR PURPOSE, AND NON-INFRINGEMENT OF THIRD PARTY RIGHTS.

PATENT INFORMATION

The products and applications illustrated herein (including transformer construction and circuits' external to the products) may be covered by one or more U.S. and foreign patents, or potentially by pending U.S. and foreign patent applications assigned to Power Integrations. A complete list of Power Integrations' patents may be found at www.power.com. Power Integrations grants its customers a license under certain patent rights as set forth at <http://www.power.com/ip.htm>.

The PI Logo, TOPSwitch, TinySwitch, LinkSwitch, LYTSwitch, InnoSwitch, DPA-Switch, PeakSwitch, CAPZero, SENZero, LinkZero, HiperPFS, HiperTFS, HiperLCS, Ospeed, EcoSmart, Clampless, E-Shield, Filterfuse, FluxLink, StackFET, PI Expert and PI FACTS are trademarks of Power Integrations, Inc. Other trademarks are property of their respective companies. ©Copyright 2015 Power Integrations, Inc.

Power Integrations Worldwide Sales Support Locations

WORLD HEADQUARTERS

5245 Hellyer Avenue
San Jose, CA 95138, USA.
Main: +1-408-414-9200
Customer Service:
Phone: +1-408-414-9665
Fax: +1-408-414-9765
e-mail: usasales@powerint.com

CHINA (SHANGHAI)

Rm 2410, Charity Plaza, No. 88,
North Caoxi Road,
Shanghai, PRC 200030
Phone: +86-21-6354-6323
Fax: +86-21-6354-6325
e-mail: chinasales@powerint.com

CHINA (SHENZHEN)

17/F, Hivac Building, No. 2, Keji
Nan 8th Road, Nanshan District,
Shenzhen, China, 518057
Phone: +86-755-8672-8689
Fax: +86-755-8672-8690
e-mail: chinasales@powerint.com

GERMANY

Lindwurmstrasse 114
80337, Munich
Germany
Phone: +49-895-527-39110
Fax: +49-895-527-39200
e-mail: eurosales@powerint.com

INDIA

#1, 14th Main Road
Vasanthanagar
Bangalore-560052
India
Phone: +91-80-4113-8020
Fax: +91-80-4113-8023
e-mail: indiasales@powerint.com

ITALY

Via Milanese 20, 3rd. Fl.
20099 Sesto San Giovanni
(MI) Italy
Phone: +39-024-550-8701
Fax: +39-028-928-6009
e-mail: eurosales@powerint.com

JAPAN

Kosei Dai-3 Building
2-12-11, Shin-Yokohama,
Kohoku-ku, Yokohama-shi,
Kanagawa 222-0033
Japan
Phone: +81-45-471-1021
Fax: +81-45-471-3717
e-mail: japansales@powerint.com

KOREA

RM 602, 6FL
Korea City Air Terminal B/D,
159-6
Samsung-Dong, Kangnam-Gu,
Seoul, 135-728 Korea
Phone: +82-2-2016-6610
Fax: +82-2-2016-6630
e-mail: koreasales@powerint.com

SINGAPORE

51 Newton Road,
#19-01/05 Goldhill Plaza
Singapore, 308900
Phone: +65-6358-2160
Fax: +65-6358-2015
e-mail: singaporesales@powerint.com

TAIWAN

5F, No. 318, Nei Hu Rd.,
Sec. 1
Nei Hu District
Taipei 11493, Taiwan R.O.C.
Phone: +886-2-2659-4570
Fax: +886-2-2659-4550
e-mail: taiwansales@powerint.com

UK

First Floor, Unit 15, Meadway
Court, Rutherford Close,
Stevenage, Herts. SG1 2EF
United Kingdom
Phone: +44 (0) 1252-730-141
Fax: +44 (0) 1252-727-689
e-mail: eurosales@powerint.com

