



Bridgelux® Gen 7 Vero® 18 Array

Product Data Sheet DSg2



Introduction

Vero® Series



Vero® Series is a revolutionary advancement in chip on board (COB) light source technology and innovation. Vero LED light sources simplify luminaire design and manufacturing processes. Vero Chip on Board (COB) LED arrays are available in four LES configurations, engineered to enable new degrees of flexibility and reliability over a broad range of electrical currents. Vero arrays deliver increased lumen density to enable improved beam control and precision lighting with 2 and 3 SDCM color control standard for clean and consistent uniform lighting.

Vero products include an onboard connector port that enables a solder-free electrical interconnect, and simple mounting features for plug-and-play installation.

Bridgelux Décor Series™ is our state-of-the-art color line designed specifically for premium applications, producing unmatched LED light quality with brilliant color-rendering options and pleasing lighting palettes. Bridgelux Décor Series color points are available on Vero® SE Series, Vero® Series, V Series™ and V Series™ HD.

Décor Series™ Class A is based on human response testing, providing color points with a combined GAI and CRI metric.

Décor Series™ Ultra products provide a high CRI of 97 and typical R9 value of 98, which emphasizes the reds and color tones to which the human eye is most receptive - perfect for the most luxurious retail shops and world renowned museums. Décor Series Ultra is designed as a replacement for halogen lamps.

Décor Series™ Food products offer color points developed to address the unique requirements of the food, grocery, and restaurant industries. Highlighting the distinctive colors and nuanced patterns found in meats and breads, the Décor Series Food products are a must have for any butcher counter or bakery.

Décor Series™ Entertainment products provide color points developed specifically for the healthcare and entertainment industries. The 5600K cool white color point combined with a CRI of 90 or 97 provides the bright white required by these industries.

Décor Series™ Street and Landmark is designed to be a direct replacement for high pressure sodium lamps.

Décor Series™ Showcase is the optimal solution for replacing ceramic metal halide lamps, incorporating the same pure white light with enhanced spectrum coverage and higher efficacy.

Features

- Efficacy of 160 lm/W typical for 3000K 80 CRI
- Lumen output performance ranges from 1,455 to 13,600 lumens
- Broad range of CCT options from 1750K to 6500K
- CRI options include minimum 65, 70, 80, 90, 95 and Class A
- Reliable operation at up to 2X nominal drive current
- Radial die pattern and improved lumen density
- Thermally isolated solder pads
- Onboard connector port
- Top side part number markings
- V_r bin code backside marking

Benefits

- Broad application coverage for interior and exterior lighting
- Flexibility for application driven lighting design requirements
- High quality true color reproduction
- Uniform consistent white light
- Flexibility in design optimization
- Enhanced ease of use and assembly
- Solderless connectivity enables plug & play installation and field upgradability
- Improved inventory management and quality control



Contents

Product Feature Map	2
Product Nomenclature	2
Product Selection Guide	3
Performance at Commonly Used Drive Currents	9
Electrical Characteristics	18
Eye Safety	19
Absolute Maximum Ratings	20
Performance Curves	21
Typical Radiation Pattern	25
Typical Color Spectrum	26
Mechanical Dimensions	27
Color Binning Information	28
Packaging and Labeling	29
Design Resources	31
Precautions	31
Disclaimers	31
About Bridgelux	32

Product Feature Map

Vero 18 is the second largest form factor in the Vero family of next generation solid state light sources. In addition to delivering the performance and light quality required for many lighting applications, Vero incorporates

several features to simplify the design integration and manufacturing process, accelerate time to market and reduce system costs. Please visit www.bridgelux.com for more information on the Vero Series family of products.

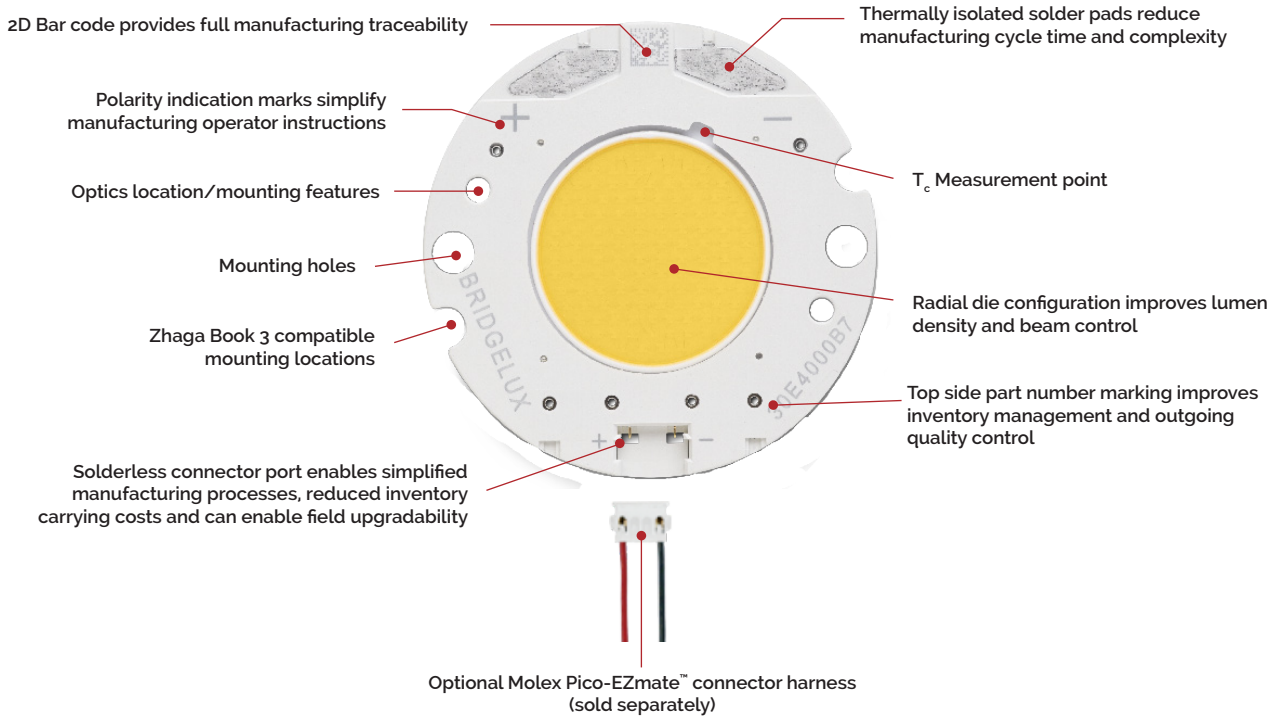

Product Nomenclature

The part number designation for Bridgelux Vero LED arrays is explained as follows:

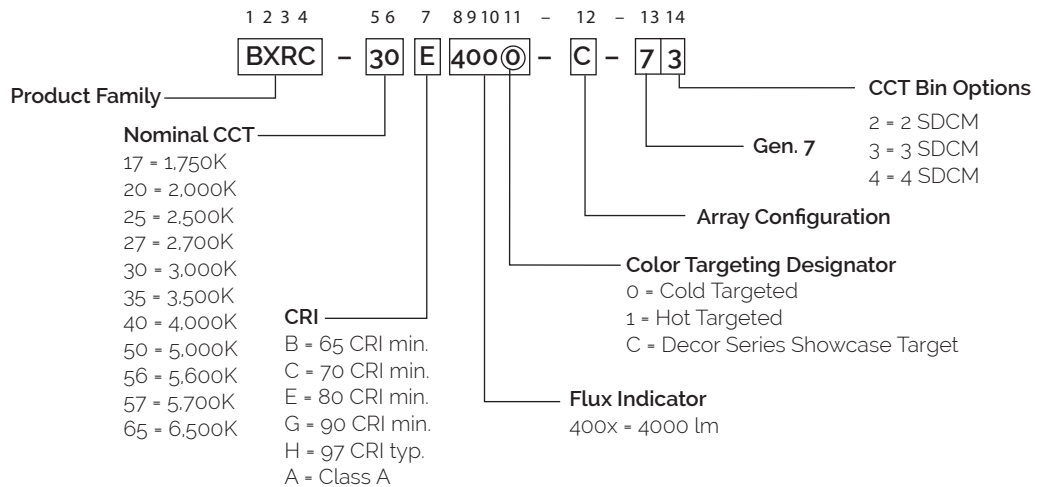

Product Selection Guide

The following product configurations are available:

Table 1: Selection Guide, Pulsed Measurement Data ($T_j = T_c = 25^\circ\text{C}$)

Part Number	Nominal CCT ¹ (K)	CRI ²	Nominal Drive Current ³ (mA)	Typical Pulsed Flux ^{4,5,6} $T_c = 25^\circ\text{C}$ (lm)	Minimum Pulsed Flux ^{6,7} $T_c = 25^\circ\text{C}$ (lm)	Typical V_f (V)	Typical Power (W)	Typical Efficacy (lm/W)
BXRC-17E4000-B-74	1750	80	900	2774	2497	34.8	31.3	89
BXRC-17E4000-C-74	1750	80	1170	3624	3261	34.8	40.7	89
BXRC-17E4000-D-74	1750	80	1050	2710	2439	29.0	30.5	89
BXRC-20B4001-C-73	2000	65	1170	6081	5473	34.8	40.7	149
BXRC-20B4001-D-73	2000	65	1050	4548	4093	29.0	30.5	149
BXRC-25E4000-B-74	2500	80	900	4484	4036	34.8	31.3	143
BXRC-25E4000-C-74	2500	80	1170	5829	5246	34.8	40.7	143
BXRC-25E4000-D-74	2500	80	1050	4360	3924	29.0	30.5	143
BXRC-27E4000-B-7x	2700	80	900	4807	4326	34.8	31.3	153
BXRC-27E4000-C-7x	2700	80	1170	6249	5624	34.8	40.7	153
BXRC-27E4000-D-7x	2700	80	1050	4673	4206	29.0	30.5	153
BXRC-27G4000-B-7x	2700	90	900	4000	3600	34.8	31.3	128
BXRC-27G4000-C-7x	2700	90	1170	5200	4680	34.8	40.7	128
BXRC-27G4000-D-7x	2700	90	1050	3889	3500	29.0	30.5	128
BXRC-27H4000-B-7x	2700	97	900	3484	3136	34.8	31.3	111
BXRC-27H4000-C-7x	2700	97	1170	4529	4076	34.8	40.7	111
BXRC-27H4000-D-7x	2700	97	1050	3387	3049	29.0	30.5	111
BXRC-30E4000-B-7x	3000	80	900	5000	4500	34.8	31.3	160
BXRC-30E4000-C-7x	3000	80	1170	6500	5850	34.8	40.7	160
BXRC-30E4000-D-7x	3000	80	1050	4861	4375	29.0	30.5	160
BXRC-30G4000-B-7x	3000	90	900	4161	3745	34.8	31.3	133
BXRC-30G4000-C-7x	3000	90	1170	5410	4869	34.8	40.7	133
BXRC-30G4000-D-7x	3000	90	1050	4046	3641	29.0	30.5	133
BXRC-30G400C-B-73	3000	90	900	3871	3484	34.8	31.3	124
BXRC-30G400C-D-73	3000	90	1050	3764	3387	29.0	30.5	124
BXRC-30H4000-B-7x	3000	97	900	3710	3339	34.8	31.3	118
BXRC-30H4000-C-7x	3000	97	1170	4823	4341	34.8	40.7	118
BXRC-30H4000-D-7x	3000	97	1050	3607	3246	29.0	30.5	118
BXRC-30A4001-B-73 ^{8,9}	3000	93	900	3758	3383	34.8	31.3	120
BXRC-30A4001-C-73 ^{8,9}	3000	93	1170	4886	4397	34.8	40.7	120
BXRC-30A4001-D-73 ^{8,9}	3000	93	1050	3654	3289	29.0	30.5	120
BXRC-35E4000-B-7x	3500	80	900	5162	4645	34.8	31.3	165
BXRC-35E4000-C-7x	3500	80	1170	6710	6039	34.8	40.7	165
BXRC-35E4000-D-7x	3500	80	1050	5018	4516	29.0	30.5	165

Notes for Table 1:

- Nominal CCT as defined by ANSI C78.377-2011. Products with a CCT of 5000K-6500K are hot targeted to $T_c = 85^\circ\text{C}$.
- CRI values are typical for Decor Series Ultra and Decor Series Class A products. CRI values are minimums for all other products. Minimum Rg value for 80 CRI products is 0, the minimum Rg value for 90 CRI products is 50, the minimum Rg value for 97 CRI products is 93. Bridgelux maintains a ± 3 tolerance on CRI and Rg values.
- Drive current is referred to as nominal drive current.
- Products tested under pulsed condition (10ms pulse width) at nominal test current where T_j (junction temperature) - T_c (case temperature) = 25°C .
- Typical performance values are provided as a reference only and are not a guarantee of performance.
- Bridgelux maintains a $\pm 7\%$ tolerance on flux measurements.
- Minimum flux values at the nominal test current are guaranteed by 100% test.
- Nominal CCT is defined by the Lighting Research Center's Class A definition. The center of the Class A color bin is on the corresponding isothermal line.
- GAI value is 80. To help ensure optimal fixture level performance, GAI is measured at the fixture level, on axis, at a case temperature of 70°C . GAI may vary depending on fixture design and performance.

Product Selection Guide

Table 1: Selection Guide, Pulsed Measurement Data ($T_j = T_c = 25^\circ\text{C}$) (continued)

Part Number	Nominal CCT ¹ (K)	CRI ²	Nominal Drive Current ³ (mA)	Typical Pulsed Flux ^{4,5,6} $T_c = 25^\circ\text{C}$ (lm)	Minimum Pulsed Flux ^{6,7} $T_c = 25^\circ\text{C}$ (lm)	Typical V_f (V)	Typical Power (W)	Typical Efficacy (lm/W)
BXRC-35G4000-B-7x	3500	90	900	4291	3861	34.8	31.3	137
BXRC-35G4000-C-7x	3500	90	1170	5578	5020	34.8	40.7	137
BXRC-35G4000-D-7x	3500	90	1050	4171	3754	29.0	30.5	137
BXRC-35A4001-B-73 ^{8,9}	3500	93	900	4040	3636	34.8	31.3	129
BXRC-35A4001-C-73 ^{8,9}	3500	93	1170	5252	4727	34.8	40.7	129
BXRC-35A4001-D-73 ^{8,9}	3500	93	1050	3928	3535	29.0	30.5	129
BXRC-40E4000-B-7x	4000	80	900	5194	4674	34.8	31.3	166
BXRC-40E4000-C-7x	4000	80	1170	6752	6077	34.8	40.7	166
BXRC-40E4000-D-7x	4000	80	1050	5050	4545	29.0	30.5	166
BXRC-40G4000-B-7x	4000	90	900	4452	4007	34.8	31.3	142
BXRC-40G4000-C-7x	4000	90	1170	5787	5209	34.8	40.7	142
BXRC-40G4000-D-7x	4000	90	1050	4328	3895	29.0	30.5	142
BXRC-40H4000-B-73	4000	97	900	3821	3439	34.8	31.3	122
BXRC-40H4000-C-73	4000	97	1170	4967	4471	34.8	40.7	122
BXRC-40H4000-D-73	4000	97	1050	3715	3343	29.0	30.5	122
BXRC-40A4001-B-73 ^{8,9}	4000	93	900	4322	3890	34.8	31.3	138
BXRC-40A4001-C-73 ^{8,9}	4000	93	1170	5619	5057	34.8	40.7	138
BXRC-40A4001-D-73 ^{8,9}	4000	93	1050	4202	3782	29.0	30.5	138
BXRC-50C4001-B-7x	5000	70	900	5710	5139	34.8	31.3	182
BXRC-50C4001-C-7x	5000	70	1170	7423	6681	34.8	40.7	182
BXRC-50C4001-D-7x	5000	70	1050	5551	4996	29.0	30.5	182
BXRC-50E4001-B-7x	5000	80	900	5355	4820	34.8	31.3	171
BXRC-50E4001-C-7x	5000	80	1170	6962	6265	34.8	40.7	171
BXRC-50E4001-D-7x	5000	80	1050	5206	4686	29.0	30.5	171
BXRC-50G4001-B-7x	5000	90	900	4549	4094	34.8	31.3	145
BXRC-50G4001-C-7x	5000	90	1170	5913	5322	34.8	40.7	145
BXRC-50G4001-D-7x	5000	90	1050	4422	3980	29.0	30.5	145
BXRC-56G4000-B-74	5600	90	900	4774	4297	34.8	31.3	152
BXRC-56G4000-C-74	5600	90	1170	6207	5586	34.8	40.7	152
BXRC-56G400x-D-74	5600	90	1050	4642	4178	29.0	30.5	152
BXRC-56H4000-D-74	5600	97	1050	4015	3613	29.0	30.5	132
BXRC-57C4001-B-7x	5700	70	900	5516	4965	34.8	31.3	176
BXRC-57C4001-C-7x	5700	70	1170	7171	6454	34.8	40.7	176
BXRC-57C4001-D-7x	5700	70	1050	5363	4827	29.0	30.5	176
BXRC-57E4001-B-7x	5700	80	900	5293	4764	34.8	31.3	169
BXRC-57E4001-C-7x	5700	80	1170	6881	6193	34.8	40.7	169

Notes for Table 1:

- Nominal CCT as defined by ANSI C78.377-2011. Products with a CCT of 5000K-6500K are hot targeted to $T_c = 85^\circ\text{C}$.
- CRI values are typical for Decor Series Ultra and Decor Series Class A products. CRI values are minimums for all other products. Minimum Rg value for 80 CRI products is 0, the minimum Rg value for 90 CRI products is 50, the minimum Rg value for 97 CRI products is 93. Bridgelux maintains a ± 3 tolerance for all CRI and Rg values.
- Drive current is referred to as nominal drive current.
- Products tested under pulsed condition (10ms pulse width) at nominal test current where T_j (junction temperature) = T_c (case temperature) = 25°C .
- Typical performance values are provided as a reference only and are not a guarantee of performance.
- Bridgelux maintains a $\pm 7\%$ tolerance on flux measurements.
- Minimum flux values at the nominal test current are guaranteed by 100% test.
- Nominal CCT is defined by the Lighting Research Center's Class A definition. The center of the Class A color bin is on the corresponding isothermal line.
- GAI value is 80. To help ensure optimal fixture level performance, GAI is measured at the fixture level, on axis, at a case temperature of 70°C . GAI may vary depending on fixture design and performance.

Product Selection Guide

Table 1: Selection Guide, Pulsed Measurement Data ($T_j = T_c = 25^\circ\text{C}$) (continued)

Part Number	Nominal CCT ¹ (K)	CRI ²	Nominal Drive Current ³ (mA)	Typical Pulsed Flux ^{4,5,6} $T_c = 25^\circ\text{C}$ (lm)	Minimum Pulsed Flux ^{6,7} $T_c = 25^\circ\text{C}$ (lm)	Typical V_f (V)	Typical Power (W)	Typical Efficacy (lm/W)
BXRC-57E4001-D-7x	5700	80	1050	5146	4631	29.0	30.5	169
BXRC-65C4001-B-7x	6500	70	900	5613	5052	34.8	31.3	179
BXRC-65C4001-C-7x	6500	70	1170	7297	6567	34.8	40.7	179
BXRC-65C4001-D-7x	6500	70	1050	5457	4912	29.0	30.5	179
BXRC-65E4001-B-7x	6500	80	900	5387	4848	34.8	31.3	172
BXRC-65E4001-C-7x	6500	80	1170	7003	6303	34.8	40.7	172
BXRC-65E4001-D-7x	6500	80	1050	5237	4714	29.0	30.5	172

Notes for Table 1:

- Nominal CCT as defined by ANSI C78.377-2011. Products with a CCT of 5000K-6500K are hot targeted to $T_c = 85^\circ\text{C}$.
- CRI values are typical for Decor Series Ultra and Decor Series Class A products. CRI values are minimums for all other products. Minimum R9 value for 80 CRI products is 0, the minimum R9 value for 90 CRI products is 50, the minimum R9 value for 97 CRI products is 93. Bridgelux maintains a ± 3 tolerance for all R9 and CRI values.
- Drive current is referred to as nominal drive current.
- Products tested under pulsed condition (10ms pulse width) at nominal test current where T_j (junction temperature) - T_c (case temperature) = 25°C .
- Typical performance values are provided as a reference only and are not a guarantee of performance.
- Bridgelux maintains a $\pm 7\%$ tolerance on flux measurements.
- Minimum flux values at the nominal test current are guaranteed by 100% test.
- Nominal CCT is defined by the Lighting Research Center's Class A definition. The center of the Class A color bin is on the corresponding isothermal line.
- GAI value is 80. To help ensure optimal fixture level performance, GAI is measured at the fixture level, on axis, at a case temperature of 70°C . GAI may vary depending on fixture design and performance.

Table 2: Selection Guide, Stabilized DC Performance ($T_c = 70^\circ\text{C}$)^{7,8}

Part Number	Nominal CCT ¹ (K)	GAI ²	CRI ³	Nominal Drive Current ⁴ (mA)	Typical DC Flux ^{5,6} $T_c = 70^\circ\text{C}$ (lm)	Minimum DC Flux ^{6,9} $T_c = 70^\circ\text{C}$ (lm)	Typical V_f (V)	Typical Power (W)	Typical Efficacy (lm/W)
BXRC-30A4001-B-73	3000	80	93	900	3495	3146	34.3	30.9	112
BXRC-30A4001-C-73	3000	80	93	1170	4544	4090	34.3	40.2	112
BXRC-30A4001-D-73	3000	80	93	1050	3398	3058	28.5	29.9	112
BXRC-35A4001-B-73	3500	80	93	900	3757	3382	34.3	30.9	120
BXRC-35A4001-C-73	3500	80	93	1170	4885	4396	34.3	40.2	120
BXRC-35A4001-D-73	3500	80	93	1050	3653	3288	28.5	29.9	120
BXRC-40A4001-B-73	4000	80	93	900	4020	3618	34.3	30.9	129
BXRC-40A4001-C-73	4000	80	93	1170	5225	4703	34.3	40.2	129
BXRC-40A4001-D-73	4000	80	93	1050	3908	3517	28.5	29.9	129

Notes for Table 2:

- Nominal CCT is defined by the Lighting Research Center's Class A definition. The center of the Class A color bin is on the corresponding isothermal line.
- To help ensure optimal fixture level performance, GAI is measured at the fixture level, on axis, at a case temperature of 70°C . GAI may vary depending on fixture design and performance.
- CRI Values are specified as typical.
- Drive current is referred to as nominal drive current.
- Typical performance values are provided as a reference only and are not a guarantee of performance.
- Bridgelux maintains a $\pm 7\%$ tolerance on flux measurements.
- Typical stabilized DC performance values are provided as reference only and are not a guarantee of performance.
- Typical performance is estimated based on operation under DC (direct current) with LED array mounted onto a heat sink with thermal interface material and the case temperature maintained at specified temperature. Based on Bridgelux test setup, values may vary depending on the thermal design of the luminaire and/or the exposed environment to which the product is subjected.
- Minimum flux values at elevated temperatures are provided for reference only and are not guaranteed by 100% production testing. Based on Bridgelux test setup, values may vary depending on the thermal design of the luminaire and/or the exposed environment to which the product is subjected.

Product Selection Guide

Table 3: Selection Guide, Stabilized DC Performance ($T_c = 85^\circ\text{C}$)^{4,5}

Part Number	Nominal CCT ¹ (K)	CRI ²	Nominal Drive Current ³ (mA)	Typical DC Flux ^{4,5} $T_c = 85^\circ\text{C}$ (lm)	Minimum DC Flux ⁶ $T_c = 85^\circ\text{C}$ (lm)	Typical V_f (V)	Typical Power (W)	Typical Efficacy (lm/W)
BXRC-17E4000-B-74	1750	80	900	2497	2247	33.9	30.7	82
BXRC-17E4000-C-74	1750	80	1170	3261	2935	33.9	39.9	82
BXRC-17E4000-D-74	1750	80	1050	2439	2195	28.1	29.5	83
BXRC-20B4001-C-73	2000	65	1170	5473	4926	34.1	39.9	138
BXRC-20B4001-D-73	2000	65	1050	4093	3684	28.1	29.5	139
BXRC-25E4000-B-74	2500	80	900	4036	3632	33.9	30.7	132
BXRC-25E4000-C-74	2500	80	1170	5246	4722	33.9	39.9	132
BXRC-25E4000-D-74	2500	80	1050	3924	3531	28.1	29.5	133
BXRC-27E4000-B-7x	2700	80	900	4326	3893	33.9	30.7	142
BXRC-27E4000-C-7x	2700	80	1170	5624	5061	33.9	39.9	142
BXRC-27E4000-D-7x	2700	80	1050	4206	3785	28.3	29.7	143
BXRC-27G4000-B-7x	2700	90	900	3600	3240	33.9	30.7	118
BXRC-27G4000-C-7x	2700	90	1170	4680	4212	33.9	39.9	118
BXRC-27G4000-D-7x	2700	90	1050	3500	3150	28.3	29.7	119
BXRC-27H4000-B-7x	2700	97	900	3136	2822	33.9	30.7	103
BXRC-27H4000-C-7x	2700	97	1170	4076	3669	33.9	39.9	103
BXRC-27H4000-D-7x	2700	97	1050	3049	2744	28.3	29.7	103
BXRC-30E4000-B-7x	3000	80	900	4500	4050	33.9	30.7	147
BXRC-30E4000-C-7x	3000	80	1170	5850	5265	33.9	39.9	147
BXRC-30E4000-D-7x	3000	80	1050	4375	3938	28.3	29.7	148
BXRC-30G4000-B-7x	3000	90	900	3745	3371	33.9	30.7	123
BXRC-30G4000-C-7x	3000	90	1170	4869	4382	33.9	39.9	123
BXRC-30G4000-D-7x	3000	90	1050	3641	3277	28.3	29.7	123
BXRC-30G400C-B-73	3000	90	900	3484	3136	34.1	30.7	114
BXRC-30G400C-D-73	3000	90	1050	3387	3049	28.3	29.7	115
BXRC-30H4000-B-7x	3000	97	900	3339	3005	33.9	30.7	109
BXRC-30H4000-C-7x	3000	97	1170	4341	3906	33.9	39.9	109
BXRC-30H4000-D-7x	3000	97	1050	3246	2922	28.3	29.7	110
BXRC-30A4001-B-73 ^{7,8}	3000	93	900	3383	3044	33.9	30.7	111
BXRC-30A4001-C-73 ^{7,8}	3000	93	1170	4397	3958	33.9	39.9	111
BXRC-30A4001-D-73 ^{7,8}	3000	93	1050	3289	2960	28.3	29.7	111
BXRC-35E4000-B-7x	3500	80	900	4645	4181	33.9	30.7	152
BXRC-35E4000-C-7x	3500	80	1170	6039	5435	33.9	39.9	152
BXRC-35E4000-D-7x	3500	80	1050	4516	4065	28.3	29.7	153
BXRC-35G4000-B-7x	3500	90	900	3861	3475	33.9	30.7	127

Notes for Table 3:

- Nominal CCT as defined by ANSI C78.377-2011. Products with a CCT of 5000K-6500K are hot targeted to $T_c = 85^\circ\text{C}$.
- All CRI values are measured at $T_c = 25^\circ\text{C}$. CRI values are typical for Decor Series Ultra and Decor Series Class A products. CRI values are minimums for all other products. Minimum Rg value for 80 CRI products is 0, the minimum Rg value for 90 CRI products is 50, the minimum Rg value for 97 CRI products is 93. Bridgelux maintains a ± 3 tolerance for all CRI and Rg values.
- Drive current is referred to as nominal drive current.
- Typical stabilized DC performance values are provided as reference only and are not a guarantee of performance.
- Typical performance is estimated based on operation under DC (direct current) with LED array mounted onto a heat sink with thermal interface material and the case temperature maintained at 85°C . Based on Bridgelux test setup, values may vary depending on the thermal design of the luminaire and/or the exposed environment to which the product is subjected.
- Minimum flux values at elevated temperatures are provided for reference only and are not guaranteed by 100% production testing. Based on Bridgelux test setup, values may vary depending on the thermal design of the luminaire and/or the exposed environment to which the product is subjected.
- Nominal CCT is defined by the Lighting Research Center's Class A definition. The center of the Class A color bin is on the corresponding isothermal line.
- GAI value is 80. To help ensure optimal fixture level performance, GAI is measured at the fixture level, on axis, at a case temperature of 70°C . GAI may vary depending on fixture design and performance.

Product Selection Guide

Table 3: Selection Guide, Stabilized DC Performance ($T_c = 85^\circ\text{C}$)^{4,5} (continued)

Part Number	Nominal CCT ¹ (K)	CRI ²	Nominal Drive Current ³ (mA)	Typical DC Flux ^{4,5} $T_c = 85^\circ\text{C}$ (lm)	Minimum DC Flux ⁶ $T_c = 85^\circ\text{C}$ (lm)	Typical V_f (V)	Typical Power (W)	Typical Efficacy (lm/W)
BXRC-35G4000-C-7x	3500	90	1170	5020	4518	33.9	39.7	127
BXRC-35G4000-D-7x	3500	90	1050	3754	3379	28.3	29.7	127
BXRC-35A4001-B-73 ^{7,8}	3500	93	900	3636	3273	33.9	30.5	119
BXRC-35A4001-C-73 ^{7,8}	3500	93	1170	4727	4254	33.9	39.7	119
BXRC-35A4001-D-73 ^{7,8}	3500	93	1050	3535	3182	28.3	29.7	120
BXRC-40E4000-B-7x	4000	80	900	4674	4207	33.9	30.5	153
BXRC-40E4000-C-7x	4000	80	1170	6077	5469	33.9	39.7	153
BXRC-40E4000-D-7x	4000	80	1050	4545	4090	28.3	29.7	154
BXRC-40G4000-B-7x	4000	90	900	4007	3606	33.9	30.5	131
BXRC-40G4000-C-7x	4000	90	1170	5209	4688	33.9	39.7	131
BXRC-40G4000-D-7x	4000	90	1050	3895	3506	28.3	29.7	132
BXRC-40H4000-B-7x	4000	97	900	3439	3095	33.9	30.5	113
BXRC-40H4000-C-7x	4000	97	1170	4471	4024	33.9	39.7	113
BXRC-40H4000-D-7x	4000	97	1050	3343	3009	28.1	29.5	113
BXRC-40A4001-B-73 ^{7,8}	4000	93	900	3890	3501	33.9	30.5	127
BXRC-40A4001-C-73 ^{7,8}	4000	93	1170	5057	4551	33.9	39.7	127
BXRC-40A4001-D-73 ^{7,8}	4000	93	1050	3782	3404	28.3	29.7	128
BXRC-50C4001-B-7x	5000	70	900	5139	4625	33.9	30.5	168
BXRC-50C4001-C-7x	5000	70	1170	6681	6013	33.9	39.7	168
BXRC-50C4001-D-7x	5000	70	1050	4996	4497	28.3	29.7	169
BXRC-50E4001-B-7x	5000	80	900	4820	4338	33.9	30.5	158
BXRC-50E4001-C-7x	5000	80	1170	6265	5639	33.9	39.7	158
BXRC-50E4001-D-7x	5000	80	1050	4686	4217	28.3	29.7	159
BXRC-50G4001-B-7x	5000	90	900	4094	3684	33.9	30.5	134
BXRC-50G4001-C-7x	5000	90	1170	5322	4790	33.9	39.7	134
BXRC-50G4001-D-7x	5000	90	1050	3980	3582	28.3	29.7	135
BXRC-56G4000-B-74	5600	90	900	4297	3867	33.9	30.5	141
BXRC-56G4000-C-74	5600	90	1170	5586	5027	33.9	39.7	141
BXRC-56G400x-D-74	5600	90	1050	4178	3760	28.3	29.7	142
BXRC-56H4000-D-74	5600	97	1050	3613	3252	28.3	29.7	122
BXRC-57C4001-B-7x	5700	70	900	4965	4468	33.9	30.5	163
BXRC-57C4001-C-7x	5700	70	1170	6454	5809	33.9	39.7	163
BXRC-57C4001-D-7x	5700	70	1050	4827	4344	28.3	29.7	164
BXRC-57E4001-B-7x	5700	80	900	4764	4287	33.9	30.5	156
BXRC-57E4001-C-7x	5700	80	1170	6193	5574	33.9	39.7	156

Notes for Table 3:

- Nominal CCT as defined by ANSI C78.377-2011. Products with a CCT of 5000K-6500K are hot targeted to $T_c = 85^\circ\text{C}$.
- All CRI values are measured at $T_s = T_c = 25^\circ\text{C}$. CRI values are typical for Decor Series Ultra and Decor Series Class A products. CRI values are minimums for all other products. Minimum R_g value for 80 CRI products is 0, the minimum R_g value for 90 CRI products is 50, the minimum R_g value for 97 CRI products is 93. Bridgelux maintains a ± 3 tolerance for all CRI and R_g values.
- Drive current is referred to as nominal drive current.
- Typical stabilized DC performance values are provided as reference only and are not a guarantee of performance.
- Typical performance is estimated based on operation under DC (direct current) with LED array mounted onto a heat sink with thermal interface material and the case temperature maintained at 85°C . Based on Bridgelux test setup, values may vary depending on the thermal design of the luminaire and/or the exposed environment to which the product is subjected.
- Minimum flux values at elevated temperatures are provided for reference only and are not guaranteed by 100% production testing. Based on Bridgelux test setup, values may vary depending on the thermal design of the luminaire and/or the exposed environment to which the product is subjected.
- Nominal CCT is defined by the Lighting Research Center's Class A definition. The center of the Class A color bin is on the corresponding isothermal line.
- GAI value is 80. To help ensure optimal fixture level performance, GAI is measured at the fixture level, on axis, at a case temperature of 70°C . GAI may vary depending on fixture design and performance.

Product Selection Guide

Table 3: Selection Guide, Stabilized DC Performance ($T_c = 85^\circ\text{C}$)^{4,5}

Part Number	Nominal CCT ¹ (K)	CRI ²	Nominal Drive Current ³ (mA)	Typical DC Flux ^{4,5} $T_c = 85^\circ\text{C}$ (lm)	Minimum DC Flux ⁶ $T_c = 85^\circ\text{C}$ (lm)	Typical V_f (V)	Typical Power (W)	Typical Efficacy (lm/W)
BXRC-57E4001-D-7x	5700	80	1050	4631	4168	28.3	29.7	157
BXRC-65C4001-B-7x	6500	70	900	5052	4547	33.9	30.5	166
BXRC-65C4001-C-7x	6500	70	1170	6567	5911	33.9	39.7	166
BXRC-65C4001-D-7x	6500	70	1050	4912	4420	28.3	29.7	166
BXRC-65E4001-B-7x	6500	80	900	4848	4364	33.9	30.5	159
BXRC-65E4001-C-7x	6500	80	1170	6303	5673	33.9	39.7	159
BXRC-65E4001-D-7x	6500	80	1050	4714	4242	28.3	29.7	160

Notes for Table 3:

- Nominal CCT as defined by ANSI C78.377-2011. Products with a CCT of 5000K-6500K are hot targeted to $T_c = 85^\circ\text{C}$.
- All CRI values are measured at $T_c = T_c = 25^\circ\text{C}$. CRI values are typical for Decor Series Ultra and Decor Series Class A products. CRI values are minimums for all other products. Minimum R_g value for 80 CRI products is 0, the minimum R_g value for 90 CRI products is 50, the minimum R_g value for 97 CRI products is 93. Bridgelux maintains a ± 3 tolerance for all CRI and R_g values.
- Drive current is referred to as nominal drive current.
- Typical stabilized DC performance values are provided as reference only and are not a guarantee of performance.
- Typical performance is estimated based on operation under DC (direct current) with LED array mounted onto a heat sink with thermal interface material and the case temperature maintained at 85°C . Based on Bridgelux test setup, values may vary depending on the thermal design of the luminaire and/or the exposed environment to which the product is subjected.
- Minimum flux values at elevated temperatures are provided for reference only and are not guaranteed by 100% production testing. Based on Bridgelux test setup, values may vary depending on the thermal design of the luminaire and/or the exposed environment to which the product is subjected.
- Nominal CCT is defined by the Lighting Research Center's Class A definition. The center of the Class A color bin is on the corresponding isothermal line.
- GAI value is 80. To help ensure optimal fixture level performance, GAI is measured at the fixture level, on axis, at a case temperature of 70°C . GAI may vary depending on fixture design and performance.

Performance at Commonly Used Drive Currents

Vero LED arrays are tested to the specifications shown using the nominal drive currents in Table 1. Vero may also be driven at other drive currents dependent on specific application design requirements. The performance at any drive current can be derived from the current vs. voltage characteristics shown in Figures 1, 2 & 3 and the flux vs. current characteristics shown in Figures 4, 5 & 6. The performance at commonly used drive currents is summarized in Table 4.

Table 4: Product Performance at Commonly Used Drive Currents

Part Number	CRI	Drive Current ¹ (mA)	Typical V _f T _c = 25°C (V)	Typical Power T _c = 25°C (W)	Typical Flux ² T _c = 25°C (lm)	Typical DC Flux ³ T _c = 85°C (lm)	Typical Efficacy T _c = 25°C (lm/W)
BXRC-17E4000-B-7x	80	450	33.2	14.9	1490	1338	100
		600	34.0	20.4	1954	1753	96
		900	34.8	31.3	2774	2497	89
		1350	35.6	48.1	4126	3636	86
		1800	36.1	65.1	5310	4616	82
BXRC-17E4000-C-7x	80	585	33.2	19.4	1946	1748	100
		780	34.0	26.5	2552	2289	96
		1170	34.8	40.7	3624	3261	89
		1755	35.6	62.5	5390	4749	86
		2340	36.1	84.6	6935	6029	82
BXRC-17E4000-D-7x	80	525	27.7	14.6	1455	1307	100
		700	28.2	19.8	1909	1712	97
		1050	29.0	30.5	2710	2439	89
		1575	30.4	47.9	4031	3551	84
		2100	31.5	66.2	5187	4509	78
BXRC-20B4001-C-73	65	585	33.2	19.4	3265	2934	168
		780	34.0	26.5	4283	3841	161
		1170	34.8	40.7	6081	5473	149
		1755	35.6	62.5	9044	7969	145
		2340	36.1	84.6	11638	10117	138
BXRC-20B4001-D-73	65	525	27.7	14.6	2442	2194	168
		700	28.2	19.8	3203	2873	162
		1050	29.0	30.5	4548	4093	149
		1575	30.4	47.9	6764	5960	141
		2100	31.5	66.2	8704	7566	131
BXRC-25E4000-B-74	80	450	33.2	14.9	2408	2163	161
		600	34.0	20.4	3158	2833	155
		900	34.8	31.3	4484	4036	143
		1350	35.6	48.1	6669	5876	139
		1800	36.1	65.1	8582	7460	132
BXRC-25E4000-C-74	80	585	33.2	19.4	3130	2812	161
		780	34.0	26.5	4106	3682	155
		1170	34.8	40.7	5829	5102	143
		1755	35.6	62.5	8670	7639	139
		2340	36.1	84.6	11157	9698	132
BXRC-25E4000-D-74	80	525	27.7	14.6	2341	2103	161
		700	28.2	19.8	3070	2754	155
		1050	29.0	30.5	4360	3924	143
		1575	30.4	47.9	6484	5713	135
		2100	31.5	66.2	8344	7253	126

Notes for Table 4:

1. Alternate drive currents are provided for reference only and are not a guarantee of performance.
2. Bridgelux maintains a ± 7% tolerance on flux measurements.
3. Typical stabilized DC performance values are provided as reference only and are not a guarantee of performance.

Performance at Commonly Used Drive Currents

Table 4: Product Performance at Commonly Used Drive Currents (Continued)

Part Number	CRI	Drive Current ¹ (mA)	Typical V _f T _c = 25°C (V)	Typical Power T _c = 25°C (W)	Typical Flux ² T _c = 25°C (lm)	Typical DC Flux ³ T _c = 85°C (lm)	Typical Efficacy T _c = 25°C (lm/W)
BXRC-27E4000-B-7x	80	450	33.2	14.9	2581	2319	173
		600	34.0	20.4	3385	3036	166
		900	34.8	31.3	4807	4326	153
		1350	35.6	48.1	7149	6299	149
		1800	36.1	65.1	9200	7997	141
BXRC-27E4000-C-7x	80	585	33.2	19.4	3265	3090	168
		780	34.0	26.5	4278	3965	161
		1170	34.8	40.7	6249	5624	153
		1755	35.6	62.5	8989	7912	144
		2340	36.1	84.6	11531	9938	136
BXRC-27E4000-D-7x	80	525	27.7	14.6	2489	2311	171
		700	28.2	19.8	3237	2967	164
		1050	29.0	30.5	4673	4206	153
		1575	30.4	47.9	6675	5902	139
		2100	31.5	66.2	8497	7389	128
BXRC-27G4000-B-7x	90	450	33.2	14.9	2148	1930	144
		600	34.0	20.4	2817	2527	138
		900	34.8	31.3	4000	3600	128
		1350	35.6	48.1	5949	5242	124
		1800	36.1	65.1	7656	6655	118
BXRC-27G4000-C-7x	90	585	33.2	19.4	2717	2571	140
		780	34.0	26.5	3561	3300	134
		1170	34.8	40.7	5200	4680	128
		1755	35.6	62.5	7481	6585	120
		2340	36.1	84.6	9596	8271	113
BXRC-27G4000-D-7x	90	525	27.7	14.6	2072	1923	142
		700	28.2	19.8	2694	2469	136
		1050	29.0	30.5	3889	3500	128
		1575	30.4	47.9	5555	4912	116
		2100	31.5	66.2	7072	6149	107
BXRC-27H4000-B-7x	97	450	33.2	14.9	1871	1723	125
		600	34.0	20.4	2454	2212	120
		900	34.8	31.3	3484	3136	111
		1350	35.6	48.1	5182	4401	108
		1800	36.1	65.1	6668	5509	102
BXRC-27H4000-C-7x	97	585	33.2	19.4	2366	2239	122
		780	34.0	26.5	3101	2875	117
		1170	34.8	40.7	4529	4076	111
		1755	35.6	62.5	6516	5721	104
		2340	36.1	84.6	8358	7162	99
BXRC-27H4000-D-7x	97	525	27.7	14.6	1804	1675	124
		700	28.2	19.8	2346	2150	119
		1050	29.0	30.5	3387	3049	111
		1575	30.4	47.9	4838	4278	101
		2100	31.5	66.2	6159	5356	93

Notes for Table 4:

1. Alternate drive currents are provided for reference only and are not a guarantee of performance.
2. Bridgelux maintains a ± 7% tolerance on flux measurements.
3. Typical stabilized DC performance values are provided as reference only and are not a guarantee of performance.

Performance at Commonly Used Drive Currents

Table 4: Product Performance at Commonly Used Drive Currents (Continued)

Part Number	CRI	Drive Current ¹ (mA)	Typical V _f T _c = 25°C (V)	Typical Power T _c = 25°C (W)	Typical Flux ² T _c = 25°C (lm)	Typical DC Flux ³ T _c = 85°C (lm)	Typical Efficacy T _c = 25°C (lm/W)
BXRC-30E4000-B-7x	80	450	33.2	14.9	2685	2412	180
		600	34.0	20.4	3522	3159	173
		900	34.8	31.3	5000	4500	160
		1350	35.6	48.1	7437	6553	155
		1800	36.1	65.1	9570	8319	147
BXRC-30E4000-C-7x	80	585	33.2	19.4	3396	3214	175
		780	34.0	26.5	4451	4124	168
		1170	34.8	40.7	6500	5850	160
		1755	35.6	62.5	9351	8231	150
		2340	36.1	84.6	11995	10339	142
BXRC-30E4000-D-7x	80	525	27.7	14.6	2590	2404	178
		700	28.2	19.8	3367	3086	170
		1050	29.0	30.5	4861	4375	160
		1575	30.4	47.9	6944	6140	145
		2100	31.5	66.2	8839	7687	133
BXRC-30G4000-B-7x	90	450	33.2	14.9	2234	2008	149
		600	34.0	20.4	2931	2629	144
		900	34.8	31.3	4161	3745	133
		1350	35.6	48.1	6189	5453	129
		1800	36.1	65.1	7965	6923	122
BXRC-30G4000-C-7x	90	585	33.2	19.4	2827	2675	145
		780	34.0	26.5	3704	3433	140
		1170	34.8	40.7	5410	4869	133
		1755	35.6	62.5	7783	6850	124
		2340	36.1	84.6	9983	8604	118
BXRC-30G4000-D-7x	90	525	27.7	14.6	2155	2000	148
		700	28.2	19.8	2803	2568	142
		1050	29.0	30.5	4046	3641	133
		1575	30.4	47.9	5779	5110	121
		2100	31.5	66.2	7357	6397	111
BXRC-30G400C-B-73	90	450	33.2	14.9	2078	1868	139
		600	34.0	20.4	2726	2445	134
		900	34.8	31.3	3871	3484	124
		1350	35.6	48.1	5758	5073	120
		1800	36.1	65.1	7409	6440	114
BXRC-30G400C-D-73	90	525	27.7	14.6	2005	1861	138
		700	28.2	19.8	2607	2389	132
		1050	29.0	30.5	3764	3387	124
		1575	30.4	47.9	5376	4754	112
		2100	31.5	66.2	6843	5951	103
BXRC-30H4000-B-7x	97	450	33.2	14.9	1992	1834	133
		600	34.0	20.4	2613	2355	128
		900	34.8	31.3	3710	3339	118
		1350	35.6	48.1	5518	4686	115
		1800	36.1	65.1	7100	5866	109

Notes for Table 4:

1. Alternate drive currents are provided for reference only and are not a guarantee of performance.
2. Bridgelux maintains a ± 7% tolerance on flux measurements.
3. Typical stabilized DC performance values are provided as reference only and are not a guarantee of performance.

Performance at Commonly Used Drive Currents

Table 4: Product Performance at Commonly Used Drive Currents (Continued)

Part Number	CRI	Drive Current ¹ (mA)	Typical V _f T _c = 25°C (V)	Typical Power T _c = 25°C (W)	Typical Flux ² T _c = 25°C (lm)	Typical DC Flux ³ T _c = 85°C (lm)	Typical Efficacy T _c = 25°C (lm/W)
BXRC-30H4000-C-7x	97	585	33.2	19.4	2520	2385	130
		780	34.0	26.5	3302	3062	124
		1170	34.8	40.7	4823	4341	118
		1755	35.6	62.5	6938	6091	111
		2340	36.1	84.6	8900	7626	105
BXRC-30H4000-D-7x	97	525	27.7	14.6	1921	1783	132
		700	28.2	19.8	2498	2290	126
		1050	29.0	30.5	3607	3246	118
		1575	30.4	47.9	5152	4556	107
		2100	31.5	66.2	6558	5703	99
BXRC-30A4001-B-73	93	450	33.3	15.0	2018	1813	135
		600	33.9	20.4	2647	2374	130
		900	35.0	31.2	3758	3383	120
		1350	36.7	49.5	5590	4925	113
		1800	38.0	68.4	7193	6253	105
BXRC-30A4001-C-73	93	585	33.4	19.5	2553	2416	131
		780	34.0	26.5	3345	3100	126
		1170	35.0	40.6	4886	4397	120
		1755	36.8	64.5	7029	6187	109
		2340	38.1	89.3	9016	7771	101
BXRC-30A4001-D-73	93	525	27.7	14.6	1947	1807	134
		700	28.2	19.8	2531	2320	128
		1050	29.0	30.4	3654	3289	120
		1575	30.4	47.9	5219	4615	109
		2100	31.5	66.2	6644	5778	100
BXRC-35E4000-B-7x	80	450	33.2	14.9	2771	2490	185
		600	34.0	20.4	3635	3261	178
		900	34.8	31.3	5162	4645	165
		1350	35.6	48.1	7677	6764	160
		1800	36.1	65.1	9879	8587	152
BXRC-35E4000-C-7x	80	585	33.2	19.4	3506	3318	180
		780	34.0	26.5	4594	4257	173
		1170	34.8	40.7	6710	6039	165
		1755	35.6	62.5	9653	8496	154
		2340	36.1	84.6	12382	10672	146
BXRC-35E4000-D-7x	80	525	27.7	14.6	2673	2481	184
		700	28.2	19.8	3476	3186	176
		1050	29.0	30.5	5018	4516	165
		1575	30.4	47.9	7168	6338	150
		2100	31.5	66.2	9125	7935	138
BXRC-35G4000-B-7x	90	450	33.2	14.9	2304	2070	154
		600	34.0	20.4	3022	2710	148
		900	34.8	31.3	4291	3861	137
		1350	35.6	48.1	6381	5623	133
		1800	36.1	65.1	8212	7138	126

Notes for Table 4:

1. Alternate drive currents are provided for reference only and are not a guarantee of performance.
2. Bridgelux maintains a ± 7% tolerance on flux measurements.
3. Typical stabilized DC performance values are provided as reference only and are not a guarantee of performance.

Performance at Commonly Used Drive Currents

Table 4: Product Performance at Commonly Used Drive Currents (Continued)

Part Number	CRI	Drive Current ¹ (mA)	Typical V_f $T_c = 25^\circ\text{C}$ (V)	Typical Power $T_c = 25^\circ\text{C}$ (W)	Typical Flux ² $T_c = 25^\circ\text{C}$ (lm)	Typical DC Flux ³ $T_c = 85^\circ\text{C}$ (lm)	Typical Efficacy $T_c = 25^\circ\text{C}$ (lm/W)
BXRC-35G4000-C-7x	90	585	33.2	19.4	2914	2758	150
		780	34.0	26.5	3819	3539	144
		1170	34.8	40.7	5578	5020	137
		1755	35.6	62.5	8024	7062	128
		2340	36.1	84.6	10293	8871	122
BXRC-35G4000-D-7x	90	525	27.7	14.6	2222	2063	153
		700	28.2	19.8	2889	2648	146
		1050	29.0	30.5	4171	3754	137
		1575	30.4	47.9	5958	5269	124
		2100	31.5	66.2	7585	6596	115
BXRC-35A4001-B-73	80	450	33.2	14.9	2169	1949	145
		600	34.0	20.4	2846	2552	139
		900	34.8	31.3	4040	3636	129
		1350	35.6	48.1	6009	5295	125
		1800	36.1	65.1	7733	6722	119
BXRC-35A4001-C-73	80	585	33.2	19.4	2744	2597	141
		780	34.0	26.5	3596	3333	136
		1170	34.8	40.7	5252	4727	129
		1755	35.6	62.5	7556	6651	121
		2340	36.1	84.6	9692	8354	115
BXRC-35A4001-D-73	80	525	27.7	14.6	2092	1942	144
		700	28.2	19.8	2721	2494	138
		1050	29.0	30.5	3928	3535	129
		1575	30.4	47.9	5611	4961	117
		2100	31.5	66.2	7142	6211	108
BXRC-40E4000-B-7x	80	450	33.2	14.9	2789	2506	187
		600	34.0	20.4	3658	3281	179
		900	34.8	31.3	5194	4674	166
		1350	35.6	48.1	7725	6806	161
		1800	36.1	65.1	9940	8641	153
BXRC-40E4000-C-7x	80	585	33.2	19.4	3528	3339	182
		780	34.0	26.5	4623	4284	174
		1170	34.8	40.7	6752	6077	166
		1755	35.6	62.5	9713	8549	155
		2340	36.1	84.6	12459	10739	147
BXRC-40E4000-D-7x	80	525	27.7	14.6	2690	2497	185
		700	28.2	19.8	3498	3205	177
		1050	29.0	30.5	5050	4545	166
		1575	30.4	47.9	7213	6378	150
		2100	31.5	66.2	9182	7984	139
BXRC-40G4000-B-7x	90	450	33.2	14.9	2390	2148	160
		600	34.0	20.4	3135	2812	154
		900	34.8	31.3	4452	4007	142
		1350	35.6	48.1	6621	5834	138
		1800	36.1	65.1	8520	7407	131

Notes for Table 4:

1. Alternate drive currents are provided for reference only and are not a guarantee of performance.
2. Bridgelux maintains a $\pm 7\%$ tolerance on flux measurements.
3. Typical stabilized DC performance values are provided as reference only and are not a guarantee of performance.

Performance at Commonly Used Drive Currents

Table 4: Product Performance at Commonly Used Drive Currents (Continued)

Part Number	CRI	Drive Current ¹ (mA)	Typical V _f T _c = 25°C (V)	Typical Power T _c = 25°C (W)	Typical Flux ² T _c = 25°C (lm)	Typical DC Flux ³ T _c = 85°C (lm)	Typical Efficacy T _c = 25°C (lm/W)
BXRC-40G4000-C-7x	90	585	33.2	19.4	3024	2862	156
		780	34.0	26.5	3962	3672	149
		1170	34.8	40.7	5787	5209	142
		1755	35.6	62.5	8326	7328	133
		2340	36.1	84.6	10680	9205	126
BXRC-40G4000-D-7x	90	525	27.7	14.6	2306	2140	158
		700	28.2	19.8	2998	2748	152
		1050	29.0	30.5	4328	3895	142
		1575	30.4	47.9	6182	5467	129
		2100	31.5	66.2	7870	6844	119
BXRC-40H4000-B-7x	97	450	33.2	14.9	2052	1843	137
		600	34.0	20.4	2691	2414	132
		900	34.8	31.3	3821	3439	122
		1350	35.6	48.1	5683	5007	118
		1800	36.1	65.1	7313	6357	112
BXRC-40H4000-C-7x	97	585	33.2	19.4	2595	2456	134
		780	34.0	26.5	3401	3152	128
		1170	34.8	40.7	4967	4471	122
		1755	35.6	62.5	7146	6290	114
		2340	36.1	84.6	9166	7900	108
BXRC-40H4000-D-7x	97	525	27.7	14.6	1979	1837	136
		700	28.2	19.8	2573	2358	130
		1050	29.0	30.5	3715	3343	122
		1575	30.4	47.9	5306	4692	111
		2100	31.5	66.2	6755	5874	102
BXRC-40A4001-B-73	80	450	33.2	14.9	2321	2085	155
		600	34.0	20.4	3044	2730	149
		900	34.8	31.3	4322	3890	138
		1350	35.6	48.1	6428	5664	134
		1800	36.1	65.1	8272	7191	127
BXRC-40A4001-C-73	80	585	33.2	19.4	2936	2778	151
		780	34.0	26.5	3847	3565	145
		1170	34.8	40.7	5619	5057	138
		1755	35.6	62.5	8083	7115	129
		2340	36.1	84.6	10368	8937	123
BXRC-40A4001-D-73	80	525	27.7	14.6	2238	2078	154
		700	28.2	19.8	2911	2667	147
		1050	29.0	30.5	4202	3782	138
		1575	30.4	47.9	6002	5307	125
		2100	31.5	66.2	7641	6644	115
BXRC-50C4001-B-7x	70	450	33.2	14.9	3066	2755	205
		600	34.0	20.4	4022	3607	197
		900	34.8	31.3	5710	5139	182
		1350	35.6	48.1	8492	7483	177
		1800	36.1	65.1	10928	9500	168

Notes for Table 4:

1. Alternate drive currents are provided for reference only and are not a guarantee of performance.
2. Bridgelux maintains a ± 7% tolerance on flux measurements.
3. Typical stabilized DC performance values are provided as reference only and are not a guarantee of performance.

Performance at Commonly Used Drive Currents

Table 4: Product Performance at Commonly Used Drive Currents (Continued)

Part Number	CRI	Drive Current ¹ (mA)	Typical V_f $T_c = 25^\circ\text{C}$ (V)	Typical Power $T_c = 25^\circ\text{C}$ (W)	Typical Flux ² $T_c = 25^\circ\text{C}$ (lm)	Typical DC Flux ³ $T_c = 85^\circ\text{C}$ (lm)	Typical Efficacy $T_c = 25^\circ\text{C}$ (lm/W)
BXRC-50C4001-C-7x	70	585	33.2	19.4	3878	3670	200
		780	34.0	26.5	5082	4710	192
		1170	34.8	40.7	7423	6681	182
		1755	35.6	62.5	10679	9399	171
		2340	36.1	84.6	13698	11806	162
BXRC-50C4001-D-7x	70	525	27.7	14.6	2957	2745	203
		700	28.2	19.8	3845	3524	195
		1050	29.0	30.5	5551	4996	182
		1575	30.4	47.9	7929	7012	165
		2100	31.5	66.2	10094	8778	152
BXRC-50E4001-B-7x	80	450	33.2	14.9	2875	2584	192
		600	34.0	20.4	3772	3383	185
		900	34.8	31.3	5355	4820	171
		1350	35.6	48.1	7965	7018	166
		1800	36.1	65.1	10249	8909	158
BXRC-50E4001-C-7x	80	585	33.2	19.4	3637	3442	187
		780	34.0	26.5	4766	4417	180
		1170	34.8	40.7	6962	6265	171
		1755	35.6	62.5	10015	8815	160
		2340	36.1	84.6	12846	11072	152
BXRC-50E4001-D-7x	80	525	27.7	14.6	2773	2574	190
		700	28.2	19.8	3606	3305	183
		1050	29.0	30.5	5206	4686	171
		1575	30.4	47.9	7437	6576	155
		2100	31.5	66.2	9467	8232	143
BXRC-50G4001-B-7x	90	450	33.2	14.9	2442	2194	163
		600	34.0	20.4	3204	2873	157
		900	34.8	31.3	4549	4094	145
		1350	35.6	48.1	6765	5961	141
		1800	36.1	65.1	8706	7568	134
BXRC-50G4001-C-7x	90	585	33.2	19.4	3090	2924	159
		780	34.0	26.5	4049	3752	153
		1170	34.8	40.7	5913	5322	145
		1755	35.6	62.5	8507	7487	136
		2340	36.1	84.6	10912	9405	129
BXRC-50G4001-D-7x	90	525	27.7	14.6	2356	2187	162
		700	28.2	19.8	3063	2807	155
		1050	29.0	30.5	4422	3980	145
		1575	30.4	47.9	6317	5586	132
		2100	31.5	66.2	8041	6992	121
BXRC-56G4000-B-74	90	450	33.2	14.9	2543	2361	170
		600	34.0	20.4	3307	3031	162
		900	34.8	31.3	4774	4297	152
		1350	35.6	48.1	6820	6030	142
		1800	36.1	65.1	8681	7549	133

Notes for Table 4:

1. Alternate drive currents are provided for reference only and are not a guarantee of performance.
2. Bridgelux maintains a $\pm 7\%$ tolerance on flux measurements.
3. Typical stabilized DC performance values are provided as reference only and are not a guarantee of performance.

Performance at Commonly Used Drive Currents

Table 4: Product Performance at Commonly Used Drive Currents (Continued)

Part Number	CRI	Drive Current ¹ (mA)	Typical V _f T _c = 25°C (V)	Typical Power T _c = 25°C (W)	Typical Flux ² T _c = 25°C (lm)	Typical DC Flux ³ T _c = 85°C (lm)	Typical Efficacy T _c = 25°C (lm/W)
BXRC-56G4000-C-74	90	585	33.2	19.4	3306	3069	170
		780	34.0	26.5	4299	3940	162
		1170	34.8	40.7	6207	5586	152
		1755	35.6	62.5	8865	7839	142
		2340	36.1	84.6	11286	9814	133
BXRC-56G400x-D-74	90	525	27.7	14.6	2473	2295	170
		700	28.2	19.8	3215	2947	163
		1050	29.0	30.5	4642	4178	152
		1575	30.4	47.9	6630	5863	138
		2100	31.5	66.2	8440	7340	127
BXRC-56H4000-D-74	97	525	27.7	14.6	2139	1985	147
		700	28.2	19.8	2781	2548	141
		1050	29.0	30.5	4015	3613	132
		1575	30.4	47.9	5734	5071	120
		2100	31.5	66.2	7300	6348	110
BXRC-57C4001-B-7x	70	450	33.2	14.9	2962	2661	198
		600	34.0	20.4	3885	3485	190
		900	34.8	31.3	5516	4965	176
		1350	35.6	48.1	7205	7229	171
		1800	36.1	65.1	10558	9178	162
BXRC-57C4001-C-7x	70	585	33.2	19.4	3747	3546	193
		780	34.0	26.5	4910	4550	185
		1170	34.8	40.7	7171	6454	176
		1755	35.6	62.5	10317	9080	165
		2340	36.1	84.6	13233	11406	156
BXRC-57C4001-D-7x	70	525	27.7	14.6	2857	2652	196
		700	28.2	19.8	3715	3405	188
		1050	29.0	30.5	5363	4827	176
		1575	30.4	47.9	7661	6774	160
		2100	31.5	66.2	9752	8480	147
BXRC-57E4001-B-7x	80	450	33.2	14.9	2842	2554	190
		600	34.0	20.4	3728	3344	183
		900	34.8	31.3	5293	4764	169
		1350	35.6	48.1	7872	6936	164
		1800	36.1	65.1	10130	8806	156
BXRC-57E4001-C-7x	80	585	33.2	19.4	3595	3402	185
		780	34.0	26.5	4711	4366	178
		1170	34.8	40.7	6881	6193	169
		1755	35.6	62.5	9899	8713	158
		2340	36.1	84.6	12698	10944	150
BXRC-57E4001-D-7x	80	525	27.7	14.6	2741	2544	188
		700	28.2	19.8	3565	3267	180
		1050	29.0	30.5	5146	4631	169
		1575	30.4	47.9	7350	6500	153
		2100	31.5	66.2	9357	8137	141

Notes for Table 4:

1. Alternate drive currents are provided for reference only and are not a guarantee of performance.
2. Bridgelux maintains a ± 7% tolerance on flux measurements.
3. Typical stabilized DC performance values are provided as reference only and are not a guarantee of performance.

Performance at Commonly Used Drive Currents

Table 4: Product Performance at Commonly Used Drive Currents (Continued)

Part Number	CRI	Drive Current ¹ (mA)	Typical V _f T _c = 25°C (V)	Typical Power T _c = 25°C (W)	Typical Flux ² T _c = 25°C (lm)	Typical DC Flux ³ T _c = 85°C (lm)	Typical Efficacy T _c = 25°C (lm/W)
BXRC-65C4001-B-7x	70	450	33.2	14.9	3014	2708	202
		600	34.0	20.4	3953	3546	194
		900	34.8	31.3	5613	5052	179
		1350	35.6	48.1	8348	7356	174
		1800	36.1	65.1	10743	9339	165
BXRC-65C4001-C-7x	70	585	33.2	19.4	3813	3608	196
		780	34.0	26.5	4996	4630	188
		1170	34.8	40.7	7297	6567	179
		1755	35.6	62.5	10498	9240	168
		2340	36.1	84.6	13466	11606	159
BXRC-65C4001-D-7x	70	525	27.7	14.6	2907	2698	200
		700	28.2	19.8	3780	3464	191
		1050	29.0	30.5	5457	4912	179
		1575	30.4	47.9	7795	6893	163
		2100	31.5	66.2	9923	8629	150
BXRC-65E4001-B-7x	80	450	33.2	14.9	2892	2599	194
		600	34.0	20.4	3794	3403	186
		900	34.8	31.3	5387	4848	172
		1350	35.6	48.1	8012	7059	167
		1800	36.1	65.1	10310	8962	158
BXRC-65E4001-C-7x	80	585	33.2	19.4	3659	3463	188
		780	34.0	26.5	4795	4443	181
		1170	34.8	40.7	7003	6303	172
		1755	35.6	62.5	10075	8867	161
		2340	36.1	84.6	12923	11138	153
BXRC-65E4001-D-7x	80	525	27.7	14.6	2790	2590	192
		700	28.2	19.8	3628	3325	184
		1050	29.0	30.5	5237	4714	172
		1575	30.4	47.9	7481	6615	156
		2100	31.5	66.2	9523	8281	144

Notes for Table 4:

1. Alternate drive currents are provided for reference only and are not a guarantee of performance.
2. Bridgelux maintains a ± 7% tolerance on flux measurements.
3. Typical stabilized DC performance values are provided as reference only and are not a guarantee of performance.

Electrical Characteristics

Table 5: Electrical Characteristics

Part Number	Drive Current (mA)	Forward Voltage Pulsed, $T_c = 25^\circ\text{C}$ (V) ^{1, 2, 3, 8}			Typical Coefficient of Forward Voltage ⁴ $\Delta V_f / \Delta T_c$ (mV/ $^\circ\text{C}$)	Typical Thermal Resistance Junction to Case ^{5,6} R_{j-c} ($^\circ\text{C}/\text{W}$)	Driver Selection Voltages ⁷ (V)	
		Minimum	Typical	Maximum			V_f Min. Hot $T_c = 105^\circ\text{C}$ (V)	V_f Max. Cold $T_c = -40^\circ\text{C}$ (V)
BXRC-xxx400x-B-7x	900	32.2	34.8	37.4	-14.9	0.15	31.0	38.4
	1800	33.4	36.1	38.8	-14.9	0.19	32.2	39.8
BXRC-xxx400x-C-7x	1170	32.2	34.8	37.4	-14.9	0.11	31.0	38.4
	2340	33.4	36.1	38.8	-14.9	0.13	32.2	39.8
BXRC-xxx400x-D-7x	1050	26.8	29.0	31.2	-12.2	0.16	25.8	32.0
	2100	29.2	31.5	33.9	-12.2	0.19	28.2	34.7

Notes for Table 5:

- Parts are tested in pulsed conditions. $T_c = 25^\circ\text{C}$. Pulse width is 10ms.
- Voltage minimum and maximum are provided for reference only and are not a guarantee of performance.
- Bridgelux maintains a tester tolerance of $\pm 0.10\text{V}$ on forward voltage measurements.
- Typical coefficient of forward voltage tolerance is $\pm 0.1\text{mV}$ for nominal current.
- Thermal resistance values are based from test data of a 3000K 80 CRI product.
- Thermal resistance value was calculated using total electrical input power; optical power was not subtracted from input power. The thermal interface material used during testing is not included in the thermal resistance value.
- V_f min hot and max cold values are provided as reference only and are not guaranteed by test. These values are provided to aid in driver design and selection over the operating range of the product.
- This product has been designed and manufactured per IEC 62031:2014. This product has passed dielectric withstand voltage testing at 1160 V. The working voltage designated for the insulation is 80V d.c. The maximum allowable voltage across the array must be determined in the end product application.

Eye Safety

Table 6: Eye Safety Risk Group (RG) Classifications

Part Number	Drive Current ⁵ (mA)	CCT ¹⁻⁵			
		2700K/3000K	4000K ²	5000K ³	6500K ⁴
BXRC-xxx400x-B-7x	900	RG1	RG1	RG1	RG1
	1350	RG1	RG1	RG1	RG2
	1800	RG1	RG1	RG2	RG2
BXRC-xxx400x-C-7x	1170	RG1	RG1	RG1	RG1
	1755	RG1	RG1	RG2	RG2
	2340	RG1	RG1	RG2	RG2
BXRC-xxx400x-D-7x	1050	RG1	RG1	RG1	RG1
	1575	RG1	RG1	RG1	RG2
	2100	RG1	RG1	RG2	RG2

Notes for Table 6:

1. Eye safety classification for the use of Bridgelux Vero Series LED arrays is in accordance with specification IEC/TR 62778: Application of IEC 62471 for the assessment of blue light hazard to light sources and luminaires.
2. For products classified as RG2 at 4000K, $E_{thr} = 1847.5$ lx.
3. For products classified as RG2 at 5000K, $E_{thr} = 1315.8$ lx.
4. For products classified as RG2 at 6500K, $E_{thr} = 1124.5$ lx.
5. Please contact your Bridgelux sales representative for E_{thr} values at specific drive currents and CCTs not listed.

Absolute Maximum Ratings

Table 7: Maximum Ratings

Parameter	Maximum Rating		
LED Junction Temperature (T_j)	125°C		
Storage Temperature	-40°C to +105°C		
Operating Case Temperature ¹ (T_c)	105°C		
Soldering Temperature ²	300°C or lower for a maximum of 6 seconds		
	BXRC-xxx400x-B-7x	BXRC-xxx400x-C-7x	BXRC-xxx400x-D-7x
Maximum Drive Current ³	1800mA	2340mA	2100mA
Maximum Peak Pulsed Drive Current ⁴	2570mA	3340mA	3000mA
Maximum Reverse Voltage ⁵	-60V	-60V	-50V

Notes for Table 7:

1. For IEC 62717 requirement, please consult your Bridgelux sales representative.
2. Refer to Bridgelux Application Note AN31: Assembly Considerations for Bridgelux Vero LED Arrays.
3. Arrays may be driven at higher currents however lumen maintenance may be reduced.
4. Bridgelux recommends a maximum duty cycle of 10% and pulse width of 20 ms when operating LED Arrays at maximum peak pulsed current specified. Maximum peak pulsed currents indicate values where LED Arrays can be driven without catastrophic failures.
5. Light emitting diodes are not designed to be driven in reverse voltage and will not produce light under this condition. Maximum rating provided for reference only.

Performance Curves

Figure 1: Vero 18B Drive Current vs. Voltage

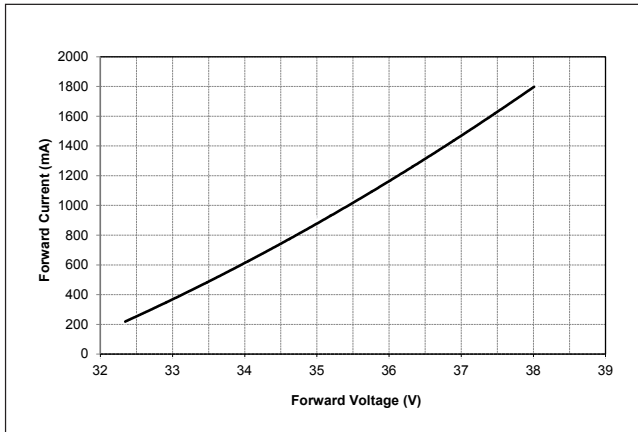

Figure 2: Vero 18C Drive Current vs. Voltage

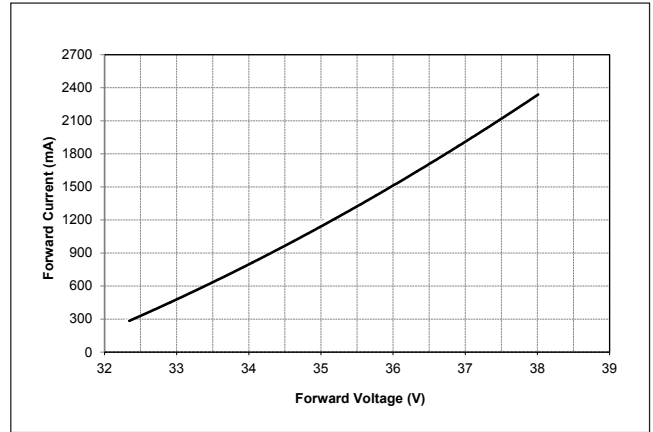

Figure 3: Vero 18D Drive Current vs. Voltage

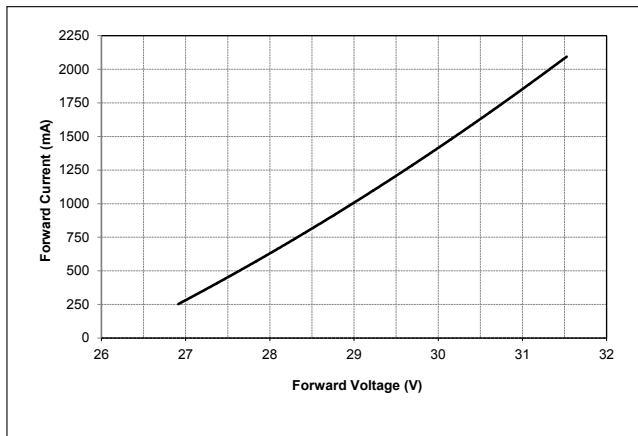

Figure 4: Vero 18B Typical Relative Flux vs. Current

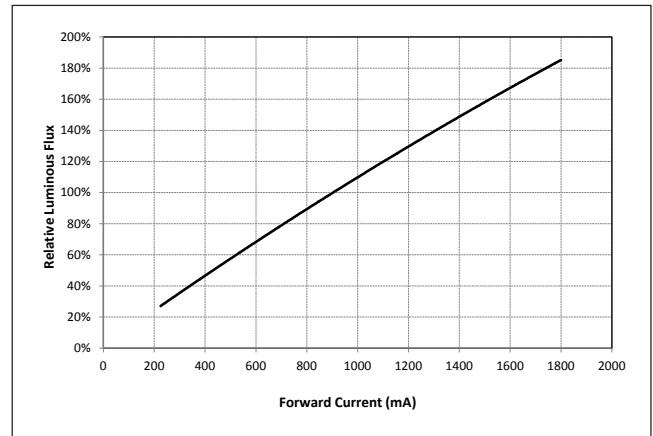

Figure 5: Vero 18C Typical Relative Flux vs. Current

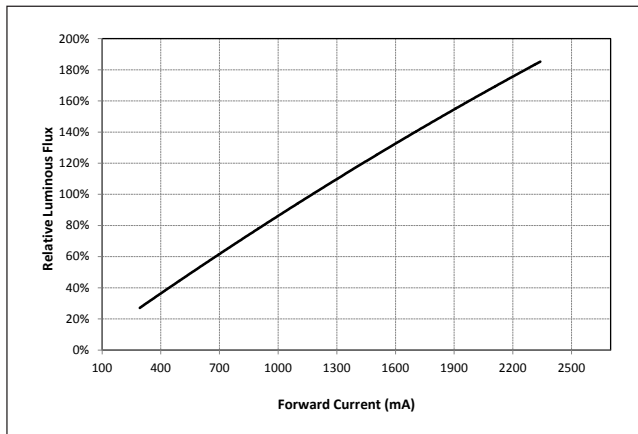
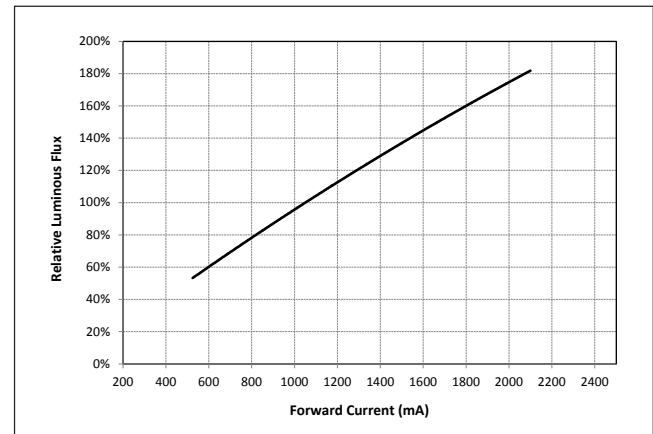

Figure 6: Vero 18D Typical Relative Flux vs. Current



Notes for Figures 1-6:

1. Bridgelux does not recommend driving high power LEDs at low currents. Doing so may produce unpredictable results. Pulse width modulation (PWM) is recommended for dimming effects.
2. Products tested under pulsed condition (10ms pulse width) at nominal test current where T_j (junction temperature) = T_c (case temperature) = 25°C.

Performance Curves

Figure 7: Typical DC Flux vs. Case Temperature

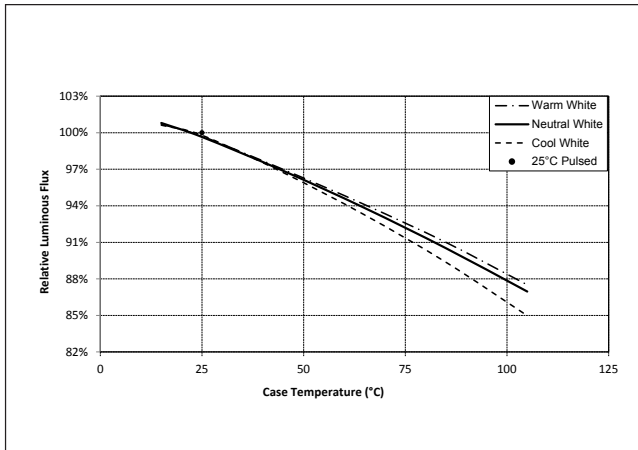

Figure 8: Typical DC ccy Shift vs. Case Temperature

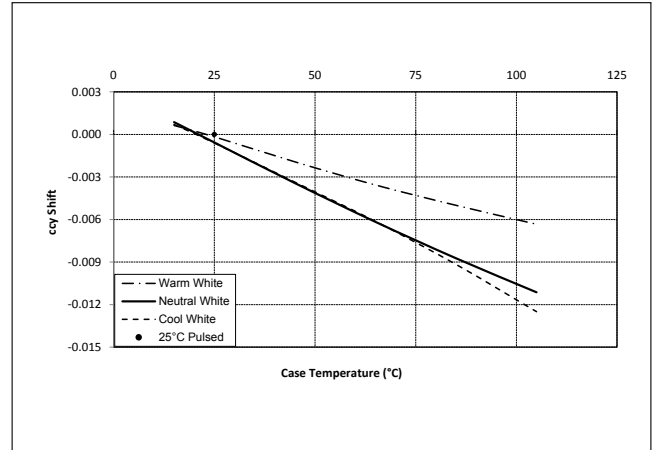
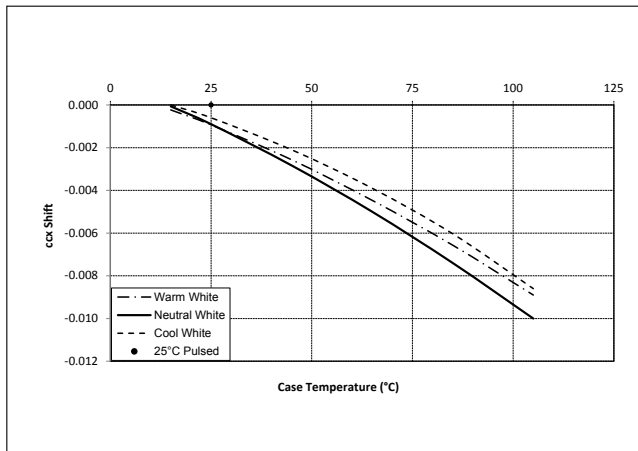

Figure 9: Typical DC ccx Shift vs. Case Temperature



Notes for Figures 7-9:

1. Characteristics shown for warm white based on 3000K and 80 CRI.
2. Characteristics shown for neutral white based on 4000K and 80 CRI.
3. Characteristics shown for cool white based on 5000K and 70 CRI.
4. For other color SKUs, the shift in color will vary. Please contact your Bridgelux Sales Representative for more information.

Performance Curves

Figure 10: 1750K Color Shift vs. Case Temperature¹

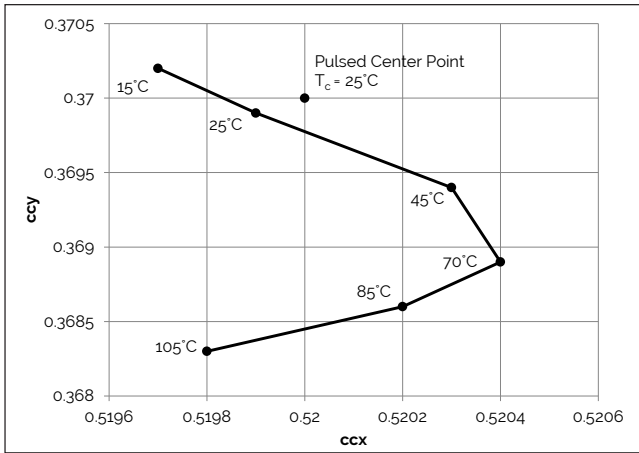

Figure 11: 2000K, 65 CRI Color Shift vs. Case Temperature

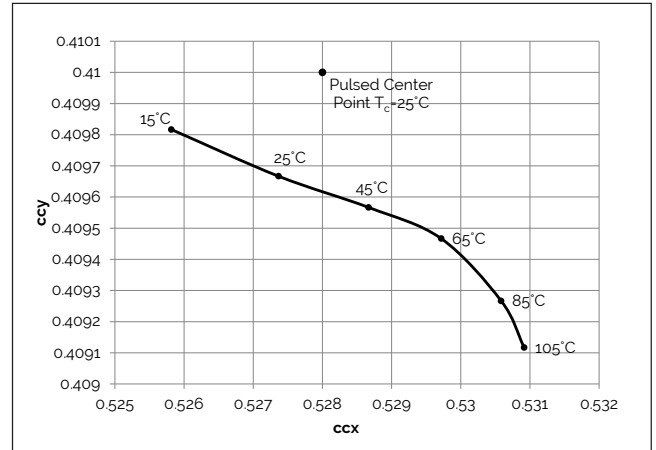

Figure 12: 2500K Color Shift vs. Case Temperature¹

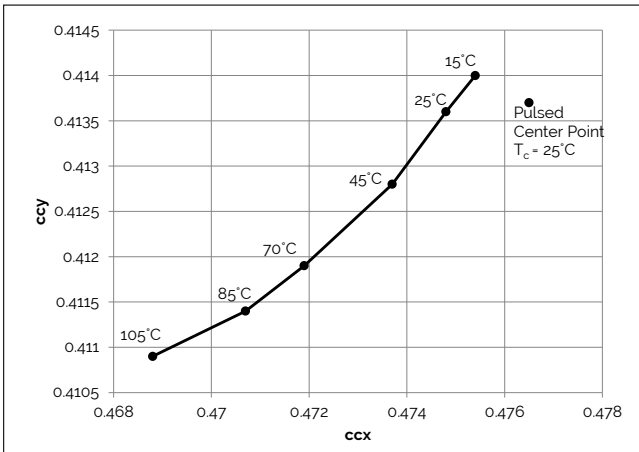

Figure 13: 3000K, 90 CRI Color Shift vs. Case Temperature^{1,3}

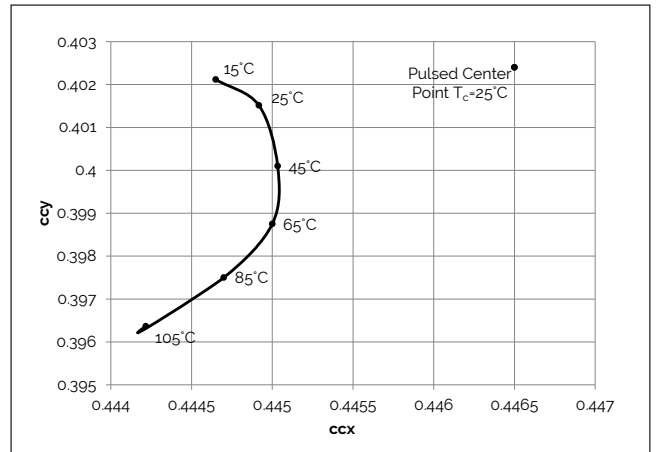

Figure 14: 2700K, 97 CRI Color Shift vs. Case Temperature¹

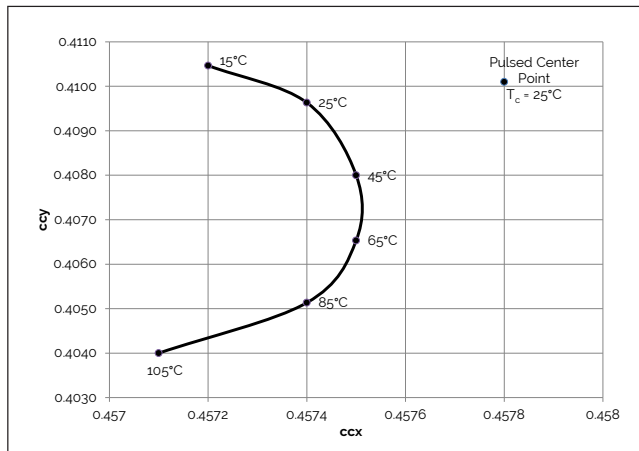
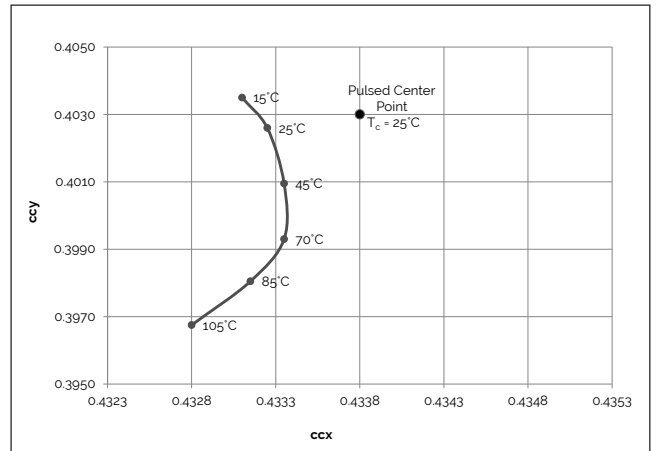

Figure 15: 3000K, 97 CRI Color Shift vs. Case Temperature¹



Note for Figures 10-15:

1. Measurements made under DC test conditions at the nominal drive current.
2. Typical color shift is shown with a tolerance of ± 0.002 .
3. Characteristics shown for Decor Series Showcase products, BXRC-30G400C-x-73

Performance Curves

Figure 16: 5600K Color Shift vs. Case Temperature^{1,3}

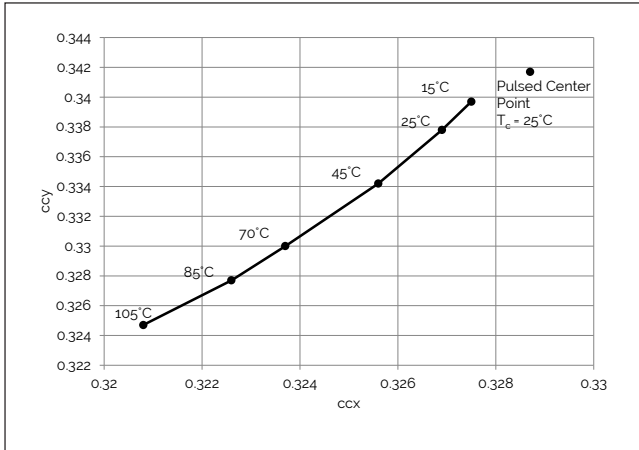

Figure 17: 3000K Class A Color Shift vs. Case Temperature¹

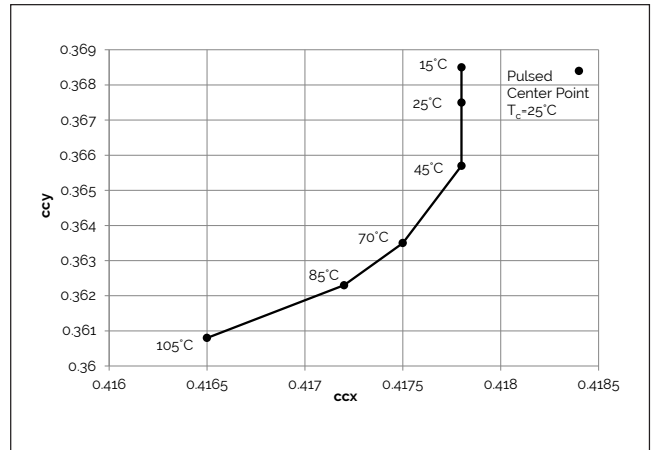

Figure 18: 3500K Class A Color Shift vs. Case Temperature¹

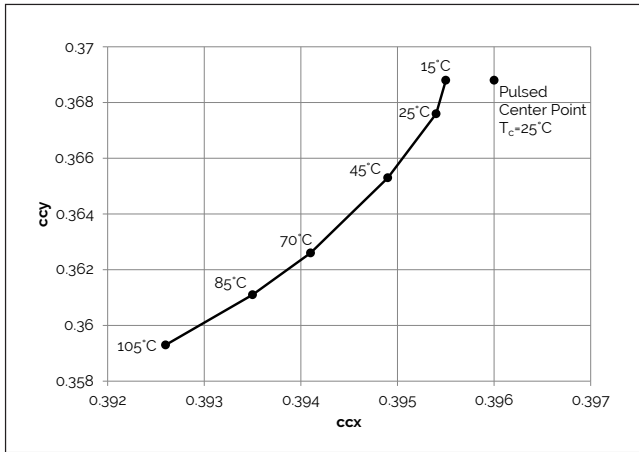
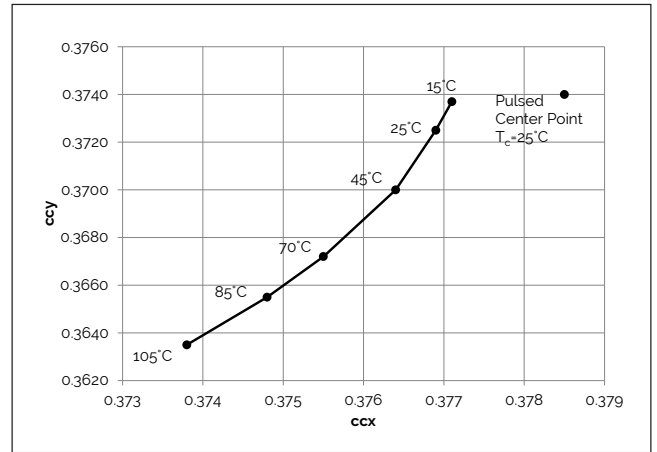

Figure 19: 4000K Class A Color Shift vs. Case Temperature¹



Note for Figures 16-19:

1. Measurements made under DC test conditions at the nominal drive current.
2. Typical color shift is shown with a tolerance of ± 0.002 .
3. Color shift shown for product hot targeted at $T_c = 85^\circ\text{C}$

Typical Radiation Pattern

Figure 20: Typical Spatial Radiation Pattern

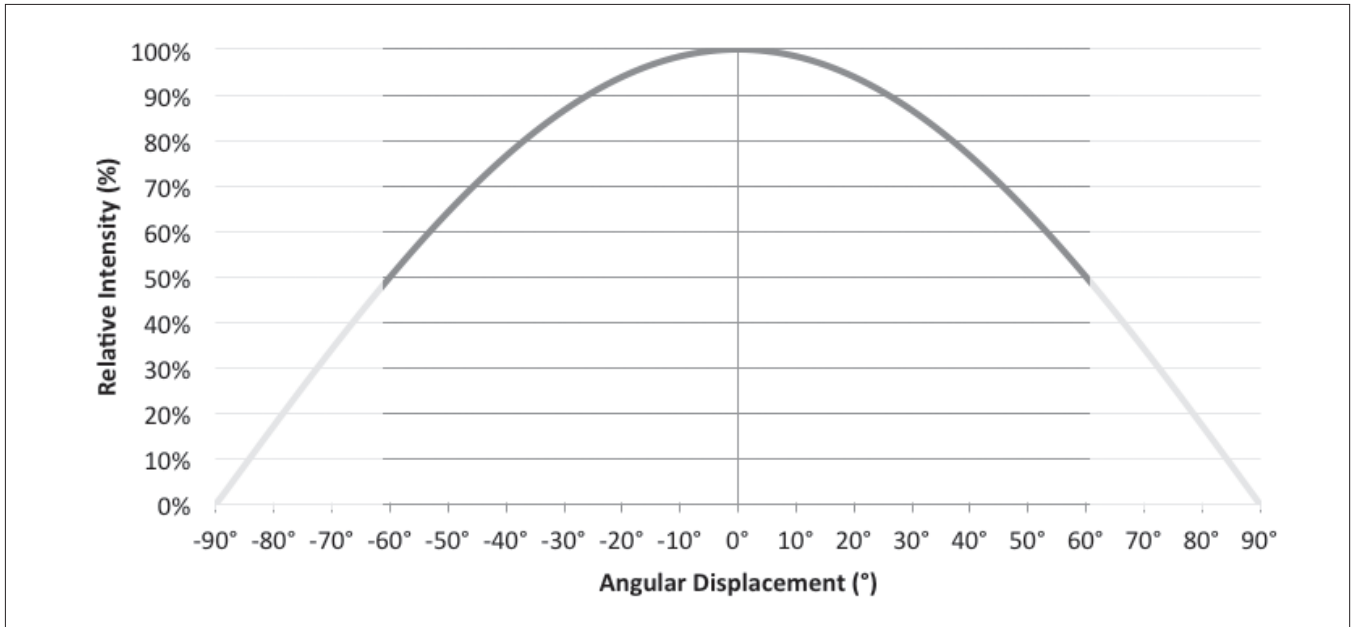

Note for Figure 20:

1. Typical viewing angle is 120°.
2. The viewing angle is defined as the off axis angle from the centerline where intensity is ½ of the peak value.

Figure 21: Typical Polar Radiation Pattern

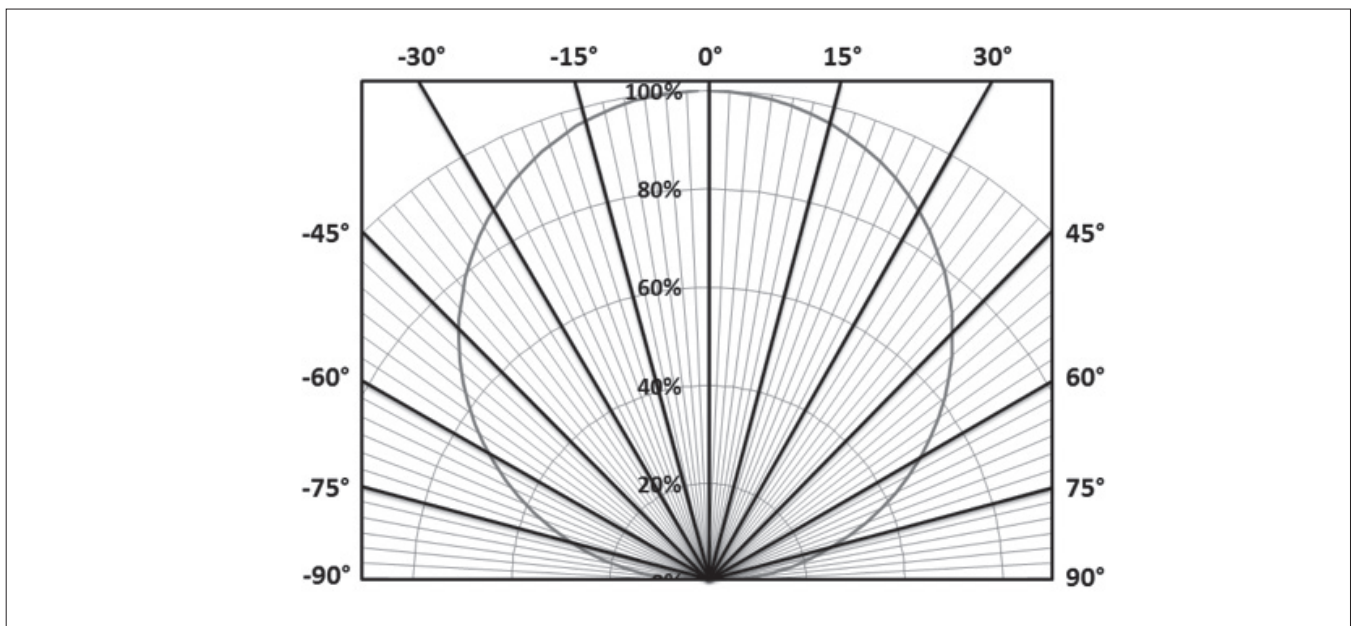

Typical Color Spectrum

Figure 22: Typical Color Spectrum

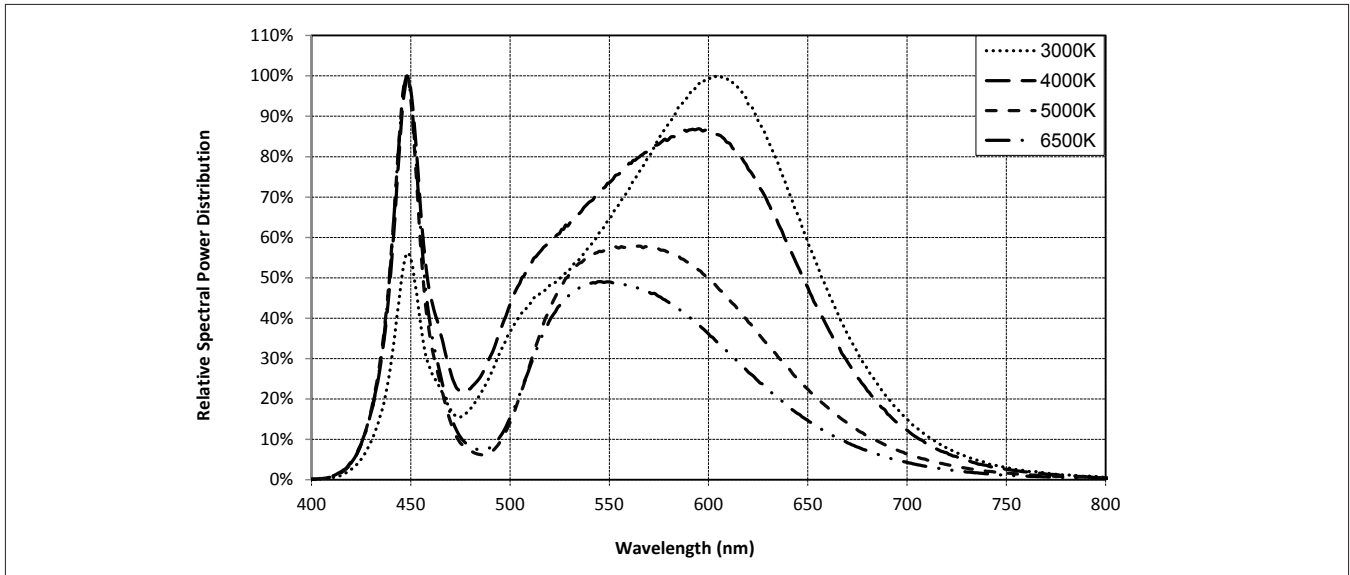

Note for Figure 22:

1. Color spectra measured at nominal current for $T_j = T_c = 25^\circ\text{C}$.
2. Color spectra shown is 3000K and 80 CRI.
3. Color spectra shown is 4000K and 80 CRI.
4. Color spectra shown is 5000K and 70 CRI.
4. Color spectra shown is 6500K and 70 CRI.

Figure 23: Typical Color Spectrum for Vero 18 with Décor Series

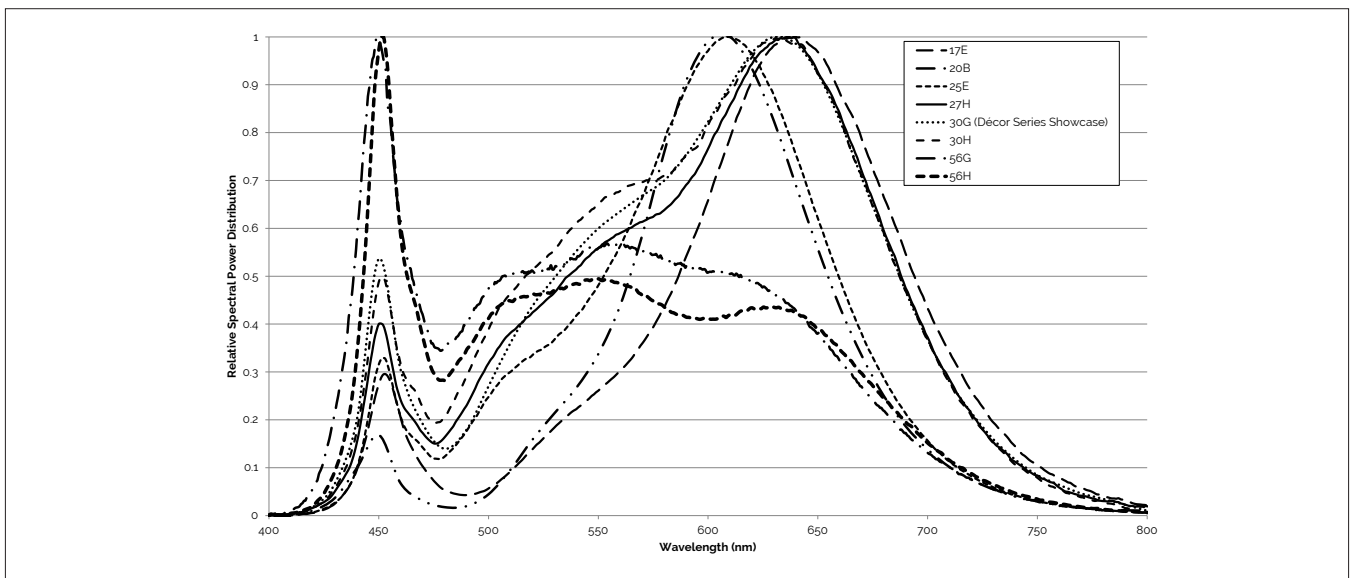

Note for Figure 23:

1. Color spectra measured at nominal current for $T_j = T_c = 25^\circ\text{C}$.

Color Binning Information

Figure 25: Warm and Neutral White Test Bins in xy Color Space

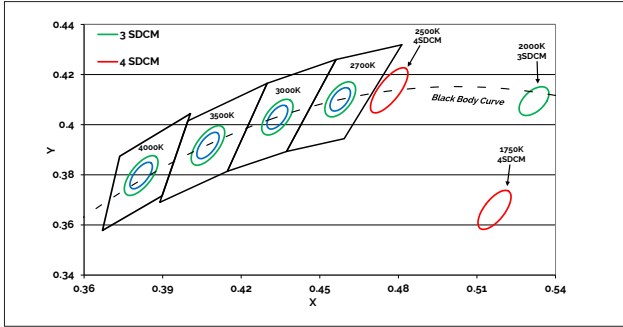

Note: Pulsed Test Conditions, $T_c = 25^\circ\text{C}$

Table 8: Warm and Neutral White xy Bin Coordinates and Associated Typical CCT

Bin Code	1750K	2000K	2500K	2700K	3000K ¹	3500K ¹	4000K ²
ANSI Bin (for reference only)	-	-	-	(2580K - 2870K)	(2870K - 3220K)	(3220K - 3710K)	(3710K - 4260K)
73 (3 SDCM)	-	-	-	(2651K - 2794K)	(2968K - 3136K)	(3369K - 3586K)	(3851K - 4130K)
72 (2 SDCM)	-	-	-	(2674K - 2769K)	(2995K - 3107K)	(3404K - 3548K)	(3895K - 4081K)
Center Point (x,y)	(0.5167, 0.336)	(0.5280, 0.4100)	(0.4765, 0.4137)	(0.4578, 0.4101)	(0.4338, 0.403) (0.4465, 0.4024) ²	(0.4073, 0.3917)	(0.3818, 0.3797)

Note for Table 8:

- Color Binning information excludes Decor Series Class A products. Please contact your Bridgelux Sales Representative for more information.
- Center Point for Decor Series Showcase.

Figure 26: Cool White Test Bins in xy Color Space

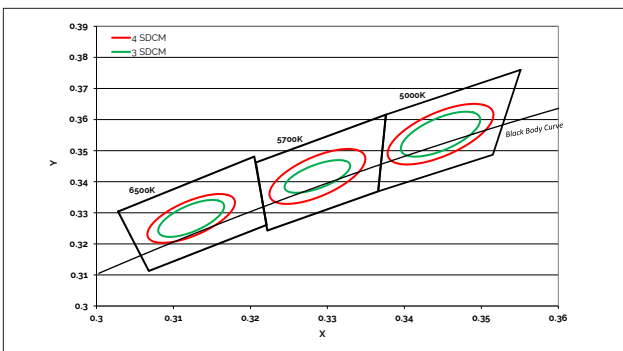

Note: Pulsed Test Conditions, $T_c = 25^\circ\text{C}$

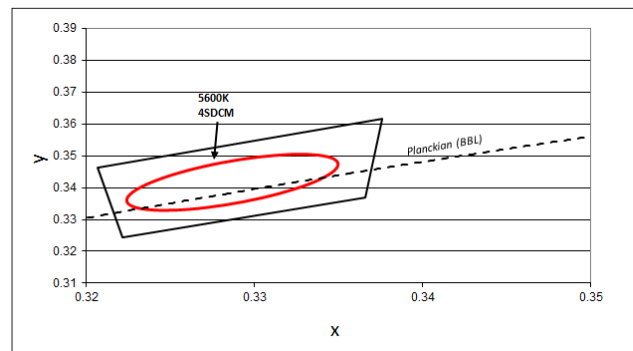

Note: Pulsed Test Conditions, $T_c = 25^\circ\text{C}$

Table 9: Cool White xy Bin Coordinates and Associated Typical CCT (product is hot targeted to $T_c = 85^\circ\text{C}$)

Bin Code	5000K	5600K	5700K	6500K
ANSI Bin (for reference only)	(4745K - 5311K)	(5310K - 6020K)	(5312K - 6022K)	(6022K - 7042K)
74 (4 SDCM)	(4801K - 5282K)	(5475K - 5830K)	(5481K - 5829K)	(6270K - 6765K)
73 (3 SDCM)	(4835K - 5215K)	(5490K - 5820K)	(5490K - 5820K)	(6250K - 6745K)
Center Point (x,y)	(0.3447, 0.3553)	(0.3293, 0.3423)	(0.3287, 0.3417)	(0.3123, 0.3282)

Note for Table 9:

- Select configurations with a CCT of 5600K are available with center point targets at $T_c = 85^\circ\text{C}$ or $T_c = 25^\circ\text{C}$.

Packaging and Labeling

Figure 27: Drawing for Vero 18 Packaging Tray

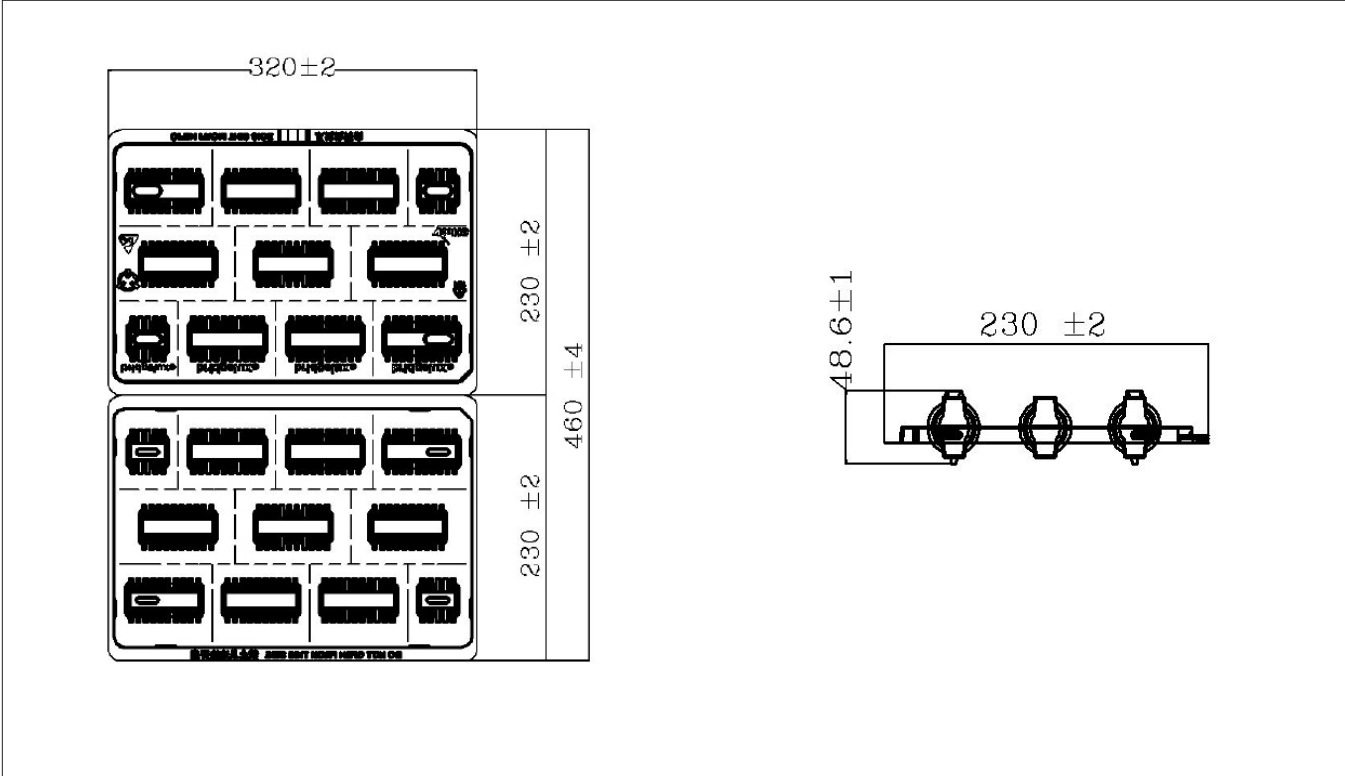

- Notes for Figure 27:
1. Dimensions are in millimeters.
 2. Drawings are not to scale.

Packaging and Labeling

Figure 28: Vero Series Packaging and Labeling

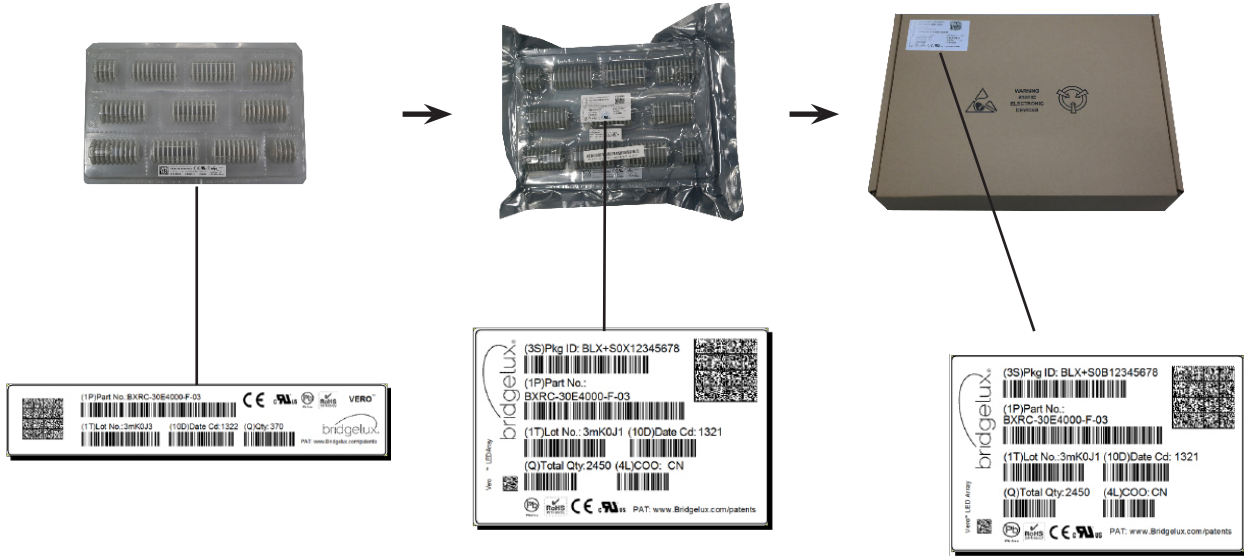

Notes for Figure 28:

1. Each tray holds 100 COBs.
2. Each tray is vacuum sealed in an anti-static bag and placed in its own box.
3. Each tray, bag and box is to be labeled as shown above.

Figure 29: Gen. 7 Product Labeling

Bridgelux COB arrays have laser markings on the back side of the substrate to help with product identification. In addition to the product identification markings, Bridgelux COB arrays also contain markings for internal Bridgelux manufacturing use only. The image below shows which markings are for customer use and which ones are for Bridgelux internal use only. The Bridgelux internal manufacturing markings are subject to change without notice, however these will not impact the form, function or performance of the COB array.



Customer Use- 2D Barcode
Scannable barcode provides product part number and other Bridgelux internal production information.

Customer Use- Product part number

30E4000C 73 2F

Customer Use- V_f Bin Code
included to enable greater luminaire design flexibility. Refer to ANG2 for bin code definitions.

Design Resources

Application Notes

Bridgelux has developed a comprehensive set of application notes and design resources to assist customers in successfully designing with the Vero product family of LED array products. For all available application notes visit www.bridgelux.com.

Optical Source Models

Optical source models and ray set files are available for all Bridgelux products. For a list of available formats, visit www.bridgelux.com.

3D CAD Models

Three dimensional CAD models depicting the product outline of all Bridgelux Vero LED arrays are available in both IGS and STEP formats. Please contact your Bridgelux sales representative for assistance.

LM80

LM80 testing has been completed and the LM80 report is now available. Please contact your Bridgelux sales representative for LM-80 report.

Precautions

CAUTION: CHEMICAL EXPOSURE HAZARD

Exposure to some chemicals commonly used in luminaire manufacturing and assembly can cause damage to the LED array. Please consult Bridgelux Application Note AN31 for additional information.

CAUTION: RISK OF BURN

Do not touch the Vero LED array during operation. Allow the array to cool for a sufficient period of time before handling. The Vero LED array may reach elevated temperatures such that could burn skin when touched.

CAUTION

CONTACT WITH LIGHT EMITTING SURFACE (LES)

Avoid any contact with the LES. Do not touch the LES of the LED array or apply stress to the LES (yellow phosphor resin area). Contact may cause damage to the LED array.

Optics and reflectors must not be mounted in contact with the LES (yellow phosphor resin area). Optical devices may be mounted on the top surface of the plastic housing of the Vero LED array. Use the mechanical features of the LED array housing, edges and/or mounting holes to locate and secure optical devices as needed.

Disclaimers

MINOR PRODUCT CHANGE POLICY

The rigorous qualification testing on products offered by Bridgelux provides performance assurance. Slight cosmetic changes that do not affect form, fit, or function may occur as Bridgelux continues product optimization.

STANDARD TEST CONDITIONS

Unless otherwise stated, array testing is performed at the nominal drive current.

About Bridgelux: We Build Light That Transforms

At Bridgelux, we help companies, industries and people experience the power and possibility of light. Since 2002, we've designed LED solutions that are high performing, energy efficient, cost effective and easy to integrate. Our focus is on light's impact on human behavior, delivering products that create better environments, experiences and returns—both experiential and financial. And our patented technology drives new platforms for commercial and industrial luminaires.

For more information about the company, please visit
bridgelux.com
twitter.com/Bridgelux
facebook.com/Bridgelux
youtube.com/user/Bridgelux
linkedin.com/company/bridgelux-inc-_2
WeChat ID: BridgeluxInChina



46430 Fremont Boulevard
Fremont, CA 94538
Tel (925) 583-8400
www.bridgelux.com

© 2016-2018 Bridgelux, Inc. All rights reserved 2018. Product specifications are subject to change without notice. Bridgelux, the Bridgelux stylized logo design, Vero, V Series and V Series HD are registered trademarks, and Decor Series is a trademark of Bridgelux, Inc. All other trademarks are the property of their respective owners.

Bridgelux Gen 7 Vero 18 Array Series Product Data Sheet DSg2 Rev. L (04/2018)