

4

3

2

1

NOTES: SEE SHEET 2.

If this document is printed it becomes uncontrolled. Check for the latest revision

REVISIONS			
LTR	DESCRIPTION	DATE	APPROVED
H	REVISED PER DCR# C061468	Jan/11/07	M.HIGGY
J	PER ECO-09-004669	Feb/24/09	M.HIGGY
K	PER ECO-11-008915	Apr/28/2011	M.HIGGY

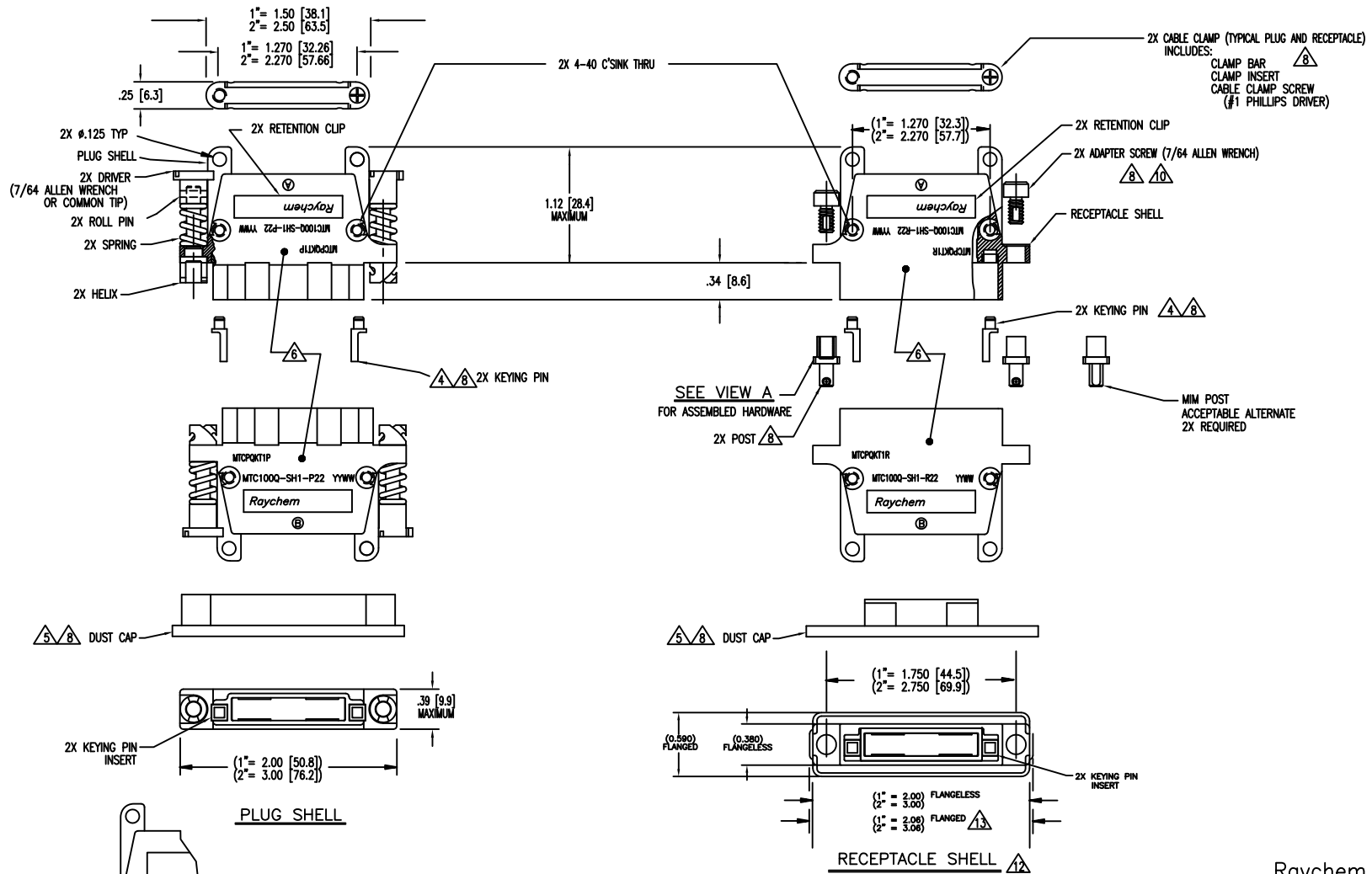

5/8 DUST CAP

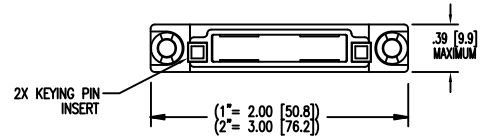

PLUG SHELL

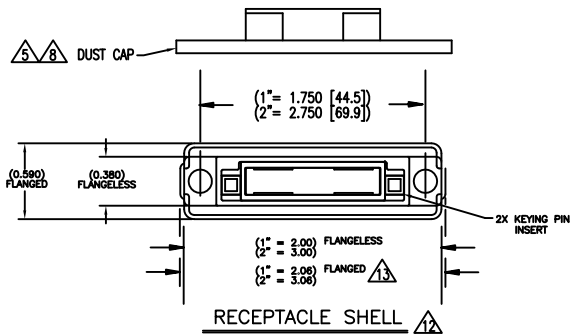

RECEPTACLE SHELL

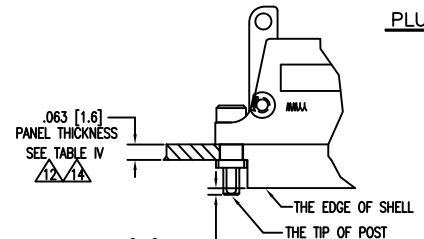

VIEW A ASSEMBLED HARDWARE

THE POST CAN BE .01 [0.3] MAX. ABOVE THE SHELL EDGE OR .02 [0.6] MAX. BELOW THE SURFACE.

THIS DRAWING AND THE INFORMATION SET FORTH HEREON ARE THE PROPERTY OF TYCO ELECTRONICS AND ARE TO BE HELD IN TRUST AND CONFIDENCE. PUBLICATION, DUPLICATION, DISCLOSURE OR USE FOR ANY PURPOSE NOT EXPRESSLY AUTHORIZED IN WRITING BY TYCO ELECTRONICS IS PROHIBITED.

© 2006-2011 Tyco Electronics. All rights reserved

Raychem MTC CUSTOMER DRAWING

UNLESS OTHERWISE SPECIFIED DIMENSIONS ARE IN INCHES. METRIC DIMENSIONS ARE IN BRACKETS.	DRAWN	T.SEATON	96JUN28	TE Connectivity	TITLE	SHELL, PLUG AND RECEPTACLE		
	CHECKED					MTC100Q SERIES		
DECIMALS	APPROVED	P.DUTTON	96JUL03	CAD NAME	MTC100Q-SHX-X2X-XXX			
.XXX ±.005				THIRD ANGLE PROJECTION	SIZE	CAGE CODE:	DWG. NO.	REV
.XX ±.02					C	06090	MTC100Q-SHX-X2X-XXX	K
ANGLES					SCALE:	NONE		SHEET 1 OF 3
.X ±								
WEIGHT:								

4

3

2

1

DWG. NO. MTC100Q-SHX-X2X-XXX 1

4

3

2

1

NOTES:

1. SHELL PART NUMBER VARIABLES: (NOT ALL POSSIBLE CONFIGURATIONS SHOWN ON THIS DRAWING ARE AVAILABLE AS STANDARD PRODUCTS. PLEASE CHECK WITH RAYCHEM TO CONFIRM AVAILABILITY.)

MTC100Q-SHX-X2X-XXX

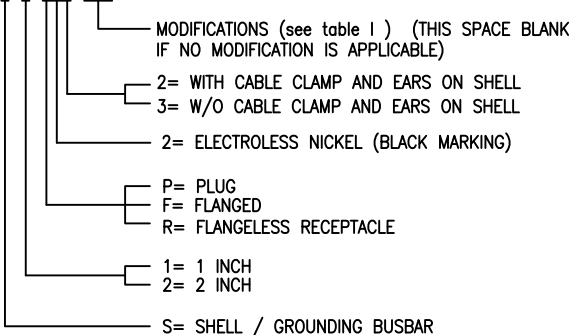

2. MATERIAL:

- A) SHELL ALUMINUM ALLOY PER ASTM B85
- B) RETENTION CLIP COPPER ALLOY 172 PER ASTM B194
- C) CAP SCREW STAINLESS STEEL PER SAE-AMS-QQ-S-763, 300 SERIES
- D) POST * STAINLESS STEEL , PER AISI 17-4 PH
- E) ROLL PIN STAINLESS STEEL PER SAE-AMS 5673, 400 SERIES
- F) KEYING PIN HIGH GRADE POLYARYLENE THERMOPLASTIC, MOLDED
- G) KEY PINS INSERT HIGH GRADE POLYARYLENE THERMOPLASTIC, MOLDED
- H) CLAMP BAR STAINLESS STEEL PER SAE-AMS-QQ-S-763, 300 SERIES
- J) CLAMP INSERT SILICONE ELASTOMER PER MIL-DTL-25988B
- K) DRIVER * STAINLESS STEEL , PER AISI 17-4 PH
- L) SPRING STAINLESS STEEL PER AMS 5673, 17-7 PH
- L) HELIX * STAINLESS STEEL , PER AISI 17-4 PH

* ACCEPTABLE ALTERNATE, STAINLESS STEEL, PER MPIF STD 35, MIM-17-4 PH

3. FINISH:

APPLIES TO NICKEL PLATED CONNECTORS

- A) SHELL NICKEL PLATED PER SAE-AMS-C-26074 CLASS 3, GRADE B
- B) RETENTION CLIP NICKEL PLATED PER SAE-AMS-C-26074 CLASS 2, .00002 MINIMUM
- C) POST CAP SCREW PASSIVATED PER SAE-AMS-QQ-P-35
- D) POST NICKEL TEFLON PLATED PER TECHMETALS 117C
- E) HELIX NICKEL TEFLON PLATED PER TECHMETALS 117C
- F) ROLL PIN PASSIVATED PER SAE-AMS-QQ-P-35
- G) DRIVER PASSIVATED PER SAE-AMS-QQ-P-35

- 4 KEYING PIN IS SUPPLIED UNINSTALLED, USER TO PRESS INTO PROPER KEYING POSITION. SEE TABLE 5 FOR STANDARD KEYING PIN POSITIONS. FOR ADDITIONAL KEYING OPTIONS REFER TO D-659-0080.
- 5 STANDARD (RED) DUST CAP ARE SUPPLIED WITH EACH PLUG AND RECEPTACLE. SEE TABLE VI FOR MORE INFORMATION.
- 6 APPROPRIATE PART NUMBERS AND DATE CODES ARE STAMPED APPROXIMATELY AS SHOWN ON "B" SIDE. ALL "A" SIDE MARKINGS ARE OPTIONAL.
- 7. THESE PARTS MEET THE REQUIREMENTS OF TE SPECIFICATION C-6114.
- 8 THESE ITEMS ARE SUPPLIED UNASSEMBLED.
- 9 SEE TABLE II SHEET 3, WEIGHTS ARE WITHOUT DUST CAP.
- 10 RECEPTACLE POST SCREWS (CAP SCREWS) ARE TO BE TORQUED TO 15±1 INCH-LBS (1.0±0.07 N-M)
- 11 PLUG AND RECEPTACLE SHELLS ARE DESIGNED TO ACCEPT EITHER PIN OR SOCKET INSERTS. OR MIXED IN THE TWO INCHES STYLE.
- 12 THIS RECEPTACLE IS RECOMMENDED FOR REAR PANEL MOUNTING APPLICATION. REMOVING AS MANY PANEL WASHERS AS REQUIRED TO ACCOMMODATE THE THICKNESS OF THE PANEL BEING USED. SEE SHEET 3, TABLE 4, FIGURE 1. USE ONLY SCREWS SUPPLIED WITH CONNECTOR. POST TO BE FLUSH WITHIN TOLERANCE AS SHOWN SEE VIEW 'A' PAGE # 1.
- 13 WHEN MOUNTING FLANGELESS CONNECTORS ADJACENT TO ONE ANOTHER AND USING THE .400 MINIMUM CENTERLINE LOCATION, THERE WILL BE NO WEB BETWEEN PANEL CUT-OUTS. SEE SHEET 3, TABLE 3, FOR DETAILS.
- 14 THE HARDWARE FOR THIS CONNECTOR IS DESIGNED TO BE USED ON 0.063 INCH PANEL THICKNESS. OTHERWISE 2 THIN WASHERS (PANEL WASHERS) ARE REQUIRED FOR EACH POST. USE PART D-659-0042.

TABLE I (MODIFICATIONS)

MODIFICATION DASH NUMBER	DESCRIPTION
-022	SAME AS STANDARD ASSEMBLY, EXCEPT CONTACTS AND SEALING PLUGS ARE INCLUDED.
-023	SAME AS STANDARD ASSEMBLY, EXCEPT CONTACTS SEALING PLUGS AND INSERTION / EXTRACTION TOOL ARE INCLUDED.

If this document is printed it becomes uncontrolled. Check for the latest revision

© 2006-2011 Tyco Electronics. All rights reserved

Roychem MTC CUSTOMER DRAWING

DWG. NO.	REV
MTC100Q-SHX-X2X-XXX	K
CAD FILE: MTC100Q-SHX-X2X-XXX	SHEET 2 OF 3

4

3

2

1

DWG NO. MTC100Q-SHX-X2X-XXX SHEET 2

THE FOLLOWING TABLE CONSISTS OF WEIGHTS FOR THESE SPECIFIC PART NUMBERS.

PART NUMBER	WEIGHT MAXIMUM GRAMS
MTC100Q-SH1-F22	29.9
MTC100Q-SH1-P22	29.5
MTC100Q-SH1-R22	26.2
MTC100Q-SH2-F22	40.5
MTC100Q-SH2-P22	39.7
MTC100Q-SH2-R22	36.4
MTC100Q-SH1-F23	19.0
MTC100Q-SH1-P23	21.9
MTC100Q-SH1-R23	18.6
MTC100Q-SH2-F23	28.9
MTC100Q-SH2-P23	28.1
MTC100Q-SH2-R23	24.7

PANEL THICKNESS	NUMBER OF PANEL WASHERS FOR EACH FASTENER
0	2
0.031/0.036 [0.8]/[0.9]	1
0.062/0.067 [1.5]/[1.7]	0

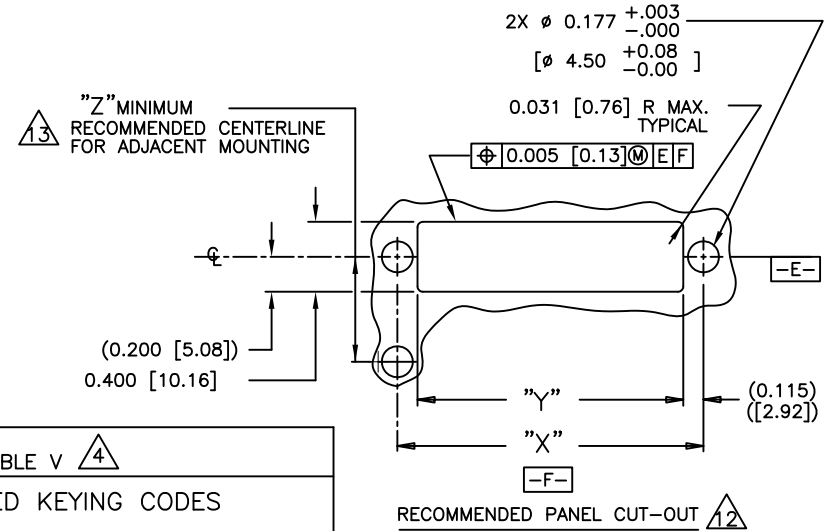

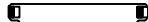

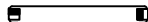

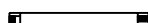
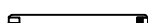





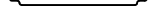
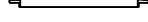

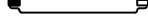

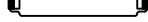



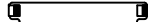
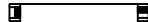
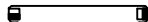

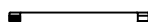

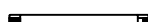



FIGURE 1

CONNECTOR SIZE	TYPE:	"X"	"Y"	"Z" (MIN)
1 INCH	FLANGELESS	1.750 [44.5]	1.520 [38.6]	0.400 [10.16]
	FLANGED	1.750 [44.5]	1.520 [38.6]	0.600 [15.24]
2 INCH	FLANGELESS	2.750 [69.9]	2.520 [64.0]	0.400 [10.16]
	FLANGED	2.750 [69.9]	2.520 [64.0]	0.600 [15.24]

RECOMMENDED DUST CAP					
ITEM	PART NUMBER	USED WITH SHELL		DUCT CAP MATERIAL	
		SIZE	TYPE	POLYETHYLENE RED	ELECTROSTATIC PINK
1	D-659-0060	1"	PLUG	X	
2	D-659-0062	2"	PLUG	X	
3	CHA-1603	1"	RECEPTACLE	X	
4	CHA-1604	2"	RECEPTACLE	X	
5	CHA-0098	1"	PLUG		X
6	CHA-0100	2"	PLUG		X
7	CHA-0311	1"	RECEPTACLE		X
8	CHA-0312	2"	RECEPTACLE		X

SUGGESTED KEYING CODES		
	-A A-	
	-A B-	
	-A C-	
	-A D-	
	-B A-	
	-B B-	
	-B C-	
	-B D-	
	-C A-	
	-C B-	
	-C C-	
	-C D-	
	-D A-	
	-D B-	
	-D C-	
	-D D-	

RECEPTACLE FACE PLUG FACE

WHEN USING STANDARD RECTANGULAR KEYING PINS

If this document is printed it becomes uncontrolled. Check for the latest revision

DWG. NO. MTC100Q-SHX-X2X-XXX SHEET 3