

HANDLING AREA

AREA REQUIRED TO MATE
AND UNMATE THE CONNECTOR

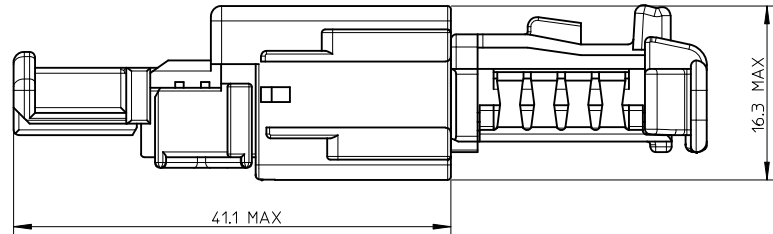
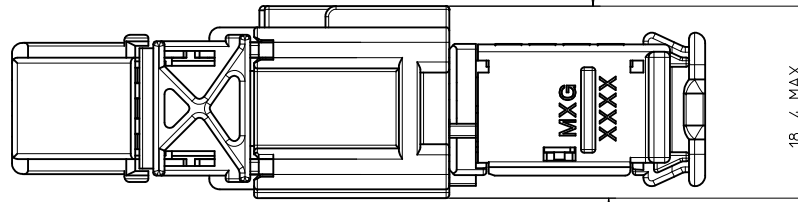

NOTE : 1 - The using conditions are shown in the MOLEX specification n°AS-98821-001.

2 - Male terminal used : SICMA 3 1.5mm

3 - Male connector will mate with female connector P/N 098817102x

AREA REQUIRED WHEN THE CONNECTOR IS MATED

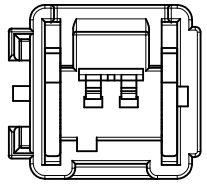
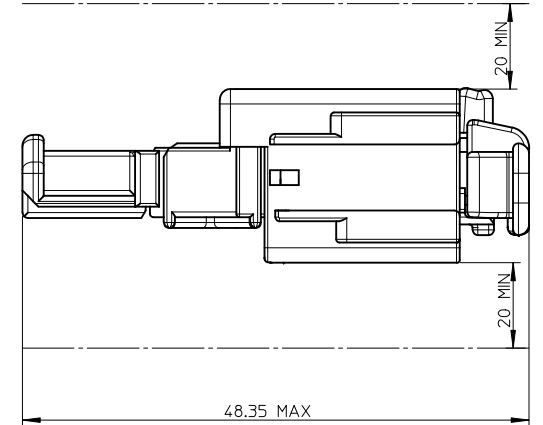

WHITE CODING
P/N 0988221020

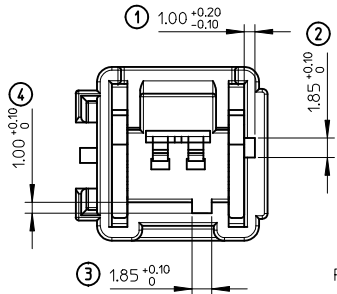

BLACK CODING
P/N 0988221021

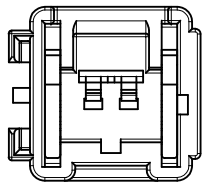

GREY CODING
P/N 0988221028

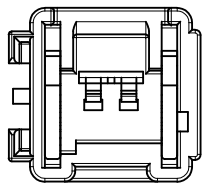

GREEN CODING
P/N 0988221025

<p>FIRST RELEASE EC NO: G2012-0103 DRAWN BY: VJOUAS 2012/01/12 CHKD: AHERBELIN 2011/01/13 APPR: OPLESSIS 2012/01/26</p>	<p>QUALITY SYMBOLS</p> <p>▽=0</p> <p>▽=0</p> <p>▽=0</p>	<p>GENERAL TOLERANCES (UNLESS SPECIFIED)</p>		<p>DIMENSION STYLE</p> <p>MM ONLY</p>	<p>SCALE</p> <p>3:1</p>	<p>DESIGN UNITS</p> <p>METRIC</p>	<p>FIRST ANGLE PROJECTION</p>			
		<p>4 PLACES ± --- ± ---</p>	<p>3 PLACES ± --- ± ---</p>	<p>2 PLACES ± --- ± ---</p>	<p>1 PLACE ± 0.1 ± ---</p>	<p>mm</p>	<p>INCH</p>	<p>DRAWN BY: VJOUAS 2012/01/12</p>	<p>DATE: 2012/01/12</p>	<p>TITLE</p> <p>NSCC PIN CONN 1.5 2CKT</p>
		<p>ANGULAR ± 1°</p>		<p>DRAFT WHERE APPLICABLE MUST REMAIN WITHIN DIMENSIONS</p>		<p>APPROVED BY: OPLESSIS 2012/01/26</p>	<p>DATE: 2012/01/26</p>	<p>MATERIAL NO.</p> <p>SEE SHEET 2</p>	<p>DOCUMENT NO.</p> <p>SD-98822-004</p>	
		<p>SIZE</p> <p>A 2</p>		<p>THIS DRAWING CONTAINS INFORMATION THAT IS PROPRIETARY TO MOLEX INCORPORATED AND SHOULD NOT BE USED WITHOUT WRITTEN PERMISSION</p>						<p>SHEET NO.</p> <p>1 OF 2</p>

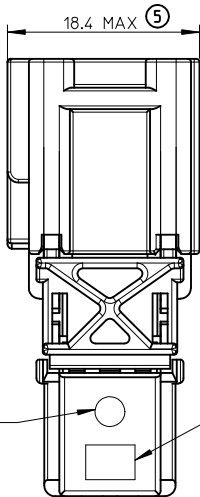

0988221028	GREY
0988221025	GREEN
0988221021	BLACK
0988221020	WHITE
PART NUMBER	COLOR
ASSEMBLY PART	

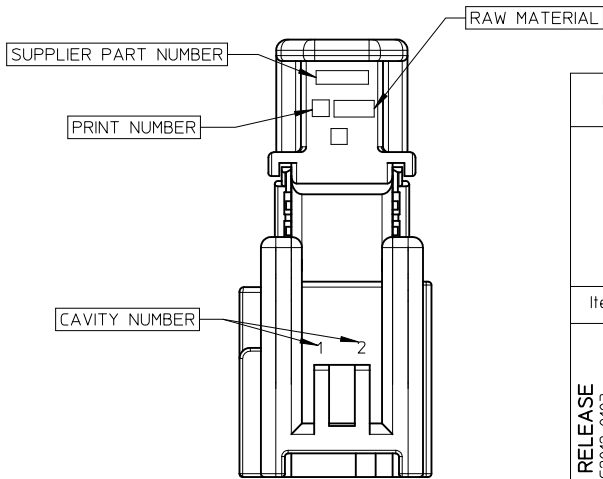
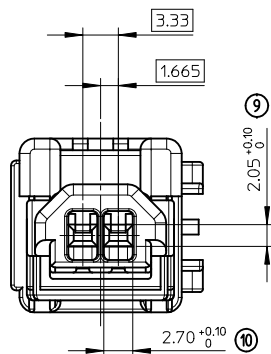
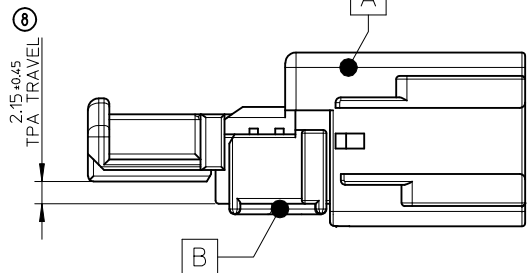
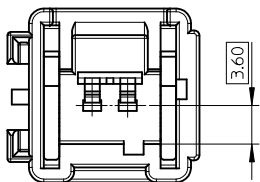
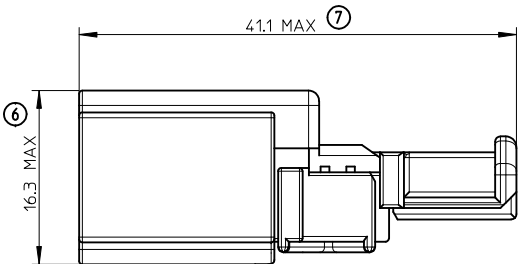
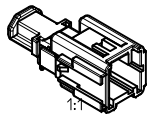

BLACK CODING (P/N 0988221021) IS SHOWN.

Item	Description	Part-number	Color	Raw Material	Weight effective (g)
B	SCC Pin Conn 15x0.8 TPA 2Ckt	0988220124	Yellow	POLYAMIDE >PA66-GF20<	4.508
A	SCC Pin Conn Unseated 15x0.8 2Ckt	0988220028	Grey	POLYESTER >PBT<	
		0988220025	Green		
		0988220021	Black		
		0988220020	White		

FIRST RELEASE EC NO: G2012-0103 DRAWN: VJOUAS 2012/01/12 CHKD: AHERBEL IN 2011/01/13 APPR: OPLESSIS 2012/01/26	QUALITY SYMBOLS ▽=0 ▽=0 ▽=0	GENERAL TOLERANCES (UNLESS SPECIFIED)		DIMENSION STYLE MM ONLY		SCALE 3:1	DESIGN UNITS METRIC	FIRST ANGLE PROJECTION	
		4 PLACES ± --- ± ---	mm INCH	DRAWN BY VJOUAS	DATE 2012/01/12	TITLE NSSC PIN CONN 1.5 2CKT			
		3 PLACES ± --- ± ---		CHECKED BY AHERBEL IN	DATE 2011/01/13				
		2 PLACES ± --- ± ---		APPROVED BY OPLESSIS	DATE 2012/01/26	MATERIAL NO. SD-98822-004			
1 PLACE ± 0.1 ± ---		ANGULAR ± 1 °		DRAFT WHERE APPLICABLE MUST REMAIN WITHIN DIMENSIONS		SEE CHART		DOCUMENT NO.	
				SIZE A2		THIS DRAWING CONTAINS INFORMATION THAT IS PROPRIETARY TO MOLEX INCORPORATED AND SHOULD NOT BE USED WITHOUT WRITTEN PERMISSION		SHEET NO. 2 OF 2	