

GloTek, Inc. www.globtek.com 186 Veterans Drive, Northvale, NJ 07647 Tel. (201) 784-1000 Fax (201) 784-0111	Drawing Title: GT-83083-0505-USB-W2, ITE Power Supply, Efficiency Level: VI, Case Color/Style: White C-62, Wall Plug-in, AC/DC Switching Adapter with USB Power Supply AC Adaptor, Input Rating: 100-240V- , 50/60Hz, N. America NEMA 1-15 Fixed , Output Rating: 5W, 5V@1A, Output Configuration: N/A mm, N/A/4 Cond, N/A, Type "A" USB "JACK", integral to power supply enclosure, Ferrite: None, N/A, GT Cord # C0132, Pin Out: Pin 1: (+), Pin 2: Connected to Pin 3, Pin 3: Connected to Pin 2, Pin 4: (-); P2 and P3 are shorted together inside Power supply, Blades/Input Cord: Fixed Blades North American 1-15P, Approvals: Double Insulation Level VI PSE RoHS VCCI WEEE LPS cULus CB		
	Model No. GT-83083-0505-USB-W2		
	Part No./Ordering No. WR9HA1000USB-F(R6W)		Rev G

REVISION HISTORY

REV	DESCRIPTION	SUB	DATE	APPROVED
G	Add Label drawing to deviation	QA	08/09/2016	QA
F	Add SIQ and CE marks are not needed for North America to deviation.	emcna	07/26/2016	QA
E	Correct grounding diagram to Class II.	emcna	07/19/2016	QA
D	Update white color to C62.	emcna	06/29/2016	QA
C	Add to notes/deviations need for Laser Engraved label.	emcna	06/17/2016	QA
B	Update label approvals. Add UL.	emcna	04/26/2016	QA
A	Initial release.	emcna	09/04/2015	QA

In Addition to GlobTek Inc.'s renewed ISO9001:2008 - Quality Management System Certification, GlobTek Inc. is now certified to:

ISO13485:2003 - Medical Devices Quality Management System Certification
ISO14001:2004 - Environmental Management System Certification

ISO Certificates are available online at <http://www.globtek.com/iso-certificates/>

Customer Approval of Specification:

Please approve, sign and send back to GlobTek so we can complete order processing.

A delay in receipt of this form will delay delivery schedule.

Company Name:

Customer P/N:

Quote Number:

Date:

Authorized Representative Name:

Authorized Representative Signature:

The acceptance of this specification and use of the product described in this document indicates the acceptance and binding of the customer to Globtek terms and conditions, which supersede all other agreements, terms, and conditions (<http://en.globtek.com/terms-and-conditions/>).

Footnote:

GlobTek Inc. will not be liable for the safety and performance of these power supplies if unauthorized access and repair occurs. End user should consult applicable UL, CSA or EN standards for proper installation instruction.

Limitation of Use:

GlobTek product are not authorized for use as mission critical components in life support hazardous environment, nuclear or aircraft applications without prior written approval from the CEO of GlobTek Inc.

Contents of this document are subject to change without prior notice.

GT-83083-0505-USB-W2, 5W, 5V@1A, Wall Plug-in, AC/DC Switching Adapter with USB Power Supply AC Adaptor

PROPRIETARY INFORMATION

PROPRIETARY OF GLOBTEK, INC. ANY REPRODUCTION, DISCLOSURE OR USE OF THIS DRAWING, IN WHOLE OR IN PART, IS HEREBY PROHIBITED EXCEPT AS SPECIFIED IN WRITING BY GLOBTEK, INC.

Page 1 of 10

quest /08/20/2018 7:42:33 AM

GlobTek, Inc. www.globtek.com 186 Veterans Drive, Northvale, NJ 07647 Tel. (201) 784-1000 Fax (201) 784-0111	Drawing Title: GT-83083-0505-USB-W2, ITE Power Supply, Efficiency Level: VI, Case Color/Style: White C-62, Wall Plug-in, AC/DC Switching Adapter with USB Power Supply AC Adaptor, Input Rating: 100-240V- , 50/60Hz, N. America NEMA 1-15 Fixed , Output Rating: 5W, 5V@1A, Output Configuration: N/A mm, N/A/4 Cond, N/A, Type "A" USB "JACK", integral to power supply enclosure, Ferrite: None, N/A, GT Cord # C0132, Pin Out: Pin 1: (+), Pin 2: Connected to Pin 3, Pin 3: Connected to Pin 2, Pin 4: (-); P2 and P3 are shorted together inside Power supply, Blades/Input Cord: Fixed Blades North American 1-15P, Approvals: Double Insulation Level VI PSE RoHS VCCI WEEE LPS cULus CB	
	Model No. GT-83083-0505-USB-W2	
	Part No./Ordering No. WR9HA1000USB-F(R6W)	Rev G

POWER SUPPLY INFORMATION

TYPE: Wall Plug-in
TECHNOLOGY: AC/DC Switching Adapter with USB Power Supply AC Adaptor
CASE COLOR: White C-62
NAMEPLATE RATED INPUT: 100-240V- , 50/60Hz, 0.2A
INPUT CONFIG: N. America NEMA 1-15 Fixed
WATTS: 5.0
VOLTS OUT: 5
CURRENT OUT (Amps): 1
BLADE/CORD INCLUDED: FBNA2:
BLADE/CORD INSTALLED: FBNA2:
GROUNDING CONFIGURATION (F1) Class II / Double Insulated
EFFICIENCY LEVEL: VI
OUTPUT CONFIGURATION N/A mm, N/A/4 Cond, N/A, Type "A" USB "JACK", integral to power supply enclosure, Ferrite: None, N/A, GT Cord # C0132
CONNECTOR PIN OUT: Pin 1: (+), Pin 2: Connected to Pin 3, Pin 3: Connected to Pin 2, Pin 4: (-); P2 and P3 are shorted together inside Power supply
LABEL SPECS: Standard GT WHITE,L-1288
PACK SPEC: Standard with USB Jack, Individually Box

Notes/Modifications/Customizations (notes in this section supersede the values shown in the standard spec):

Label Note:
Laser Engraved label is required.
SIQ and CE marks are not needed for North America to deviation.

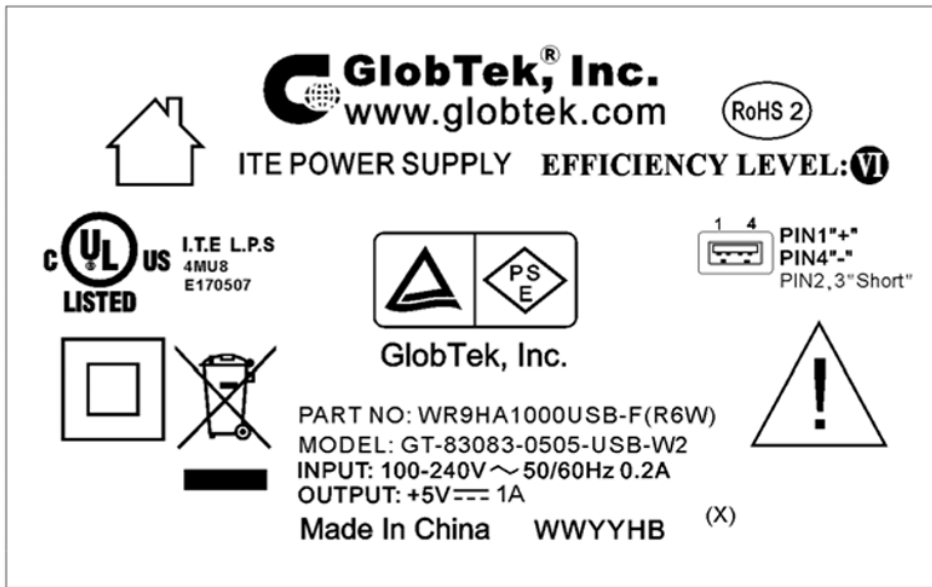

DIMENSIONS ARE IN MM UNLESS SPECIFIED OTHERWISE.

GlobTek, Inc. www.globtek.com 186 Veterans Drive, Northvale, NJ 07647 Tel. (201) 784-1000 Fax (201) 784-0111	Drawing Title: GT-83083-0505-USB-W2, ITE Power Supply, Efficiency Level: VI, Case Color/Style: White C-62, Wall Plug-in, AC/DC Switching Adapter with USB Power Supply AC Adaptor, Input Rating: 100-240V- , 50/60Hz, N. America NEMA 1-15 Fixed , Output Rating: 5W, 5V@1A, Output Configuration: N/A mm, N/A/4 Cond, N/A, Type "A" USB "JACK", integral to power supply enclosure, Ferrite: None, N/A, GT Cord # C0132, Pin Out: Pin 1: (+), Pin 2: Connected to Pin 3, Pin 3: Connected to Pin 2, Pin 4: (-); P2 and P3 are shorted together inside Power supply, Blades/Input Cord: Fixed Blades North American 1-15P, Approvals: Double Insulation Level VI PSE RoHS VCCI WEEE LPS cULus CB	
	Model No. GT-83083-0505-USB-W2	
	Part No./Ordering No. WR9HA1000USB-F(R6W)	Rev G

ELECTRICAL SPECIFICATIONS

01. Input Voltage: Specified 90-264 Vac, Nameplate rated: 100-240Vac
02. Input Frequency: Specified 47-63 Hz, Nameplate rated 50-60Hz
03. Output Regulation: +/- 5% measured at the output connector measured at the end of a 0.6 meter USB cordset employing #22 Gauge conductors
04. Line Voltage Regulation: +/- 1% typical measured at the output connector measured at the end of a 0.6 meter USB cordset employing #22 Gauge conductors
05. Output Ripple (Vp-p): +/-1% or 100 mV whichever is greater measured at the end of a 0.6 meter USB cordset employing #22 Gauge conductors. Measured at 20 MHz bandwidth with 0.1 uf ceramic capacitor in parallel with 10 uf electrolytic capacitor connected at the end of the output connector.
06. Inrush Current: at full load, 25°C, cold start
07. Switching Frequency: 100 KHz typical, varies with line and load
08. Efficiency: 73.77% minimum at nominal input voltage average, Efficiency meet CEC , ERP2009/125/EC

B) PROTECTION

01. Over-current protection: 1.5A maximum with auto-recovery function
02. Over-voltage protection: 10VDC maximum with zener clamp
03. Short-circuit protection:The adapter shall not be damaged by short the DC output to Ground.

C) SAFETY

01. Dielectric Withstand Voltage: Primary To Secondary: 3000VAC 10mA 1minute or 4242VDC 10mA 1minute
02. Leakage Current: 20uA maximum, at nominal AC input voltage and frequency
03. ESD Immunity per EN61000-4-2, ±8 kV contact, ±15 kV air, Perf Criteria A Standard.

D) OTHER:

01. MTBF: 200,000 Hours @ 25°C ambient temperature
02. Operating Temperature: 0°C to 50°C ambient temperature
03. Operating Humidity: 20 ~ 85 % RH. non-condensing
05. Storage Temperature: -20°C to 60°C
06. Storage Humidity:5 ~ 95 % RH. non-condensing
07. Cooling: Cooling shall be with natural convection cooling
08. RoHS 2: Complies with EU 2011/65/EU China SJ/T 11364-2014

E) ENCLOSURE

01. Housing: High impact plastic, 94V0 polycarbonate, non-vented

PROPRIETARY INFORMATION

PROPRIETARY OF GLOBTEK, INC. ANY REPRODUCTION, DISCLOSURE OR USE OF THIS DRAWING, IN WHOLE OR IN PART, IS HEREBY PROHIBITED EXCEPT AS SPECIFIED IN

WRITING BY GLOBTEK, INC.

quest /08/20/2018 7:42:33 AM

GlobTek, Inc.
 www.globtek.com
 186 Veterans Drive,
 Northvale, NJ 07647
 Tel. (201) 784-1000
 Fax (201) 784-0111

Drawing Title: GT-83083-0505-USB-W2, ITE Power Supply, Efficiency Level: VI, Case Color/Style: White C-62, Wall Plug-in, AC/DC Switching Adapter with USB Power Supply AC Adaptor, Input Rating: 100-240V- , 50/60Hz, N. America NEMA 1-15 Fixed , Output Rating: 5W, 5V@1A, Output Configuration: N/A mm, N/A/4 Cond, N/A, Type "A" USB "JACK", integral to power supply enclosure, Ferrite: None, N/A, GT Cord # C0132, Pin Out: Pin 1: (+), Pin 2: Connected to Pin 3, Pin 3: Connected to Pin 2, Pin 4: (-); P2 and P3 are shorted together inside Power supply, Blades/Input Cord: Fixed Blades North American 1-15P, Approvals: Double Insulation Level VI PSE RoHS VCCI WEEE LPS cULus CB

Model No. GT-83083-0505-USB-W2

Part No./Ordering No. WR9HA1000USB-F(R6W)

Rev G

02. Markings: Label and/or Pad Printed and/or Molded in the case

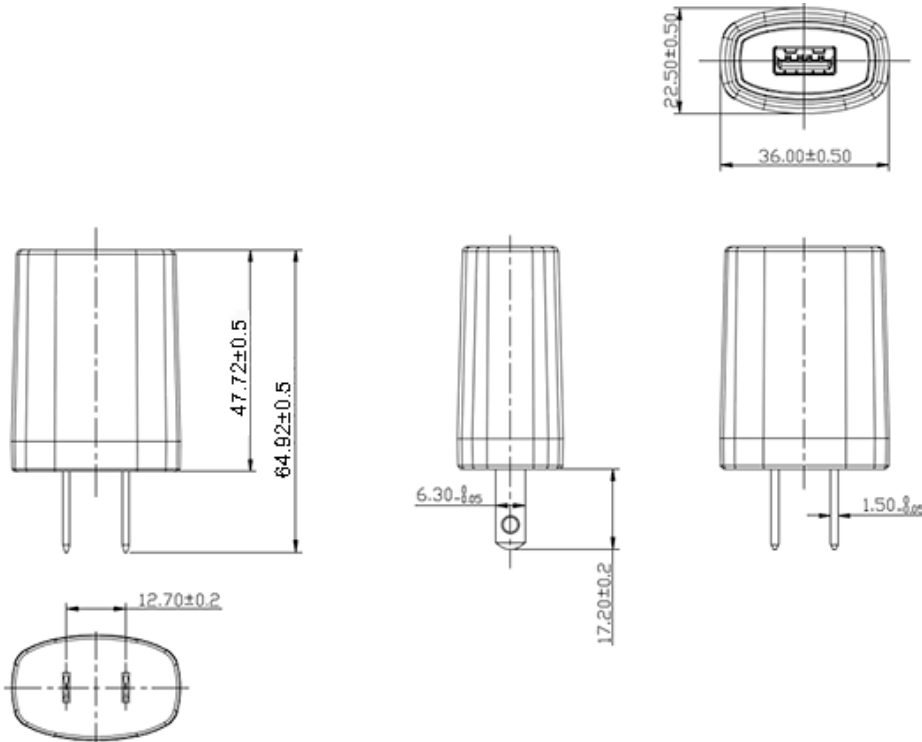

GlobTek, Inc. www.globtek.com 186 Veterans Drive, Northvale, NJ 07647 Tel. (201) 784-1000 Fax (201) 784-0111	Drawing Title: GT-83083-0505-USB-W2, ITE Power Supply, Efficiency Level: VI, Case Color/Style: White C-62, Wall Plug-in, AC/DC Switching Adapter with USB Power Supply AC Adaptor, Input Rating: 100-240V- , 50/60Hz, N. America NEMA 1-15 Fixed , Output Rating: 5W, 5V@1A, Output Configuration: N/A mm, N/A/4 Cond, N/A, Type "A" USB "JACK", integral to power supply enclosure, Ferrite: None, N/A, GT Cord # C0132, Pin Out: Pin 1: (+), Pin 2: Connected to Pin 3, Pin 3: Connected to Pin 2, Pin 4: (-); P2 and P3 are shorted together inside Power supply, Blades/Input Cord: Fixed Blades North American 1-15P, Approvals: Double Insulation Level VI PSE RoHS VCCI WEEE LPS cULus CB	
	Model No. GT-83083-0505-USB-W2	
	Part No./Ordering No. WR9HA1000USB-F(R6W)	Rev G

INPUT CONFIGURATION

Grounding Configuration:

Blades/Cord Included: FBNA2:

Blades/Cord Installed: FBNA2:

NEMA 1-15P, North America Blades, Class II 2 Conductors

All NEMA 1 devices are two-wire non-grounding devices (hot-neutral) rated for 125 V maximum. NEMA 1-15P plugs have two parallel flat blades, 0.25 inches (6.35 mm) wide, 0.06 inches (1.524 mm) thick, 0.625-0.718 inches (15.875–18.256 mm) long, and spaced 0.5 inches (12.7 mm) apart.

GloTek, Inc. www.globtek.com 186 Veterans Drive, Northvale, NJ 07647 Tel. (201) 784-1000 Fax (201) 784-0111	Drawing Title: GT-83083-0505-USB-W2, ITE Power Supply, Efficiency Level: VI, Case Color/Style: White C-62, Wall Plug-in, AC/DC Switching Adapter with USB Power Supply AC Adaptor, Input Rating: 100-240V- , 50/60Hz, N. America NEMA 1-15 Fixed , Output Rating: 5W, 5V@1A, Output Configuration: N/A mm, N/A/4 Cond, N/A, Type "A" USB "JACK", integral to power supply enclosure, Ferrite: None, N/A, GT Cord # C0132, Pin Out: Pin 1: (+), Pin 2: Connected to Pin 3, Pin 3: Connected to Pin 2, Pin 4: (-); P2 and P3 are shorted together inside Power supply, Blades/Input Cord: Fixed Blades North American 1-15P, Approvals: Double Insulation Level VI PSE RoHS VCCI WEEE LPS cULus CB	
	Model No. GT-83083-0505-USB-W2	
	Part No./Ordering No. WR9HA1000USB-F(R6W)	Rev G

OUTPUT CORD AND CONNECTOR: USBMT/C0132

ACTUAL CONNECTORS, OVERMOLDS, FERRITES MAY VARY SLIGHTLY FROM THE PICTURE BELOW

CABLE TYPE	N/A
CABLE LENGTH (mm)	N/A
CABLE TOLERANCE (mm)	N/A
WIRE GAUGE (AWG)	N/A
CONDUCTORS	4
HANK DIMENSION (mm)	N/A
CABLE / CONNECTOR OVERMOLD COLOR	N/A
FERRITE TYPE / DIMENSION	None
FERRITE # OF TURNS (Definition)	N/A
FERRITE DIMENSION FROM STRAIN RELIEF	N/A
FERRITE DIMENSION FROM PLUG	N/A
PLUG TYPE	Type "A" USB "JACK", integral to power supply enclosure
OVER MOLD ORIENTATION	PCB Mount Connector
CONNECTOR PIN OUT:	Pin 1: (+), Pin 2: Connected to Pin 3, Pin 3: Connected to Pin 2, Pin 4: (-); P2 and P3 are shorted together inside Power supply
ADDITIONAL REQUIREMENTS	

Front View

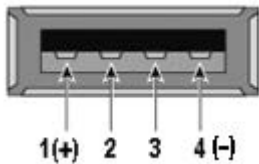

ADDITIONAL OUTPUT PLUG OPTIONS ARE AVAILABLE AT <http://www.globtek.com/connectors/>
STANDARD PLUGS AND CONNECTORS CAN BE SEEN ONLINE AT <http://www.globtek.com/connectors/>

GlobTek, Inc. www.globtek.com 186 Veterans Drive, Northvale, NJ 07647 Tel. (201) 784-1000 Fax (201) 784-0111	Drawing Title: GT-83083-0505-USB-W2, ITE Power Supply, Efficiency Level: VI, Case Color/Style: White C-62, Wall Plug-in, AC/DC Switching Adapter with USB Power Supply AC Adaptor, Input Rating: 100-240V- , 50/60Hz, N. America NEMA 1-15 Fixed , Output Rating: 5W, 5V@1A, Output Configuration: N/A mm, N/A/4 Cond, N/A, Type "A" USB "JACK", integral to power supply enclosure, Ferrite: None, N/A, GT Cord # C0132, Pin Out: Pin 1: (+), Pin 2: Connected to Pin 3, Pin 3: Connected to Pin 2, Pin 4: (-); P2 and P3 are shorted together inside Power supply, Blades/Input Cord: Fixed Blades North American 1-15P, Approvals: Double Insulation Level VI PSE RoHS VCCI WEEE LPS cULus CB	
	Model No. GT-83083-0505-USB-W2	
	Part No./Ordering No. WR9HA1000USB-F(R6W)	Rev G

LABEL:L-1288

LABEL P/N: Standard GT WHITE
MATERIAL: Flat Thermal Transfer, Imprintable, Polyester Label and/or Pad Printed and/or Molded in the case
BACKGROUND COLOR: Black if housing is Black, White or Silver if housing is White or Gray.
TEXT COLOR: White or Silver if label is Black Background for Black housing. Black if label is White or Silver background and Housing is White or Gray
LABEL WIDTH (mm): 30.0
LABEL HEIGHT (mm): 24.0

Below is the minimum information which will appear on the label. NOTE: in the logo area additional/actual positioning of symbols and text is subjected to change as per agency updates/requirements or additional model approvals become available. Agency logos may be in Logo area on the label or molded into the case housing outside the label area. Information will be shown via Label and/or Pad Printed and/or Molded in the case

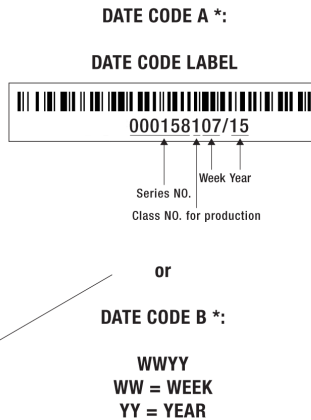

A=ITE Power Supply
 B=P/N: (料号) WR9HA1000USB-F(R6W)
 C=Model (型号) GT-83083-0505-USB-W2
 D=Input (输入) 100-240V- , 50/60Hz, 0.2A
 E=Output (输出) 5 V  1 A , 5.0W

- | | |
|---|---|
| AGENCY ONLINE DOCUMENTS | http://www.globtek.info/certs/GT-83083-USB-W2Z/ |
| CE EC-Declaration for Medical | Contact GlobTek for more information |
| CE EC-Declaration for Industrial/Commercial/ITE | http://www.globtek.com/pdf/ec_declaration/a00a000000MEmurEAD |
| RoHS/RoHS2 Declaration | http://www.globtek.com/pdf/rohs_cert/01ta0000005qSvHAAU |
| REACH Declaration | http://www.globtek.com/pdf/iso_certificates/REACH.pdf |
| Conflict Minerals Declaration | http://www.globtek.com/pdf/conflict-minerals.pdf |

GlobTek, Inc. www.globtek.com 186 Veterans Drive, Northvale, NJ 07647 Tel. (201) 784-1000 Fax (201) 784-0111	Drawing Title: GT-83083-0505-USB-W2, ITE Power Supply, Efficiency Level: VI, Case Color/Style: White C-62, Wall Plug-in, AC/DC Switching Adapter with USB Power Supply AC Adaptor, Input Rating: 100-240V- , 50/60Hz, N. America NEMA 1-15 Fixed , Output Rating: 5W, 5V@1A, Output Configuration: N/A mm, N/A/4 Cond, N/A, Type "A" USB "JACK", integral to power supply enclosure, Ferrite: None, N/A, GT Cord # C0132, Pin Out: Pin 1: (+), Pin 2: Connected to Pin 3, Pin 3: Connected to Pin 2, Pin 4: (-); P2 and P3 are shorted together inside Power supply, Blades/Input Cord: Fixed Blades North American 1-15P, Approvals: Double Insulation Level VI PSE RoHS VCCI WEEE LPS cULus CB	
	Model No. GT-83083-0505-USB-W2	
	Part No./Ordering No. WR9HA1000USB-F(R6W)	Rev G

IPXY rating is based on 3rd party testing and customers should check suitability and test system level IPXY rating before ordering.

Regulatory Certifications/Label Markings

LATEST PRODUCT/MODEL CERTIFICATIONS: <http://en.globtek.com/datasheet/id/a00a000000MEmur>

AGENCY ONLINE DOCUMENTS: <http://www.globtek.info/certs/GT-83083-USB-W2Z/>

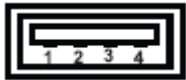

Pin 1: (+), Pin 2: Connected to Pin 3, Pin 3: Connected to Pin 2, Pin 4: (-); P2 and P3 are shorted together inside Power supply

GlobTek, Inc. www.globtek.com 186 Veterans Drive, Northvale, NJ 07647 Tel. (201) 784-1000 Fax (201) 784-0111	Drawing Title: GT-83083-0505-USB-W2, ITE Power Supply, Efficiency Level: VI, Case Color/Style: White C-62, Wall Plug-in, AC/DC Switching Adapter with USB Power Supply AC Adaptor, Input Rating: 100-240V- , 50/60Hz, N. America NEMA 1-15 Fixed , Output Rating: 5W, 5V@1A, Output Configuration: N/A mm, N/A/4 Cond, N/A, Type "A" USB "JACK", integral to power supply enclosure, Ferrite: None, N/A, GT Cord # C0132, Pin Out: Pin 1: (+), Pin 2: Connected to Pin 3, Pin 3: Connected to Pin 2, Pin 4: (-); P2 and P3 are shorted together inside Power supply, Blades/Input Cord: Fixed Blades North American 1-15P, Approvals: Double Insulation Level VI PSE RoHS VCCI WEEE LPS cULus CB	
	Model No. GT-83083-0505-USB-W2	
	Part No./Ordering No. WR9HA1000USB-F(R6W)	Rev G

PACKAGING

Packing Spec P/N: Standard with USB Jack, Individually Box

Box Qty: 360

Gift Box Size (mm): 42(L)*28(W)*72(H)

Gift Box Color: White

Master Carton Size (mm): 432*350*233

Master GW (Kg): 29.0 kg

BLADES INCLUDED: FBNA2:

BLADE/CORD INSTALLED: FBNA2:

If specific packaging is required, this section must specify all requirements and note "no exceptions". If this section does not specify packaging, it is subject to change without notice at GlobTek's discretion

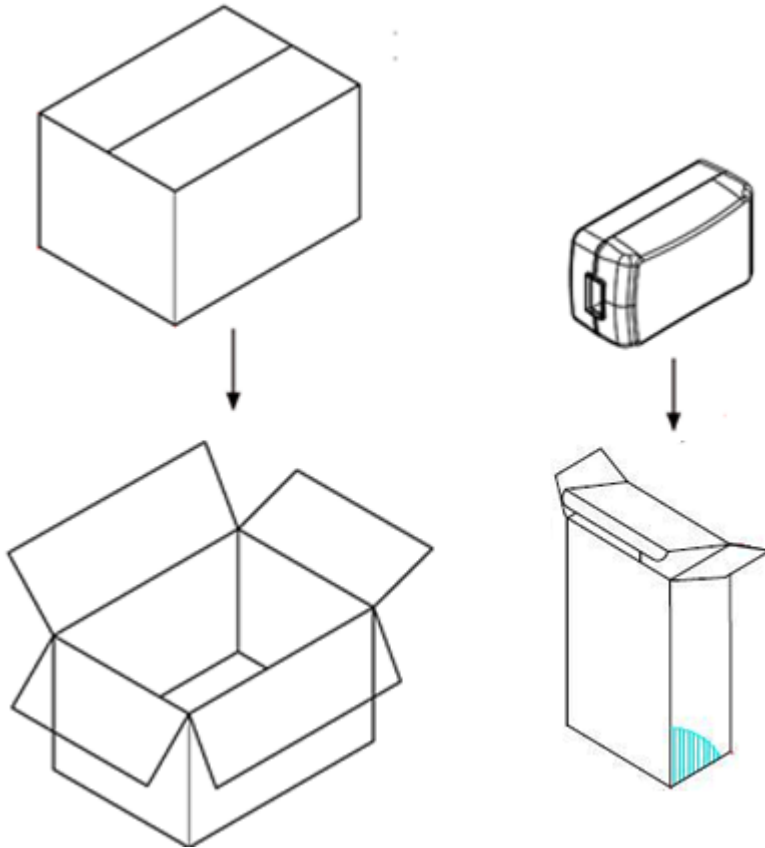

GlobTek, Inc. www.globtek.com 186 Veterans Drive, Northvale, NJ 07647 Tel. (201) 784-1000 Fax (201) 784-0111	Drawing Title: GT-83083-0505-USB-W2, ITE Power Supply, Efficiency Level: VI, Case Color/Style: White C-62, Wall Plug-in, AC/DC Switching Adapter with USB Power Supply AC Adaptor, Input Rating: 100-240V- , 50/60Hz, N. America NEMA 1-15 Fixed , Output Rating: 5W, 5V@1A, Output Configuration: N/A mm, N/A/4 Cond, N/A, Type "A" USB "JACK", integral to power supply enclosure, Ferrite: None, N/A, GT Cord # C0132, Pin Out: Pin 1: (+), Pin 2: Connected to Pin 3, Pin 3: Connected to Pin 2, Pin 4: (-); P2 and P3 are shorted together inside Power supply, Blades/Input Cord: Fixed Blades North American 1-15P, Approvals: Double Insulation Level VI PSE RoHS VCCI WEEE LPS cULus CB	
	Model No. GT-83083-0505-USB-W2	
	Part No./Ordering No. WR9HA1000USB-F(R6W)	Rev G

INSTRUCTION SHEET

N/A