

Excellent Detection of Color Differences**Ordering Information, Ratings, and Specifications****Amplifiers**

Item	Model	E3S-X3CE4 Sturdy model
Appearance		
Light source (wave length)		Red LED (660 nm)
Power supply voltage		12 to 24 VDC $\pm 10\%$
Current consumption		50 mA max.
Response time		Operate or reset: 1 ms max.
Control output		Output current: 1.5 to 4 mA, Load current: 80 mA max. (residual voltage: 2 V max.)
Operation indicator		Light indicator (red), Stability indicator (green)
Ambient illumination		Sunlight: 10,000 lx max.; Incandescent lamp: 3,000 lx max.
Ambient temperature		Operating: -25°C to 55°C (with no icing) Storage: -25°C to 70°C
Ambient humidity		Operating: 35% to 85% Storage: 35% to 95%
Insulation resistance		20 M Ω min. (at 500 VDC) between current-carrying parts and case
Dielectric strength		500 VAC at 50/60 Hz for 1 minute between current-carrying parts and case
Degree of protection		IEC IP66
Material		Case: Zinc die-cast

Fiber Units

Through-beam and Grooved-type Sensors

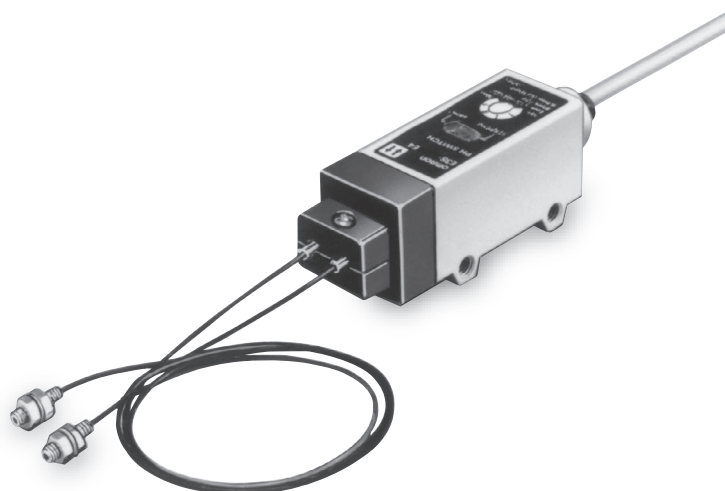
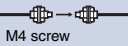
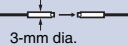
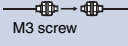
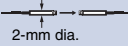
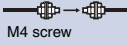
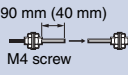



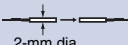
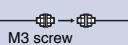
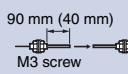
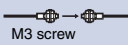
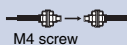
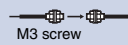



Sensing method Feature		Through-beam					
		Long distance				General-purpose	
		Model	E32-T11L	E32-T12L	E32-T21L	E32-T22L	E32-TC200
Appearance		 M4 screw	 3-mm dia.	 M3 screw	 2-mm dia.	 M4 screw	 90 mm (40 mm) M4 screw (): E32-TC200B4
Item							
With E3S- X3CE4	Sensing distance (standard sensing object)	250 (650) mm * Opaque: 1.4-mm dia. min.	250 mm Opaque: 1.4-mm dia. min.	65 mm Opaque: 0.9-mm dia. min.		120 mm (1 m) * Opaque: 1-mm dia. min.	120 mm Opaque: 1-mm dia. min.
	Minimum sensing object (copper strand) (typical)	0.3-mm dia.	0.2-mm dia.				
Ambient operating temperature		-40 to 70°C					
Ambient operating humidity		35% to 85%					
Permissible bending radius		25 mm min.					
Fiber sheath materials		Black polyethylene					

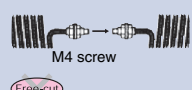

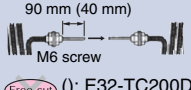



* Values in parentheses: when using the E39-F1 Lens Unit

Sensing method Feature		Through-beam					
		General-purpose			Attachment for E39-F5	Flexible (resists breaking)	
		Model	E32-T22	E32-TC200E	E32-TC200F E32-TC200F4	E32-TC200A	E32-T11
Appearance		 2-mm dia.	 M3 screw	 90 mm (40 mm) M3 screw (): E32-TC200F4	 M3 screw	 M4 screw	 M3 screw
Item							
With E3S- X3CE4	Sensing distance (standard sensing object)	35 mm Opaque: 0.5-mm dia. min.			120 mm Opaque: 1-mm dia. min.	120 mm (1 m) * Opaque: 1-mm dia. min.	35 mm Opaque: 0.5-mm dia. min.
	Minimum sensing object (copper strand) (typical)	0.1-mm dia.			0.2-mm dia.		0.1-mm dia.
Ambient operating temperature		-40 to 70°C					
Ambient operating humidity		35% to 85%					
Permissible bending radius		25 mm min.				4 mm min.	
Fiber sheath materials		Black polyethylene				Vinyl chloride	

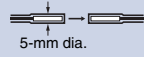
* Values in parentheses: when using the E39-F1 Lens Unit

 : Indicates models that do not allow free cutting.

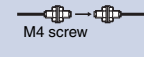
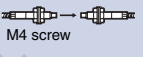
Item	Sensing method	Through-beam		Side-view Through-beam			Through-beam with lens
	Feature	Curl cable		Long distance	Space saving	Screw-mounting type	Suitable for explosion-proof applications
	Model	E32-TC200C	E32-TC200D E32-TC200D4	E32-T14L	E32-T24	E32-T14	E32-T17L
	Appearance	 M4 screw 	 90 mm (40 mm) M6 screw  (): E32-TC200D4	 3-mm dia.	 1-mm dia.		 M14 screw
With E3S-X3CE4	Sensing distance (standard sensing object)	100 (600) mm *1 Opaque: 1-mm dia. min.	100 mm Opaque: 1-mm dia. min.	80 mm Opaque: 1-mm dia. min.	30 mm Opaque: 0.5-mm dia. min.	600 mm Opaque: 4-mm dia. min.	5,000 mm Opaque: 10-mm dia. min.
	Minimum sensing object (copper strand) (typical)	0.2-mm dia.		0.1-mm dia.		0.8-mm dia.	
Ambient operating temperature		-40 to 70°C					
Ambient operating humidity		35% to 85%					
Permissible bending radius		25 mm min.					
Fiber sheath materials		Black polyethylene					

Item	Sensing method	Fluorocarbon polymer-covered through-beam	Screen through-beam	Four-head through-beam	Heat-resistant through-beam		Groove type
	Feature	Withstands chemicals and harsh environments	Suitable for detecting over a 10-mm area	Simultaneous detection in four locations	Heat resistant up to 150°C	Heat resistant up to 300°C	No optical axis adjustment required
	Model	E32-T12F	E32-T16	E32-M21	E32-T51	E32-T61	E32-G14
	Appearance	 5-mm dia.		 M3 screw 	 M4 screw	 M4 screw 	
With E3S-X3CE4	Sensing distance (standard sensing object)	550 mm Opaque: 4-mm dia. min.	550 mm *2 (Field of view: 10 mm width) Opaque: 10-mm dia. min.	100 mm Opaque: 2-mm dia. min.	120 mm Opaque: 1-mm dia. min.	100 mm Opaque: 1.5-mm dia. min.	100 mm (groove width) Opaque: 4-mm dia. min.
	Minimum sensing object (copper strand) (typical)	0.9-mm dia.	0.4-mm dia. *2	0.3-mm dia.	0.1-mm dia.		0.8-mm dia.
Ambient operating temperature		-30 to 70°C	-40 to 70°C	-40 to 150°C *3		-40 to 300°C	-40 to 70°C
Ambient operating humidity		35% to 85%					
Permissible bending radius		40 mm min.	25 mm min.	35 mm min.	25 mm min.		
Fiber sheath materials		Black polyethylene covered with fluorocarbon polymer	Black polyethylene	Fluororesin	SUS		Black polyethylene

*1. When using the E39-F1 Lens Unit. Ambient operating temperature specification is the same as the Lens Unit (-40 to 200°C).



*2. The sensing distance is 400 mm when a 1.0-mm-wide Slit is attached. The minimum diameter of the sensing object is 0.35 mm. The sensing distance is 300 mm when a 0.5-mm-wide Slit is attached. The minimum diameter of the sensing object is 0.25 mm. (Use a Slit with 0.5-mm width if the sensing distance is less than 300 mm. The measurements of distances are shown in the figure on the right.)

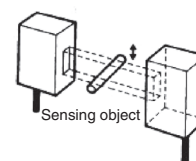



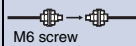
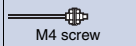
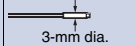

*3. For continuous operation, use the products within the temperature ranging from -40°C to 130°C.

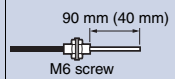
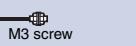

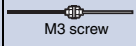
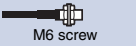
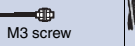
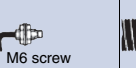

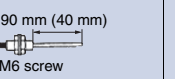

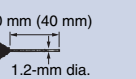

Reflective Sensors

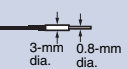

 : Indicates models that do not allow free cutting.

Sensing method Feature		Reflective					
		Long distance			General-purpose		
		Model	E32-D11L	E32-D21L	E32-D22L	E32-DC200	E32-DC200B E32-DC200B4
Item	Appearance	 M6 screw	 M4 screw	 3-mm dia.	 M6 screw	 90 mm (40 mm) M6 screw (): E32-TC200B4	 M3 screw
With E3S- X3CE4	Sensing distance (standard sensing object)	65 mm (white paper 3 x 3 cm)	18 mm (white paper 1.5 x 1.5 cm)		50 mm (white paper 3 x 3 cm)		12 mm (white paper 1.5 x 1.5 cm)
	Minimum sensing object (copper strand) (typical)	0.015-mm dia.	0.03-mm dia.				
Differential travel		20% of sensing distance max.					
Ambient operating temperature		-40 to 70°C					
Ambient operating humidity		35% to 85%					
Permissible bending radius		25 mm min.					
Fiber sheath materials		Black polyethylene					

Sensing method Feature		Reflective					
		General-purpose	Flexible (resists breaking)		Expandable curl cable	Sleeve adjustment	
		Model	E32-DC200F E32-DC200F4	E32-D11	E32-D21	E32-DC200C	E32-DC200D E32-DC200D4
Item	Appearance	 M3 screw	 M6 screw	 M3 screw	 M6 screw 	 90 mm (40 mm) M6 screw  (): E32-DC200D4	 90 mm (40 mm) 1.2-mm dia.  (): E32-DC9G4
With E3S- X3CE4	Sensing distance (standard sensing object)	12 mm (white paper 1.5 x 1.5 cm)	30 mm (white paper 3 x 3 cm)	7 mm (white paper 1.5 x 1.5 cm)	15 mm (white paper 3 x 3 cm)	20 mm (white paper 1.5 x 1.5 cm)	
	Minimum sensing object (copper strand) (typical)	0.03-mm dia.					
Differential travel		20% of sensing distance max.					
Ambient operating temperature		-40 to 70°C					
Ambient operating humidity		35% to 85%					
Permissible bending radius		25 mm min.	4 mm min.		25 mm min.		
Fiber sheath materials		Black polyethylene	Vinyl chloride		Black polyethylene		

 : Indicates models that do not allow free cutting.

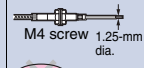
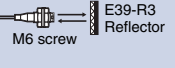
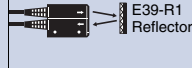
Sensing method		Superfine reflector	Coaxial reflective		Side-view reflective		Reflective covered with fluorocarbon polymer	Heat-resisting reflective
		Minute object sensing	Positioning accuracy		Long distance	Space saving	Withstands chemicals and harsh environments	Heat resistant to 150°C
Model		E32-D33	E32-CC200	E32-D32	E3-D14L	E32-D24	E32-D12F	E32-D51
Appearance								
Item	Sensing distance (standard sensing object)	4 mm (white paper 1.5 x 1.5 cm)	50 mm (white paper 3 x 3 cm)	20 mm (white paper 3 x 3 cm)	25 mm (white paper 3 x 3 cm)	10 mm (white paper 1.5 x 1.5 cm)	35 mm (white paper 3 x 3 cm)	40 mm (white paper 3 x 3 cm)
	Minimum sensing object (copper strand) (typical)	0.015-mm dia.	0.03-mm dia.					
Differential travel		20% of sensing distance max.						
Ambient operating temperature		-40 to 70°C					-30 to 70°C	-40 to 150°C ^{*1}
Ambient operating humidity		35% to 85%						
Permissible bending radius		25 mm min.					40 mm min.	35 mm min.
Fiber sheath materials		Black polyethylene					Black polyethylene covered with fluorocarbon polymer	Fluororesin

Sensing method		Heat-resistant reflective		Retro-reflective (with MSR function)		Convergent-reflective	
		Heat resistant up to 300°C	Heat resistant up to 400°C	Transparent object detection		Detects wafers and small differences in height	
Model		E32-D61	E32-D73	E32-R21+E39-R3 ^{*4}	E32-R16+E39-R1 ^{*4}	E32-L25 ^{*3}	E32-L25A ^{*3}
Appearance							
Item	Sensing distance (standard sensing object)	30 mm (white paper 3 x 3 cm)		30 to 200 mm (with E39-R3 Reflector, Opaque: 35-mm dia. min.)	100 to 1,200 mm (with E39-R1 Reflector, Opaque: 35-mm dia. min.) ^{*2}	3.3 mm white paper 3 x 3 cm)	
	Minimum sensing object (copper strand) (typical)	0.03-mm dia.		0.3-mm dia.	0.6-mm dia.	0.025-mm dia.	
Differential travel		---				5% max. of sensing distance	
Ambient operating temperature		-40 to 300°C	-40 to 400°C	-40 to 70°C	-25 to 55°C	-40 to 70°C	
Ambient operating humidity		35% to 85%					
Permissible bending radius		25 mm min.					
Fiber sheath materials		SUS		Black polyethylene			

*1. For continuous operation, use the products within the temperature ranging from -40°C to 130°C.

*2. The sensing distance is 30 to 80 mm for the E39-RSA with a Tape-type Reflector, and 30 to 120 mm for the E39-RSB.

*3. Refer to *Dimensions* on pages 24 and 25 for the standards for sensing distances.

*4. The ambient operating temperature specification of the Reflectors is the same as that of the E32-R21 and E32-R16.



Fiber Unit Specifications

Ambient operating temperature	No icing or condensation
Ambient operating humidity	No condensation
Ambient storage temperature	Heat-resistant Fiber Units: -40 to 110°C (with no icing or condensation) Other Fiber Units: -40 to 70°C (with no icing or condensation)
Ambient storage humidity	35% to 95% (with no icing or condensation)
Vibration resistance (destruction)	10 to 55 Hz, 1.5-mm double amplitude for 2 hours each in X, Y, and Z directions
Shock resistance (destruction)	500 m/s ² (50G) for 3 times each in X, Y, and Z directions

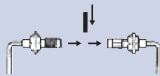
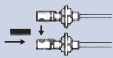
Attachments

Name		Small Spot Lens Unit	Long-distance Lens Unit			Side-view Unit		
		Detection over 0.5-mm-dia. spots	Increasing sensing distance			Change detection direction to side view		
Model		E39-F3A	E39-F1			E39-F2		
Sensing method		Reflective 	Through-beam 			Through-beam 		
Item								
Applicable fibers		E32-D32	E32-T11L	E32-TC200 E32-T11	E32-TC200C E32-T61	E32-T11L	E32-TC200 E32-T11	E32-TC200C E32-T61
With E3S-X3CE4	Sensing distance	6 to 12 mm	650 mm	1,000 mm	600 mm	100 mm	120 mm	100 mm
	Standard sensing object	White paper 3 x 3 mm	Opaque: 4-mm dia. min.			Opaque: 3-mm dia. min.		
Directional angle		---	5 to 40°			20 to 60°		
Differential travel		20% max. of sensing distance	---					
Ambient temperature		-40 to 70°C	-40 to 200°C *					
Material	Shaft	Aluminum	Brass					
	Lens	Optical glass						

* Use the Fiber Unit within the specified ambient operating temperature range specified for it. If the Fiber Unit is used with the E32-T61, make sure the ambient temperature is -40 to 200°C.

Item	Name	Lens-equipped Reflective Unit					Side-view Reflective Unit
	Applications	Converting through-beam sensors to long distance reflective sensors					Converting through-beam to reflective sensor
	Model	E39-F3					E39-F5
	Sensing method	Reflective 					Reflective 
Applicable fibers		E32-T11L	E32-TC200	E32-T61	E32-T11	E32-TC200C	E32-TC200A
With E3S-X3CE4	Sensing distance	5 to 90 mm	35 to 50 mm			20 mm (5 x 5 cm)	
	Standard sensing object (white paper)	20 x 20 cm	1.5 x 1.5 cm				
Directivity		20% max. of sensing distance					
Differential travel		-40 to 200°C *					-40 to 70°C
Material	Shaft	Brass					---
	Lens	Optical glass					---
	Base	Aluminum					Brass
	Reflector	---					Stainless steel

* Use the Fiber Unit within the specified ambient operating temperature range specified for it. If the Fiber Unit is used with the E32-T61, make sure the ambient temperature is -40 to 200°C.

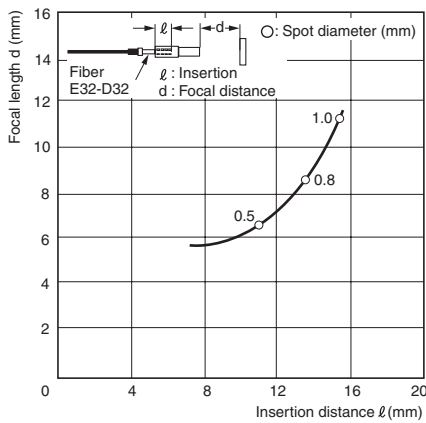

Beam Spot Characteristics

E39-F3A with E32-D32

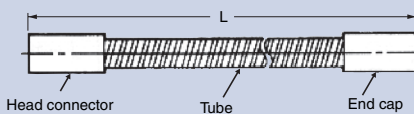

Name	Protective Spiral Tubes							
	500 mm	1,000 mm	500 mm	1,000 mm	500 mm	1,000 mm	500 mm	1,000 mm
Length (L)	E39-F32A5	E39-F32A	E39-F32B5	E39-F32B	E39-F32C5	E39-F32C	E39-F32D5	E39-F32D
Model								
Appearance	* Refer to page 13 for information on attaching the end cap.							
Item	E32-DC200E E32-DC200F(4) E32-D21		E32-TC200E E32-TC200F(4) E32-T21 E32-T21L		E32-TC200 E32-TC200B(4) E32-T11 E32-T51 E32-T11L		E32-DC200 E32-DC200B(4) E32-CC200 E32-D11 E32-D51 E32-D11L	
Applicable fiber	-40°C to 150°C (Do not exceed the operating temperature of the fiber)							
Ambient operating temperature	35% to 85%							
Ambient operating humidity	30 mm min.							
Permissible bending radius	Between head connector and end cap with tube: 1.5 N-m max. Tube: 2 N-m max.							
Tensile strength	Tube: 29.4 N max.							
Compression load								

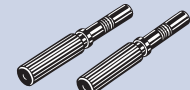
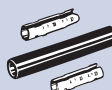
Accessories

Name	Fiber Cutter	Fine-fiber Attachment	Fiber Connector	Sleeve Bender
Features	Used to cut fibers to desired lengths	Used when inserting fine fibers into the amp	Used to connect additional fibers for extension	Used to bend fiber sleeves
Model	E39-F4	E39-F9	E39-F10	E39-F11
Appearance				
Item	E32-DC200E, -TC200E E32-DC200F(4), -TC200F(4) E32-D21, -D21L, -D22L, E32-T21, -T21L, -T22L, E32-D32, -T22 E32-D24, -T24 E32-D33 E32-R21		E32-DC200, -TC200 E32-DC200B(4), -TC200B(4) E32-TC200A E32-T14, -G14 E32-D11L, -T11L, -T12L E32-D14L, -T14L E32-T17L	
Applicable fiber	All models equipped with fibers that can be trimmed.		E32-TC200B(4) E32-TC200D(4) E32-DC200F(4), -TC200F(4) E32-DC9G(4)	
Provided/Order separately	Provided with Fiber Units.		Order separately.	

Engineering Data (Typical)

Fiber Length vs. Sensing Distance

Through-beam Fiber Units
(Fiber length of 2 m corresponds to 100%)

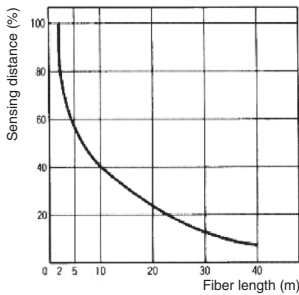

Fiber Units with Reflective Sensors
(Fiber length of 2 m corresponds to 100%)

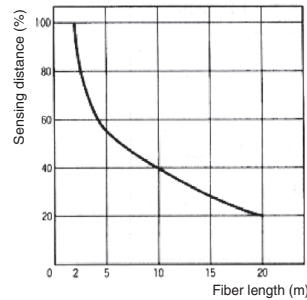

E3X-N□□□□, E32-TC200
(Change in rated value)

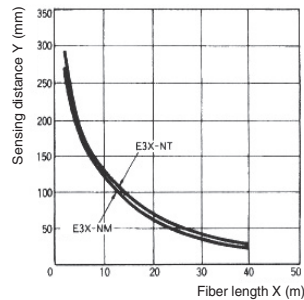

E3X-N□□□□, E32-DC200
(Change in rated value)

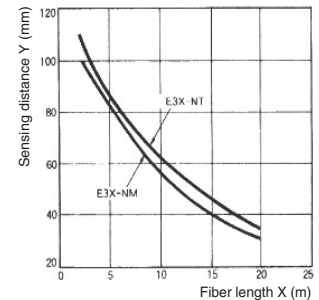

I/O Circuit Diagrams

Conductor colors have been changed as a result of changes in standards. The previous colors are given in brackets.

Item	Model	E3S-X3CE4			
	Wire color	Brown (red) *1	Blue (black) *1	Brown (red) *1	Blue (black) *1
Power polarity		+	0 V	0 V	+
State of output transistor		Light-ON		Dark-ON	
Output circuit	<p>Z: Zener Diode (Vz = 30 V)</p>				
Timing charts	<p>Incident light</p> <p>No incident light</p> <p>Light indicator (red) ON</p> <p>Output transistor ON</p> <p>Load 1 (e.g., relay) Operate</p> <p>Reset</p> <p>H Between brown (red) and black (white)</p> <p>L Between blue (black) and black (white)</p>		<p>Incident light</p> <p>No incident light</p> <p>Light indicator (red) OFF</p> <p>Output transistor OFF</p> <p>Load 1 (e.g., relay) Operate</p> <p>Reset</p> <p>H Between blue (black) and black (white)</p> <p>L Between brown (red) and black (white)</p>		

Note: Not equipped with load short-circuit protection function.
*1. Reverse the polarity of the power supply to switch the output status.
*2. Voltage output (when connected to a transistor circuit)

Connection

Conductor colors have been changed as a result of changes in standards. The previous colors are given in brackets.

● Connection with S3D2 Sensor Controller

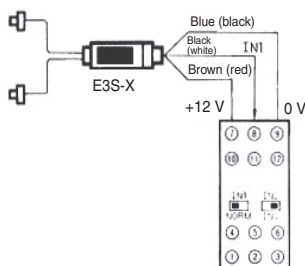

Note: A maximum of two S3D2 Sensors can be connected.

● Connection with S3D8 Sensor Controller

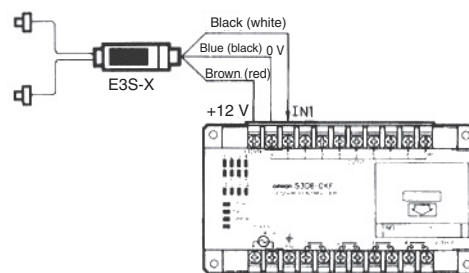





















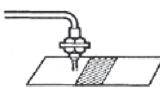

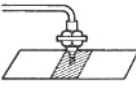
Note 1. Operation can be reversed using the -Key.
2. A maximum of eight S3D2 Sensors can be connected.

Adjustment Methods

Sensitivity Adjustment

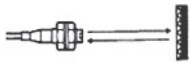
Adjust the sensitivity so that the indicators appear as shown in the following table during various sensing situations.

Type		Sensing condition	Light status	Indicator status
Through-beam		 Sensing object present	Interrupted	  Green Red Red indicator: OFF Green indicator: ON
		 No sensing object	Incident	  Green Red Red indicator: ON Green indicator: ON
Reflective	Sensing object	 Sensing object present	Incident	  Green Red Red indicator: ON Green indicator: ON
		 No sensing object	Interrupted	  Green Red Red indicator: OFF Green indicator: ON
	Detection of differences in color or brightness	 Color with good reflection	Incident	  Green Red Red indicator: ON Green indicator: ON
		 Color with bad reflection	Interrupted	  Green Red Red indicator: OFF Green indicator: ON
Retro-reflective		 Sensing object present Reflector	Interrupted	  Green Red Red indicator: OFF Green indicator: ON
		 Sensing object present Reflector	Incident	  Green Red Red indicator: ON Green indicator: ON

Note 1. When the sensitivity is set to achieve the above status, the Sensor will operate stably at all temperatures within the range specified in the ratings.
 2. Even if the green indicator turns OFF, if the temperature change is less than $\pm 10^{\circ}\text{C}$ from when the setting was made, operation will remain stable.

Safety Precautions

WARNING

This product is not designed or rated for ensuring safety of persons. Do not use it for such purpose.



Precautions for Correct Use

Do not use the product in atmospheres or environments that exceed product ratings.

Fiber Units

● **Fiber Units**

Heat-resistant Fiber Units (E32-D51 and E32-T51)

- Make sure that the bending radius 35 mm or greater.
- The fibers of these Units cannot be extended using the E39-F10 Fiber Connector.
- The maximum allowable temperature for continuous operation with these Units is 130°C. It is 150°C for short-term use.

E32-T14 and E32-G14

These Units may enter the light-ON state if there are reflecting objects at the ends of the lenses. In this case, attach the black stickers provided to the ends of the lenses.

**E32-T14
E32-G14**

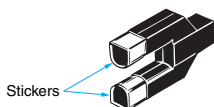

E32-L25(A) Wafer Sensors

- To ensure correct performance, insert the fiber with a white line into the emitter-side port of the Amplifier.
- Use a tightening torque of 0.78 N·m when mounting the Sensor head.
- Do not use the Sensor in locations subject to splashing water.

E39-F11 Sleeve Bender

- The bending radius of the stainless steel tube should be as large as possible. The smaller the bending radius becomes, the shorter the sensing distance will be.
- Insert the tip of the stainless steel tube to the Sleeve Bender and bend the stainless steel tube slowly along the curve of the Sleeve Bender.

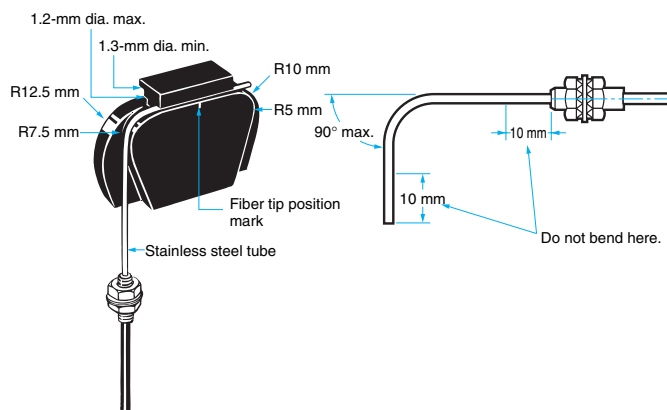

E32-T16 Slit

If a Slit is going to be used, remove the back paper and stick it on the Sensor head so that the edges are aligned. For a sensing distance of less than 45 cm, fit the Sensor head with a 0.5-mm-wide Slit.

Example

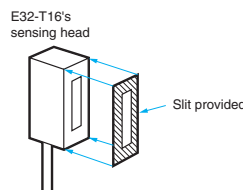

● **Tightening Torque**

- The tightening force applied to the Fiber Unit should be as follows:

Screw-mounting Sensor

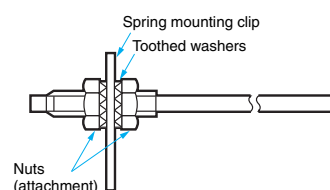

Cylindrical Sensor

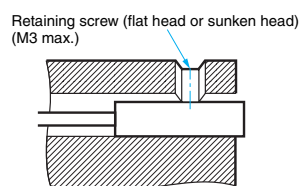

Fiber Units	Tightening torque
M3/M4 screw	0.78 N·m max.
M6 screw	0.98 N·m max.
2-mm-dia./3-mm-dia. cylinder	0.29 N·m max.
E32-D14L	0.98 N·m max.
E32-T12F E32-D12F	0.78 N·m max.
E32-T16	0.49 N·m max.
E32-R21	0.59 N·m max.
E32-M21	Up to 5 mm to the tip: 0.49 N·m max. More than 5 mm from the tip: 0.78 N·m max.
E32-L25A	0.78 N·m max.

- Use a proper-sized spanner.



● Cutting Fiber

- Insert a fiber into the Fiber Cutter and determine the length of the fiber to be cut.
- Press down the Fiber Cutter in a single stroke to cut the fiber.

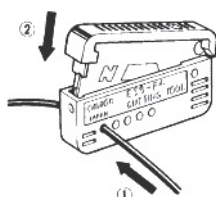

- The cutting holes cannot be used twice. If the same hole is used twice, the cutting face of the fiber will be rough and the sensing distance will be reduced. Always use an unused hole.
- Use either one of the two holes on the right (refer to the following figure) to cut a thin fiber as follows:

1	An attachment is temporarily fitted to a thin fiber before shipment.	
2	Secure the attachment after adjusting the position of it in the direction indicated by the arrow.	
3	Insert the fiber into the E39-F4 to cut.	
4	Finished state (proper cutting state).	

● Fiber Insertion Position

When the Fiber Unit is pressed in, it will first hit the rubber packing. Keep pressing it in further until it contacts the back surface.

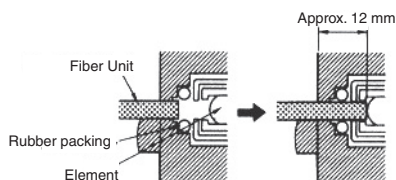

● Securing the Fiber

Tighten the screw to 0.2 N·m with a screwdriver.

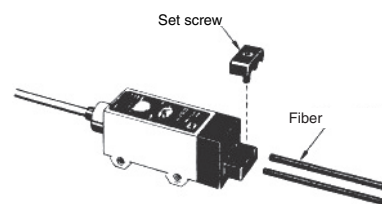

● Laying the Fiber Unit

- Do not pull or press on the Fiber Units. The Fiber Units have a withstand force of 9.8 N or 29.4 N maximum.
- Do not bend the Fiber Unit beyond the permissible bending radius given under Ordering Information.
- Do not bend the edge of the Fiber Units.

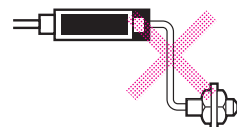
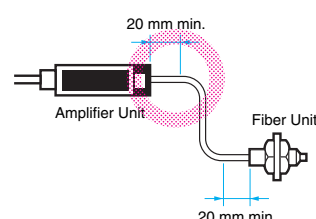

- Do not apply excess force on the Fiber Units.

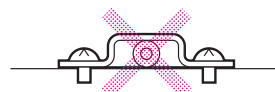
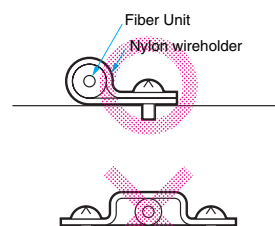

- The Fiber Head could be broken by excessive vibration. To prevent this, the following is effective:

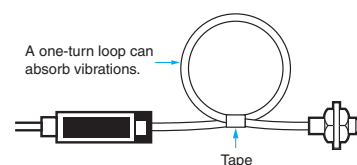

Attachment Units

● **Applications**

E39-F10 Fiber Connector

- Use the following procedure to connect fibers via the Fiber Connector.

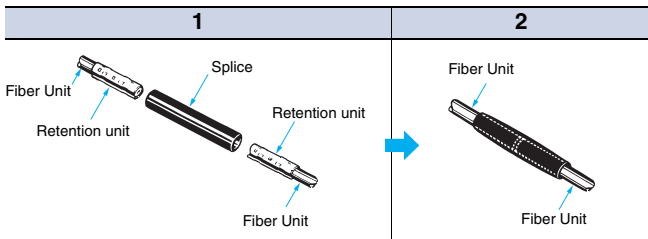

- Each Fiber Unit should be as close as possible before they are connected.
- Sensing distance will be reduced by approximately 25% when fibers are connected.
- Only fibers with a 2.2-mm dia. can be connected.

E39-F32 Protective Spiral Tube

- Insert a fiber to the Protective Spiral Tube from the head connector side (screwed) of the tube.

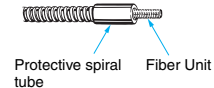

- Push the fiber into the Protective Spiral Tube. The tube should be straight so that the fiber is not twisted when inserted. Then turn the end cap of the spiral tube.

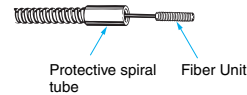

- Secure the Protective Spiral Tube on a suitable place with the attached nut.

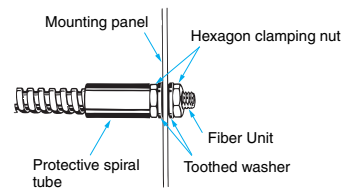

- Use the attached saddle to secure the end cap of the Protective Spiral Tube. To secure the Protective Spiral Tube at a position other than the end cap, apply tape to the tube so that the portion becomes thicker in diameter.

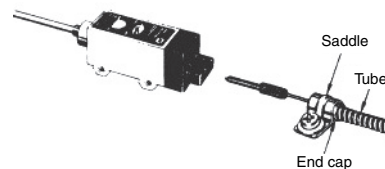

Fiber Customization Service

OMRON provides the following items to support Fiber Units.
For information on available models, delivery, and prices, contact your OMRON sales representative.

Stainless Tubes at Various Lengths

● **Applicable Fiber Units**

- E32-TC200F (0.9-mm-dia. tube)
- E32-TC200B
- E32-DC200F (1.2-mm-dia. tube)
- E32-DC200B (2.5-mm-dia. tube)



Can be made at lengths between 10 and 120 mm in increments of 10 mm.

Tolerance: For $L \leq 40$ mm = ± 1.0 mm
For $L > 40$ mm = ± 2.0 mm
(Lengths of 90 mm and 40 mm are standard sizes.)

Stainless Tubes with a Bent End

● **Applicable Fiber Units**

- E32-TC200B
- E32-TC200F
- E32-DC200F

● **Available Bending Radius (R) and Dimensions L1, L2**
(Units: mm)

R	Control No.	L1		L2		Total length of SUS tube S□
		1	2	3	4	
R5.0	A	10	15	5	10	120 max.
R7.5	B	12.5	17.5	7.5	17.5	120 max.
R10.0	C	15	20	10	20	120 max.
R12.5	D	17.5	22.5	12.5	22.5	120 max.

Note: Tubes cannot be made to dimensions other than those listed above.
An E39-F11 Sleeve Bender (sold separately) can be used to achieve dimensions other than those given above.

Bend at the tip of the tube

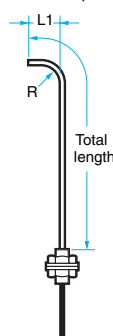

Bend at the base of the tube

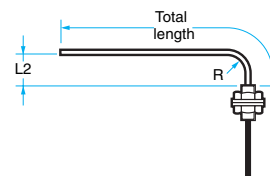

● **Model Numbers Incorporating the Bending Radius, R, and Dimensions L1 and L2**

Specifying L1 Only (Units: mm)

Bending radius	L1 (±1)	Model
R5	10	E32-[*1]C200[*2]-S[*3]A1
	15	E32-[*1]C200[*2]-S[*3]A2
R7.5	12.5	E32-[*1]C200[*2]-S[*3]B1
	17.5	E32-[*1]C200[*2]-S[*3]B2
R10	15	E32-[*1]C200[*2]-S[*3]C1
	20	E32-[*1]C200[*2]-S[*3]C2
R12.5	17.5	E32-[*1]C200[*2]-S[*3]D1
	22.5	E32-[*1]C200[*2]-S[*3]D2

- *1. Insert "T" for Through-beam Fiber Units and "D" for Fiber Units with Reflective Sensors.
- *2. Insert the "B" or "F" that appears at the end of the original model number.
- *3. Insert "50" if the total length is 50 mm. The total length must not exceed 120 mm.

Specify L2 only (Units: mm)

Bending radius	L2 (±1)	Model
R5	5	E32-[*1]C200[*2]-S[*3]A3
	10	E32-[*1]C200[*2]-S[*3]A4
R7.5	7.5	E32-[*1]C200[*2]-S[*3]B3
	17.5	E32-[*1]C200[*2]-S[*3]B4
R10	10	E32-[*1]C200[*2]-S[*3]C3
	20	E32-[*1]C200[*2]-S[*3]C4
R12.5	12.5	E32-[*1]C200[*2]-S[*3]D3
	22.5	E32-[*1]C200[*2]-S[*3]D4

- *1. Insert "T" for Through-beam Fiber Units and "D" for Fiber Units with Reflective Sensors.
- *2. Insert the "B" or "F" that appears at the end of the original model number.
- *3. Insert "50" if the total length is 50 mm. The total length must not exceed 120 mm.

Specifying L1 and L2 (Units: mm)

Bending radius	L1 (±1)	L2 (±1)	Model
R5	10	5	E32-[*1]C200[*2]-A13
	10	10	E32-[*1]C200[*2]-A14
	15	5	E32-[*1]C200[*2]-A23
	15	10	E32-[*1]C200[*2]-A24
R7.5	12.5	7.5	E32-[*1]C200[*2]-B13
	12.5	17.5	E32-[*1]C200[*2]-B14
	17.5	7.5	E32-[*1]C200[*2]-B23
	17.5	17.5	E32-[*1]C200[*2]-B24
R10	15	10	E32-[*1]C200[*2]-C13
	15	20	E32-[*1]C200[*2]-C14
	20	10	E32-[*1]C200[*2]-C23
	20	20	E32-[*1]C200[*2]-C24
R12.5	17.5	12.5	E32-[*1]C200[*2]-D13
	17.5	22.5	E32-[*1]C200[*2]-D14
	22.5	12.5	E32-[*1]C200[*2]-D23
	22.5	22.5	E32-[*1]C200[*2]-D24

- *1. Insert "T" for Through-beam Fiber Units and "D" for Fiber Units with Reflective Sensor.s
- *2. Insert the "B" or "F" that appears at the end of the original model numbers.

● Sensing Distance

(Units: mm)

Model	Amplifier	Standard product	R5.0	R7.5	R10.0	R12.5
E32-TC200B	E3X-NT	290	180	235	255	290
	E3X-NM	270	170	220	240	270
E32-TC200F	E3X-NT	70	32	70		
	E3X-NM	65	30	65		
E32-DC200F	E3X-NT	22	16	22		
	E3X-NM	20	15	20		

Long-fiber Fiber Units

● Applicable Fiber Units (Typical Models)

E32-TC200/-DC200

E32-TC200B/-DC200B

E32-TC200E/-DC200E

E32-TC200F/-DC200F

E32-TC200A



Between 6 and 20 m in increments of 1 m
(Lengths of 2 m and 5 m are standard sizes
(E32-TC200/-DC200 only).)

Dimensions

Unless otherwise specified, the tolerance class IT16 is used for dimensions in this data sheet.

Amplifiers

E3S-X3CE4

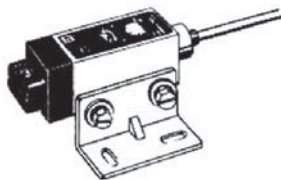

Cable:
4.3C x 0.2-mm-dia. (18/0.12 dia.)
vinyl-insulated round cable
Standard length: 2 m

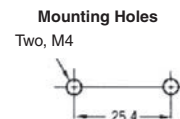
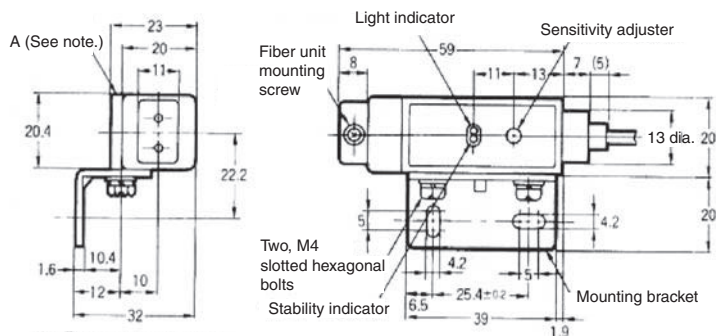

Note: The Mounting Bracket can also be used on side A.

Through-beam Fiber Units (Two Units are used together as a set.)

E32-T11L

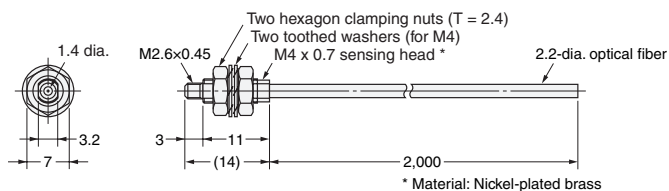

E32-T12L

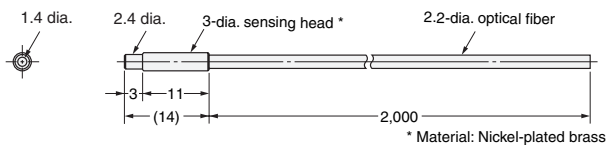

E32-T21L

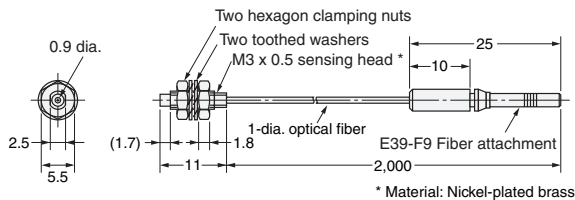

E32-T22L

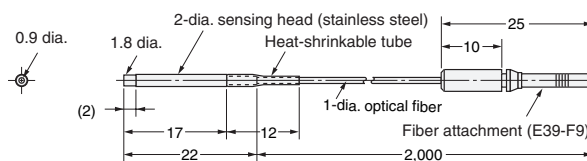

E32-TC200

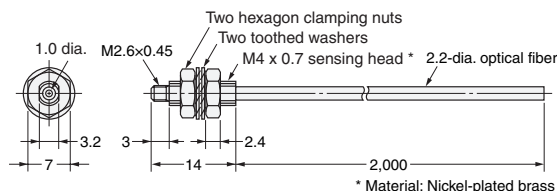

E32-TC200B
E32-TC200B4

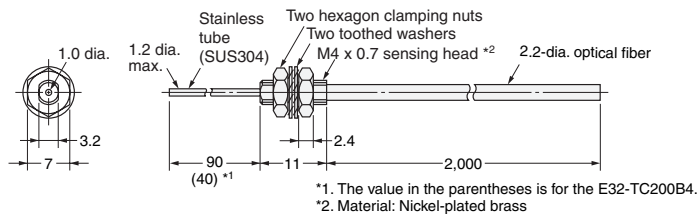

E32-T22

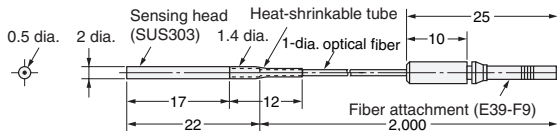

E32-TC200E

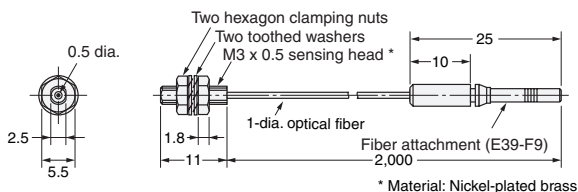

E32-TC200F
E32-TC200F4

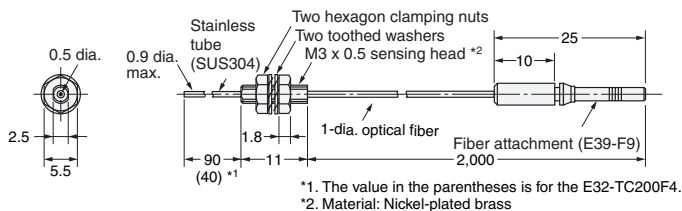

E32-T200A

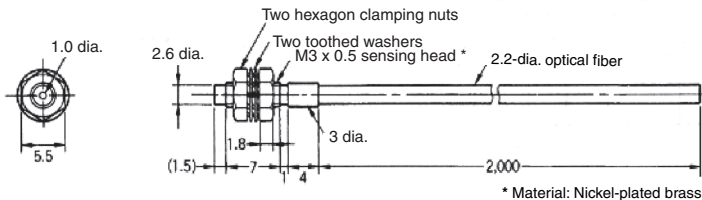

E32-T11

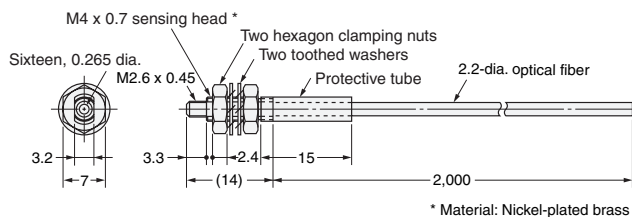

E32-T21

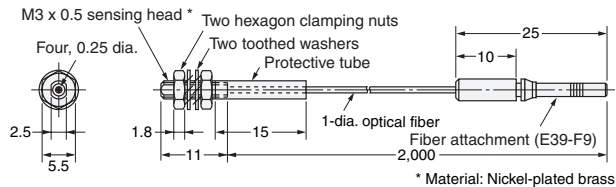

 : Indicates models that do not allow free cutting.

E32-TC200C

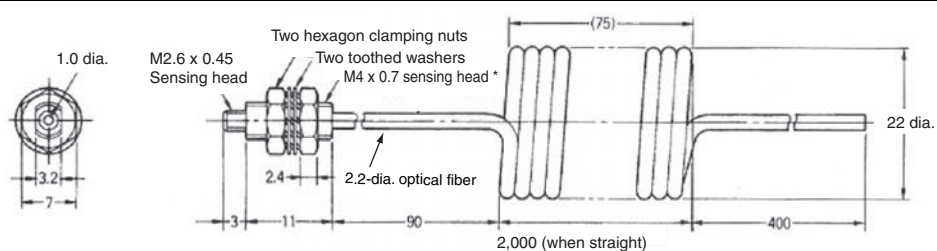

* Material: Nickel-plated brass

E32-TC200D E32-TC200D4

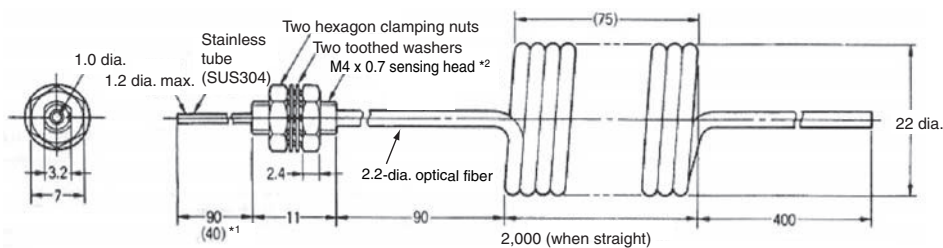

*1. The value in the parentheses is for the E32-TC200D4.
*2. Material: Nickel-plated brass

E32-T14L

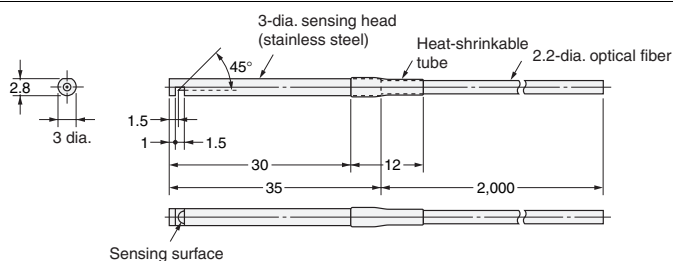

E32-T24

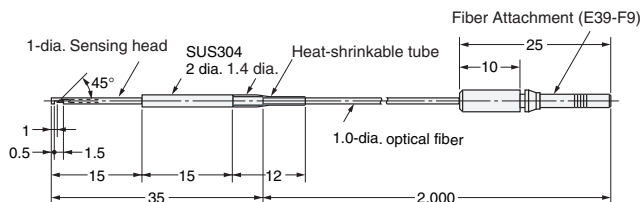

E32-T14

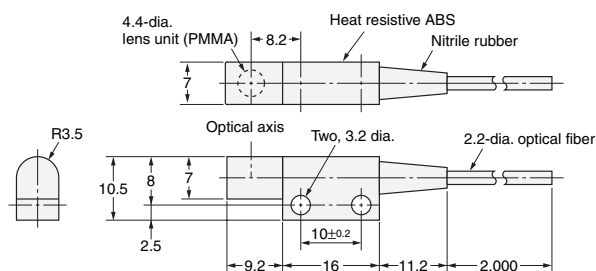

E32-T17L

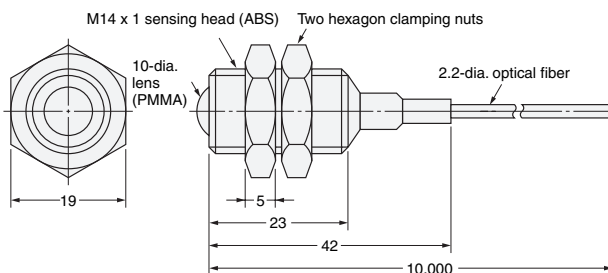

 : Indicates models that do not allow free cutting.

E32-T12F

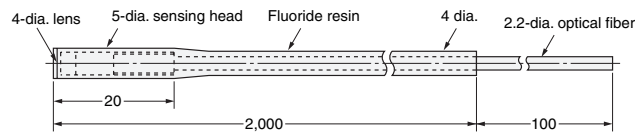

E32-T16

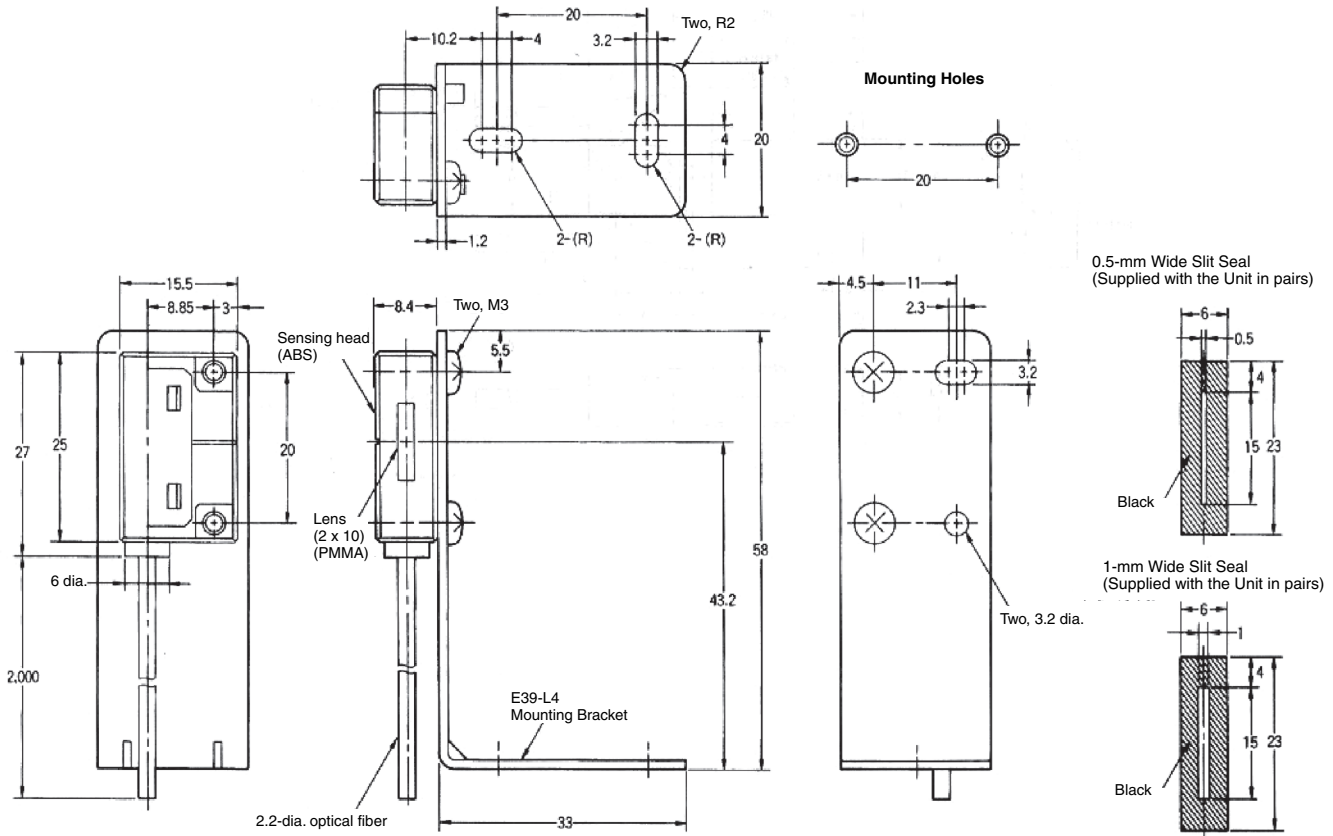

E32-M21

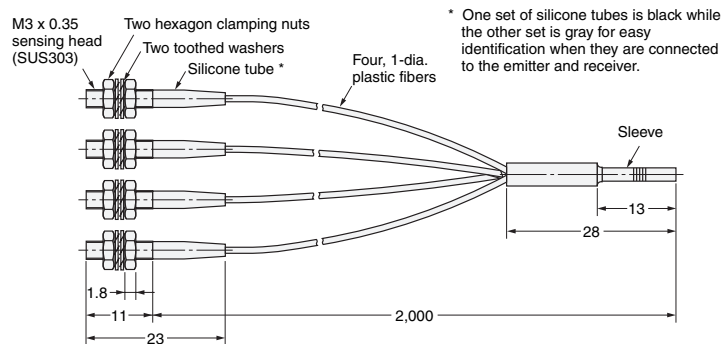

E32-T51

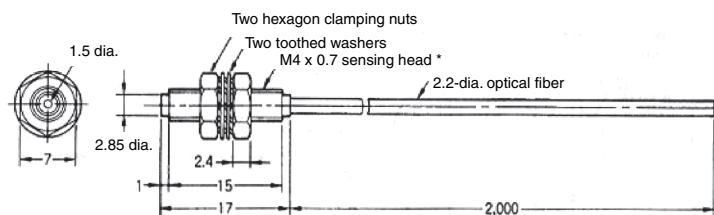

* Material: Nickel-plated brass

Note: Resistant temperature is 150°C.
Resistant temperature is 130°C when used continuously.

 : Indicates models that do not allow free cutting.

E32-T61

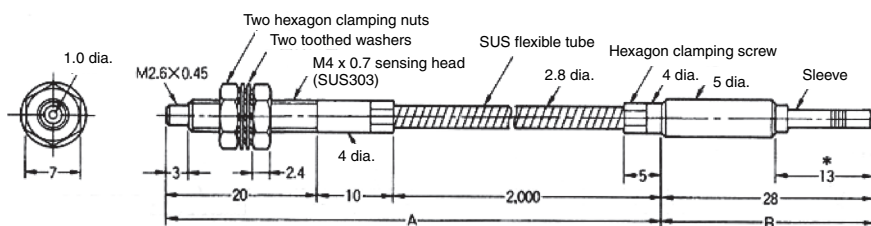

Note:
 Section A resists 300°C and section B (which is inserted to the Amplifier) resists 110°C.
 The operating temperature of the section to be inserted (marked with *) must be within the operating temperature range of the Amplifier.

E32-G14

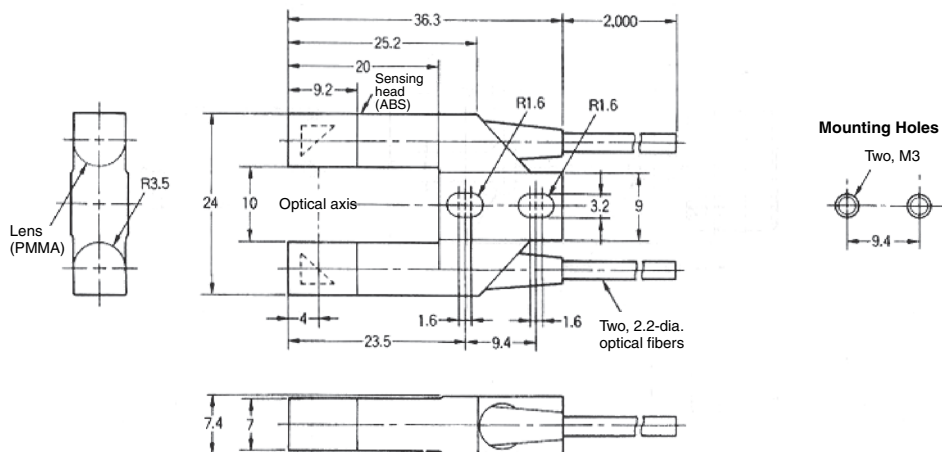

Reflective Fiber Units

E32-D11L

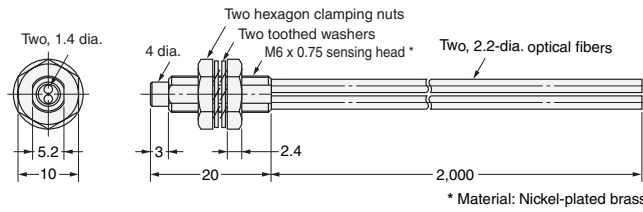

E32-D21L

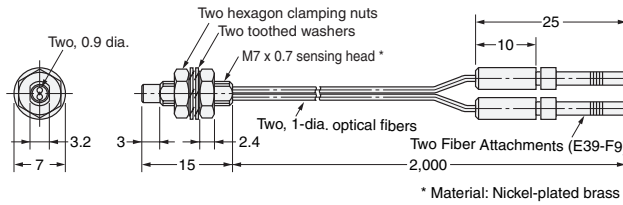

E32-D22L

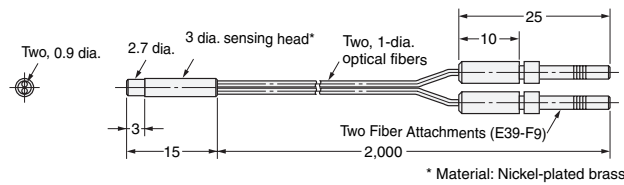

E32-DC200

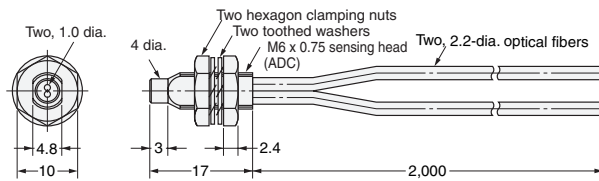

E32-DC200B
E32-DC200B4

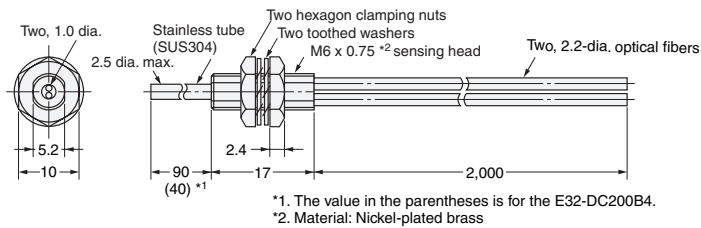

E32-DC200E

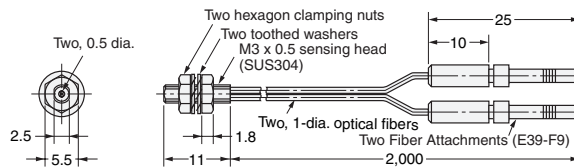

E32-DC200F
E32-DC200F4

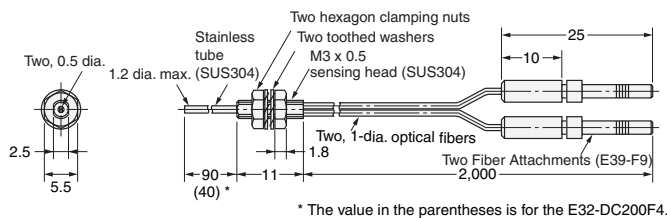

 : Indicates models that do not allow free cutting.

E32-D11

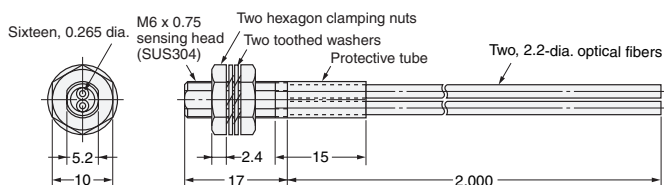

E32-D21

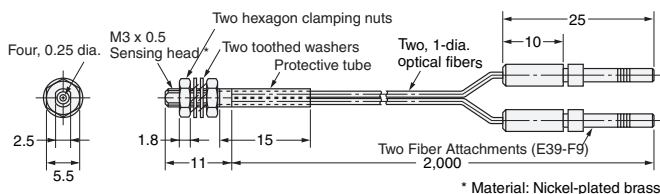

E32-DC200C

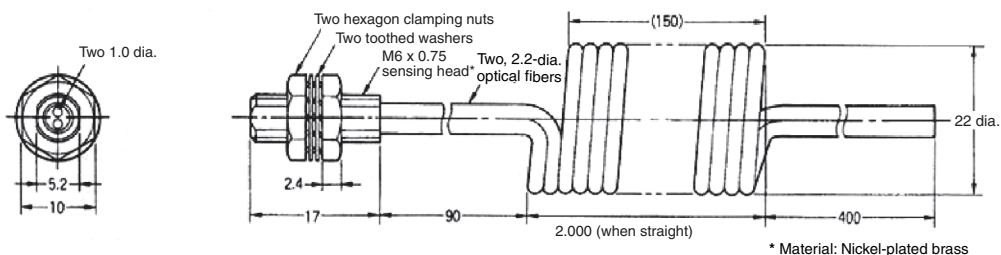

E32-DC200D E32-DC200D4

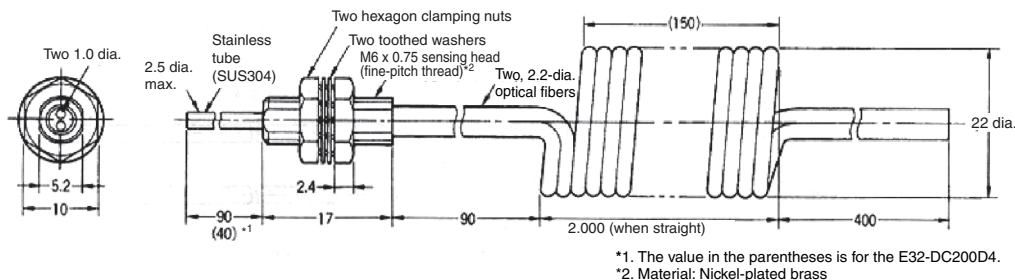

E32-DC9G E32-DC9G4

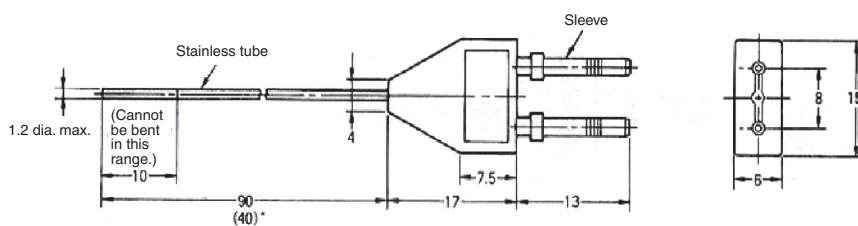

E32-D33

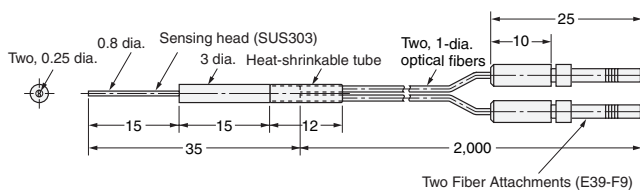

E32-CC200

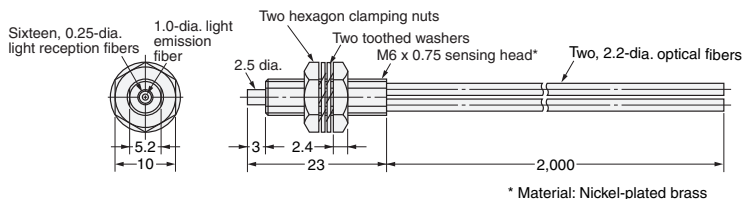

Note: The fiber for the emitter is identified by a white line.

 : Indicates models that do not allow free cutting.

E32-D32

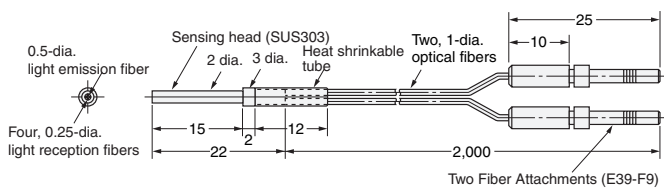

E32-D14L

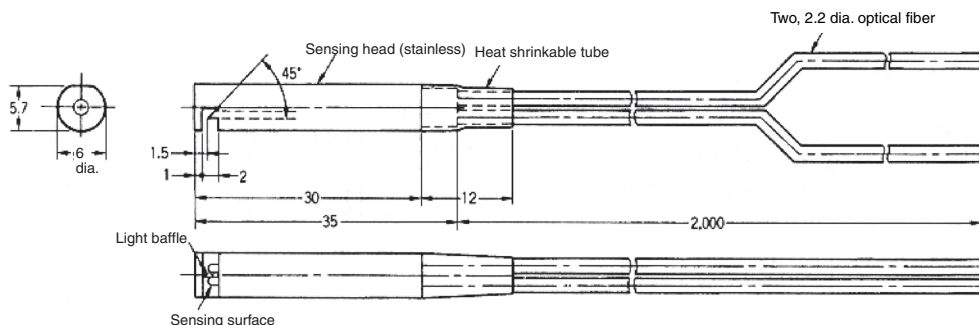

E32-D24

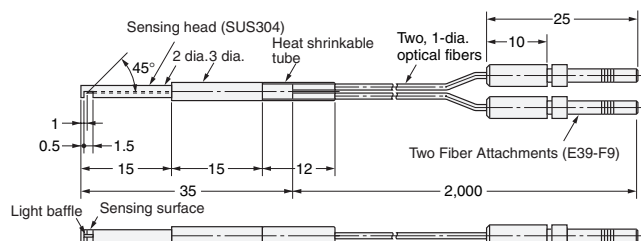

E32-D12F

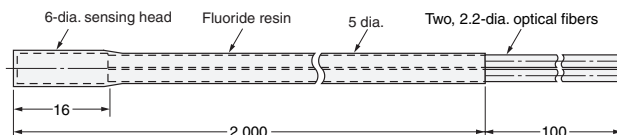

E32-D51

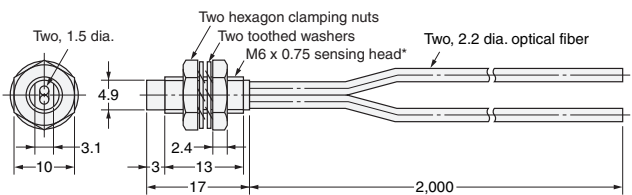

* Material: Nickel-plated brass
 Note: Resistant temperature is 150°C.
 Resistant temperature is 130°C when used continuously.

E32-D61



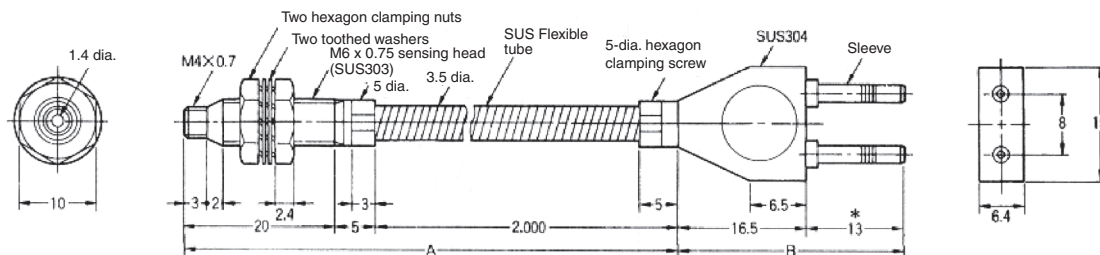

Note: Section A resists 300°C and section B (which is inserted to the Amplifier) resists 110°C. The operating temperature of the section to be inserted (marked with *) must be within the operating temperature range of the Amplifier.

 : Indicates models that do not allow free cutting.

E32-D73

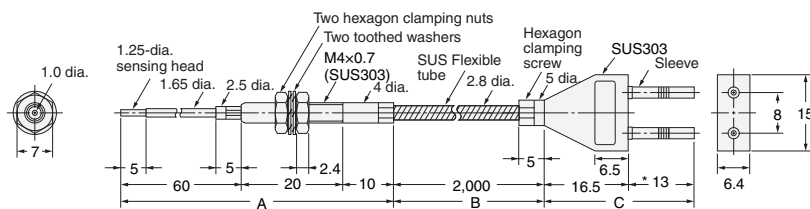

Note:
Section A resists 400°C, section B resists 300°C, and section C (which is inserted to the Amplifier) resists 110°C. The operating temperature of the section to be inserted (marked with *) must be within the operating temperature range of the Amplifier.

E32-R21

(One E39-R3 Reflector is supplied with the Sensor.)

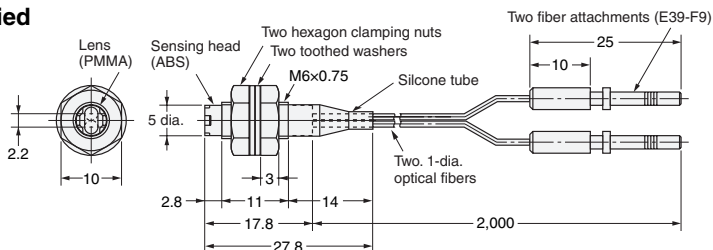

E32-R16

(One E39-R1 Reflector is supplied with the Sensor.)

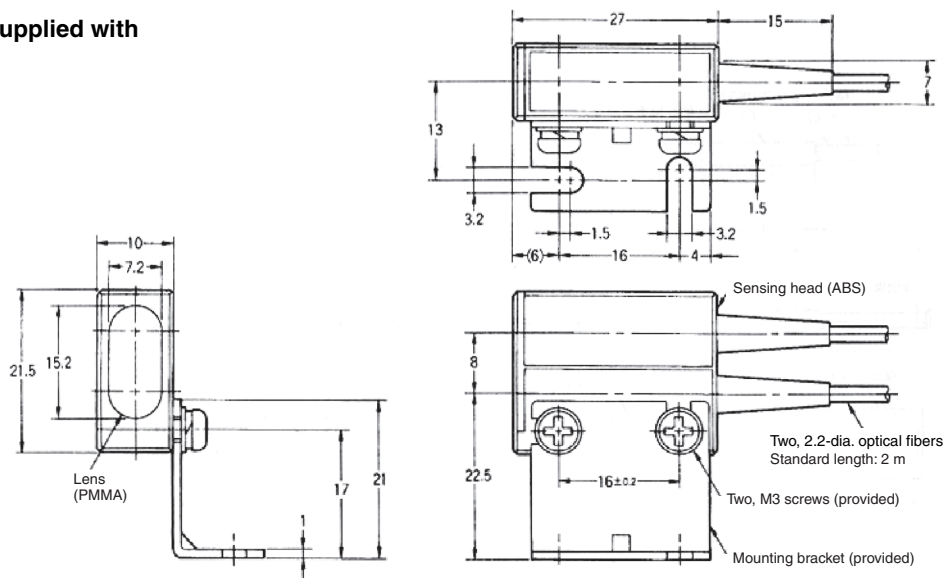

E32-L25

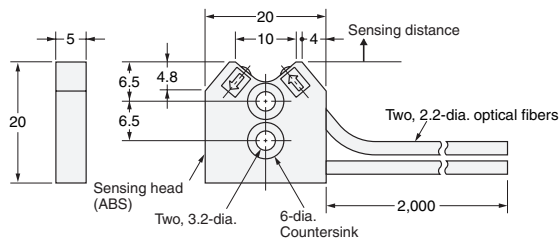

Note:
The fiber for the emitter is identified by a white line.

E32-L25A

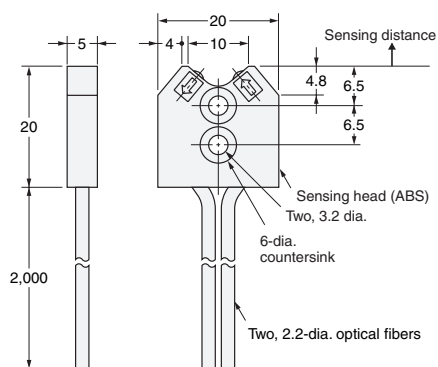

Note:
The fiber for the emitter is identified by a white line.

Reflectors

Miniature Reflector
E39-R3 (Supplied with E32-R21)



Note: Mounting bracket is attached.

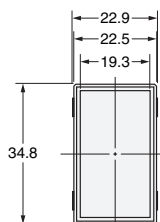

Material:
Reflective surface: Acrylic
Rear surface: ABS

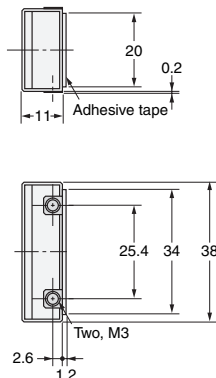

Reflector
E39-R1 (Supplied with E32-R16)



Material:
Reflective surface: Acrylic
Rear surface: ABS

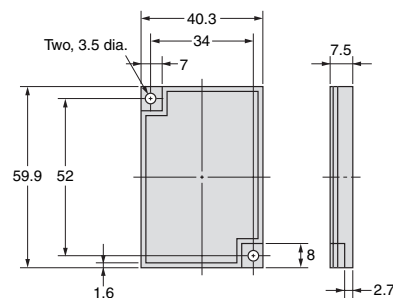

Attachments

(Order separately)

E39-F1
Lens Unit

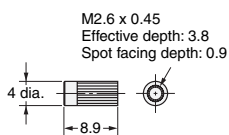

Note: One set includes two units.

E39-F2
Side-view Unit

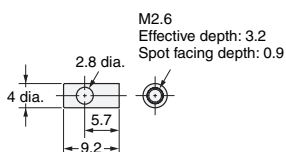

Note: One set includes two units.

E39-F2 Lens-equipped Reflective Unit

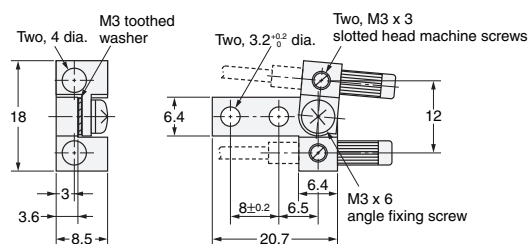

E39-F5 Side-view Reflective Unit

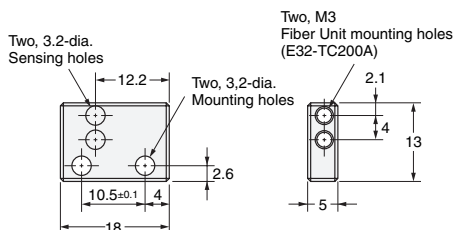

Note:
When mounting, remove all of the accompanying screws first and then screw the E32-TC200A into the E39-F5 until the stopper comes into contact.

E39-F3A Small Spot Lens Unit

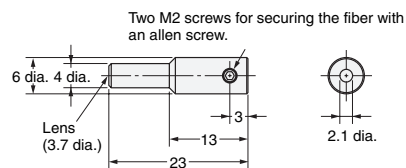
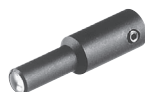

Note: This Lens Unit is for the E32-D32.

Protective Spiral Tubes (Order Separately)

E39-F32A, -F32A5
E39-F32B, -F32B5

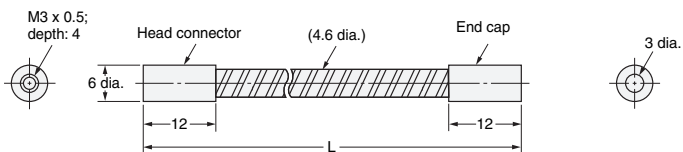
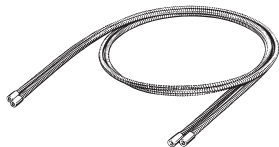

Note:
1. The length L is 1,000 for the E39-F32A/-F32B and 500 for the E39-F32A5/-F32B5.
2. The E39-F32B(5) consists of two E39-F32A(5)s.

E39-F32C, -F32C5

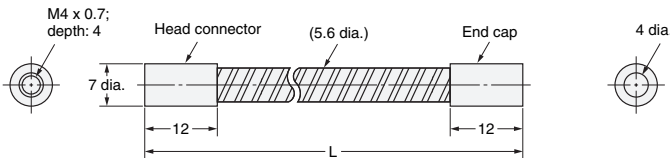
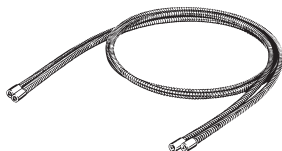

Note: The length L is 1,000 for the E39-F32C and 500 for the E39-F32C5.

E39-F32D, -F32D5

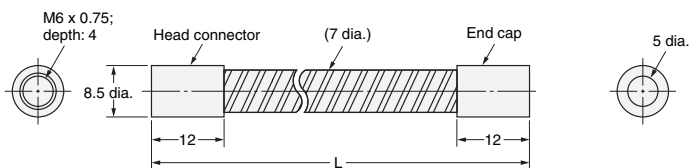
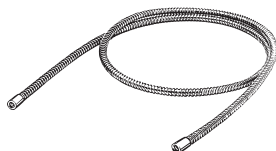

Note: The length L is 1,000 for the E39-F32D and 500 for the E39-F32D5.

Accessories

Fiber Cutter (Provided)
E39-F4

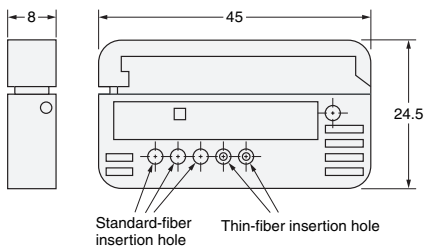
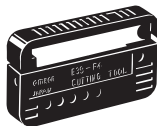

Thin-fiber Attachments
E39-F9



Note: Two per set.

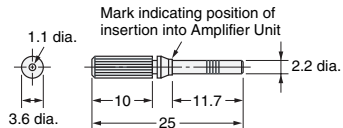

Fiber Connector (Order Separately)
E39-F10

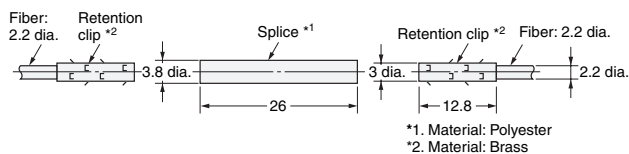

*1. Material: Polyester
*2. Material: Brass

In the interest of product improvement, specifications are subject to change without notice.

Read and Understand This Catalog

Please read and understand this catalog before purchasing the products. Please consult your OMRON representative if you have any questions or comments.

Warranty and Limitations of Liability

WARRANTY

OMRON's exclusive warranty is that the products are free from defects in materials and workmanship for a period of one year (or other period if specified) from date of sale by OMRON.

OMRON MAKES NO WARRANTY OR REPRESENTATION, EXPRESS OR IMPLIED, REGARDING NON-INFRINGEMENT, MERCHANTABILITY, OR FITNESS FOR PARTICULAR PURPOSE OF THE PRODUCTS. ANY BUYER OR USER ACKNOWLEDGES THAT THE BUYER OR USER ALONE HAS DETERMINED THAT THE PRODUCTS WILL SUITABLY MEET THE REQUIREMENTS OF THEIR INTENDED USE. OMRON DISCLAIMS ALL OTHER WARRANTIES, EXPRESS OR IMPLIED.

LIMITATIONS OF LIABILITY

OMRON SHALL NOT BE RESPONSIBLE FOR SPECIAL, INDIRECT, OR CONSEQUENTIAL DAMAGES, LOSS OF PROFITS OR COMMERCIAL LOSS IN ANY WAY CONNECTED WITH THE PRODUCTS, WHETHER SUCH CLAIM IS BASED ON CONTRACT, WARRANTY, NEGLIGENCE, OR STRICT LIABILITY.

In no event shall the responsibility of OMRON for any act exceed the individual price of the product on which liability is asserted.

IN NO EVENT SHALL OMRON BE RESPONSIBLE FOR WARRANTY, REPAIR, OR OTHER CLAIMS REGARDING THE PRODUCTS UNLESS OMRON'S ANALYSIS CONFIRMS THAT THE PRODUCTS WERE PROPERLY HANDLED, STORED, INSTALLED, AND MAINTAINED AND NOT SUBJECT TO CONTAMINATION, ABUSE, MISUSE, OR INAPPROPRIATE MODIFICATION OR REPAIR.

Application Considerations

SUITABILITY FOR USE

OMRON shall not be responsible for conformity with any standards, codes, or regulations that apply to the combination of products in the customer's application or use of the products.

At the customer's request, OMRON will provide applicable third party certification documents identifying ratings and limitations of use that apply to the products. This information by itself is not sufficient for a complete determination of the suitability of the products in combination with the end product, machine, system, or other application or use.

The following are some examples of applications for which particular attention must be given. This is not intended to be an exhaustive list of all possible uses of the products, nor is it intended to imply that the uses listed may be suitable for the products:

- Outdoor use, uses involving potential chemical contamination or electrical interference, or conditions or uses not described in this catalog.
- Nuclear energy control systems, combustion systems, railroad systems, aviation systems, medical equipment, amusement machines, vehicles, safety equipment, and installations subject to separate industry or government regulations.
- Systems, machines, and equipment that could present a risk to life or property.

Please know and observe all prohibitions of use applicable to the products.

NEVER USE THE PRODUCTS FOR AN APPLICATION INVOLVING SERIOUS RISK TO LIFE OR PROPERTY WITHOUT ENSURING THAT THE SYSTEM AS A WHOLE HAS BEEN DESIGNED TO ADDRESS THE RISKS, AND THAT THE OMRON PRODUCTS ARE PROPERLY RATED AND INSTALLED FOR THE INTENDED USE WITHIN THE OVERALL EQUIPMENT OR SYSTEM.

PROGRAMMABLE PRODUCTS

OMRON shall not be responsible for the user's programming of a programmable product, or any consequence thereof.

Disclaimers

CHANGE IN SPECIFICATIONS

Product specifications and accessories may be changed at any time based on improvements and other reasons.

It is our practice to change model numbers when published ratings or features are changed, or when significant construction changes are made. However, some specifications of the products may be changed without any notice. When in doubt, special model numbers may be assigned to fix or establish key specifications for your application on your request. Please consult with your OMRON representative at any time to confirm actual specifications of purchased products.

DIMENSIONS AND WEIGHTS

Dimensions and weights are nominal and are not to be used for manufacturing purposes, even when tolerances are shown.

PERFORMANCE DATA

Performance data given in this catalog is provided as a guide for the user in determining suitability and does not constitute a warranty. It may represent the result of OMRON's test conditions, and the users must correlate it to actual application requirements. Actual performance is subject to the OMRON Warranty and Limitations of Liability.

ERRORS AND OMISSIONS

The information in this document has been carefully checked and is believed to be accurate; however, no responsibility is assumed for clerical, typographical, or proofreading errors, or omissions.

2008.9

In the interest of product improvement, specifications are subject to change without notice.

OMRON Corporation
Industrial Automation Company

<http://www.ia.omron.com/>

(c)Copyright OMRON Corporation 2008 All Right Reserved.