

Extrusion

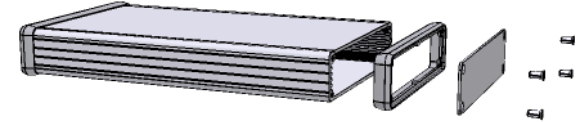

EXTRUSION DESIGNED FOR 120MM WIDE PC BOARD

Slot Details

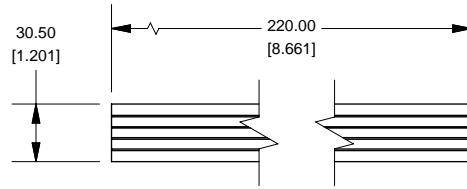
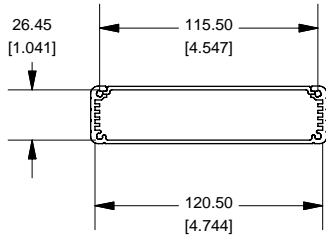
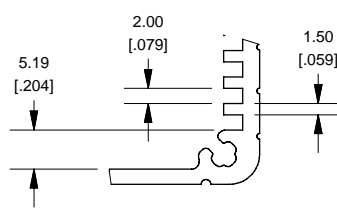

End Plate

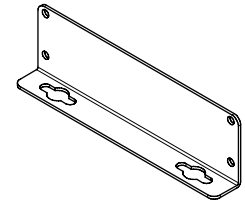
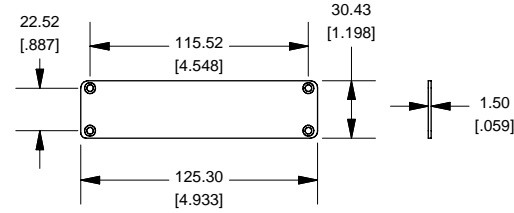

OPTIONAL FLANGE END PANELS 1455PF

Enclosures can be Factory Modified (Milling, Drilling, Printing etc.)
 Solid models of this enclosure available in STEP or IGES.
 Contact Factory mjm@hammondmfg.com

NOTE	
Purchased assembly includes box, plastic bezels, end panels, #6 Taptight screws and self adhesive rubber feet.	
Box made from Extruded Aluminum 6063.	
Bezels made with polycarbonate.	

1455P2201	
PART NUMBERS	
Clear Anodized	1455P2201
Black Anodized	1455P2201BK
ACCESSORIES	
See website for accessories.	

Open Bezel

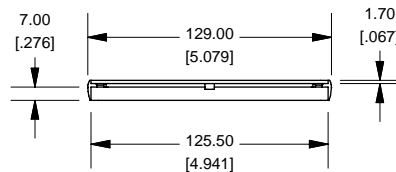
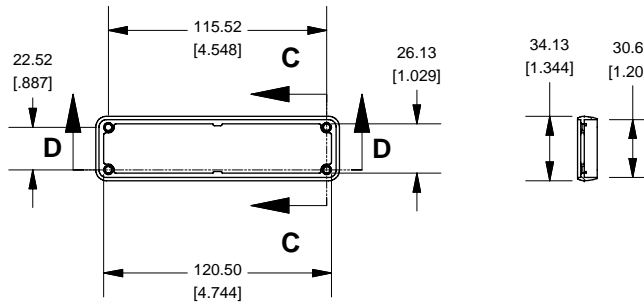

HAMMOND MANUFACTURING™
1455P2201
www.hammondmfg.com