

DFC10 Series

Single Output DC-DC Converters

The DFC10 Series provides power converter solutions to meet commercial and industrial requirements. With power densities above 11 watts per cubic inch (0.67 watts per cm³), overcurrent protection, and five-sided shielded case, the DFC10 meets the most rigorous needs in an industry-standard case size.

The 220 kHz operating frequency of the DFC10 Series allows an increased power density while including adequate heat sinking and input/output filtering.

This eliminates the need for external components in most applications. Full overload protection is provided by pulse-by-pulse current limiting.

Key Features & Benefits

- RoHS compliant
- High power density, up to 11 watts per cubic inch (0.67 watts per cm³)
- Efficiencies up to 83%
- Low input-to-output capacitance
- 700 V isolation (1544 V for 48 V converters)
- Continuous overcurrent protection
- 5-Sided, shielded copper case
- Extended input range (2:1)



bel POWER
SOLUTIONS &
PROTECTION

a bel group

belpowersolutions.com

1. MODEL SELECTION

MODEL	INPUT RANGE ⁴ [VDC]		OUTPUT [VDC]	OUTPUT [mA]
	MIN	MAX		
DFC10E12S5	9	18	5	2000
DFC10E12S12	9	18	12	900
DFC10E24S5	18	36	5	2000
DFC10E24S12	18	36	12	900
DFC10E24S15	18	36	15	700

Model numbers highlighted in yellow are not recommended for new designs.

2. GENERAL SPECIFICATIONS ¹ – ALL MODELS

PARAMETER	CONDITIONS / DESCRIPTION	MIN	TYP	MAX	UNITS
Isolation ²					
Isolation Voltage	Input to Output 12 V, 24 V	700			VDC
Leakage Current			10		μA
Capacitance	Input to Output		400		pF
Environmental					
Case Operating Range (T _c)	No Derating	-40		90	°C
Case Functional Range ³		-50		100	°C
Storage Range		-55		105	°C
Thermal Impedance ⁴			15		°C/W
General					
MTBF	Calculated		800000		hrs
Weight			1.0/28		oz/g
Chassis Mounting Kit	12 V, 24 V		CM2B2		

NOTES

- ¹ All parameters measured at T_c = 25°C, nominal input voltage and full rated load unless otherwise noted.
- ² The Case is tied to the -Input pin.
- ³ The functional temperature range is intended to give an additional data point for use in evaluating this power supply. At the low functional temperature the power supply will function with no side effects, however, sustained operation at the high functional temperature will reduce expected operational life. The data sheet specifications are not guaranteed beyond the case operating range.
- ⁴ The case thermal impedance is specified as the case temperature rise over ambient per package watt dissipated.

3. INPUT SPECIFICATIONS¹

PARAMETER	CONDITIONS / DESCRIPTION	MIN	TYP	MAX	UNITS
Reflected Ripple ²	DFC10E12S5 / DFC10E12S12		400		mA _{pp}
			145		mA _{rms}
	DFC10E24S5 / DFC10E24S12 / DFC10E24S15		210		mA _{pp}
			70		mA _{rms}
Input Current	Full Load / No Load	DFC10E12S5	1070 / 7		mA
		DFC10E12S12	1100 / 12		
		DFC10E24S5	500 / 7		
		DFC10E24S12	530 / 10		
		DFC10E24S15	510 / 10		
Efficiency		DFC10E12S5	78		%
		DFC10E12S12	82		
		DFC10E24S5	83		
		DFC10E24S12	85		
		DFC10E24S15	86		
Switching Frequency			220		kHz
Maximum Input Overvoltage, 100 ms maximum	DFC10E12S5 / DFC10E12S12			24	VDC
	DFC10E24S5 / DFC10E24S12 / DFC10E24S15			45	
Turn –on Time, 1% Output Error				10	ms

4. OUTPUT SPECIFICATIONS¹

PARAMETER	CONDITIONS / DESCRIPTION	MIN	TYP	MAX	UNITS
Output Voltage	DFC10E12S5 / DFC10E24S5		5		VDC
	DFC10E12S12 / DFC10E24S12		12		
	DFC10E24S15		15		
Output Voltage Accuracy	DFC10E12S5 / DFC10E24S5	4.95	5.00	5.05	VDC
	DFC10E12S12 / DFC10E24S12	11.90	12.00	12.10	
	DFC10E24S15	14.90	15.00	15.10	
Rated Load Range	DFC10E12S5 / DFC10E24S5			2.0	A
	DFC10E12S12 / DFC10E24S12	0.0		0.9	
	DFC10E24S15			0.7	
Load Regulation	25% Max Load - Max Load	DFC10E12S5 / DFC10E24S5	0.1	0.4	%
		DFC10E12S12 / DFC10E24S12	0.2		
		DFC10E24S15	0.2		
Line Regulation	Vin = Min – Max VDC	DFC10E12S5 / DFC10E24S5	0.01	0.2	%
		DFC10E12S12 / DFC10E24S12	0.2		
		DFC10E24S15	0.2		
Short Term Stability ³			< 0.05		% / 24 Hrs
Long Term Stability			< 0.1		% / kWhrs
Input Ripple Rejection ⁴			> 40		dB
Noise, Peak-Peak ²			60		mV _{pp}
RMS Noise			6		mV _{rms}
Temperature Coefficient			50	150	ppm / °C
Short Circuit Protection from +OUT to -OUT	Continuous, Current Limit Protection				

NOTES

- ¹ All parameters measured at Tc = 25°C, nominal input voltage and full rated load unless otherwise noted.
- ² Noise measurement bandwidth is 0-20 MHz for peak-peak measurements, 10 kHz to 1 MHz for RMS measurements. Output noise is measured with a 0.01µF / 100V ceramic capacitor in parallel with a 1µf / 35V Tantalum capacitor, 1 inch from the output pins to simulate standard PCB decoupling capacitance.
- ³ Short term stability is specified after a 30 minute warmup at full load, constant line and recording the drift over a 24 hour period.
- ⁴ The input ripple rejection is specified for DC to 120 Hz ripple with a modulation amplitude of 1% of Vin.

5. DFC10 SERIES APPLICATION NOTES

EXTERNAL CAPACITANCE REQUIREMENTS

No external capacitance is required for operation of the DFC10 Series. If a capacitive input source is farther than 1" from the converter, an additional capacitor may be required at the input pins for proper operation.

This input capacitor should have an ESR greater than 0.25 ohms. Input capacitors with an ESR less than 0.25 ohms may cause peaking of the input filter and actually degrade circuit performance.

External output capacitance is not required for operation. However, it is recommended that 1 μ F to 10 μ F of tantalum and 0.001 to 0.1 μ F ceramic capacitance be selected for reduced system noise. Additional output capacitance may be added for increased filtering, but should not exceed 400 μ F.

NEGATIVE OUTPUTS

A negative output voltage may be obtained by connecting the +OUT to circuit ground and connecting -OUT as the negative output.

12 VOLT INPUT MODELS

12 VOLT INPUT CURRENT Vs. LINE INPUT VOLTAGE

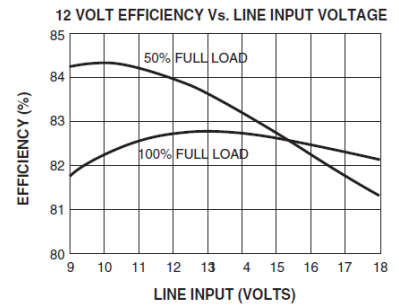
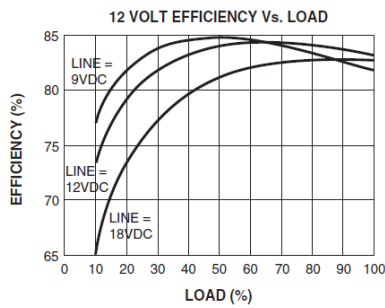
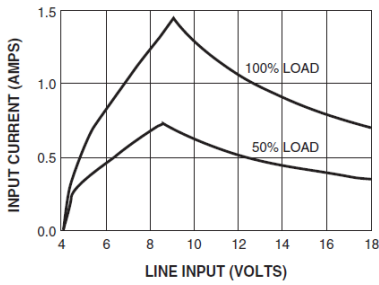

24 VOLT INPUT MODELS

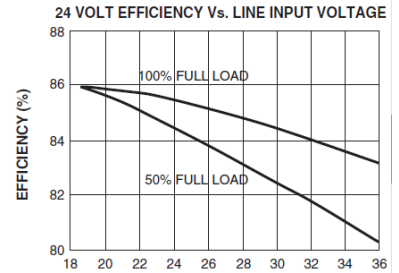
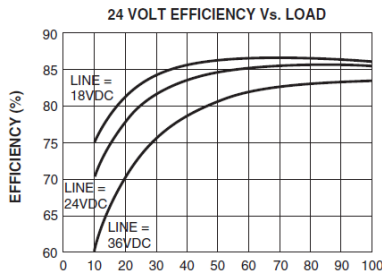
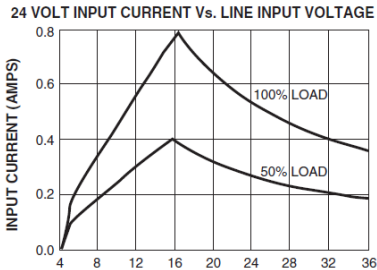

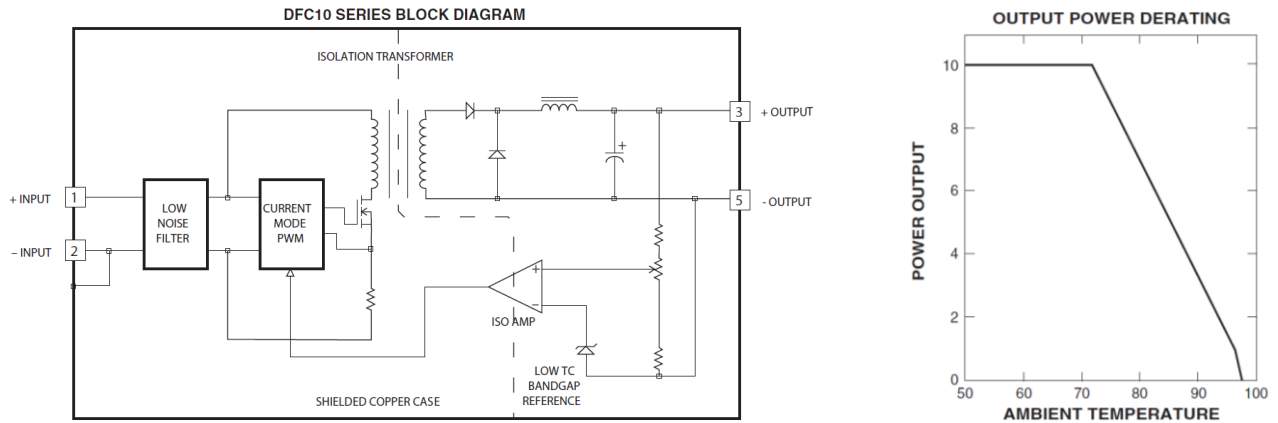
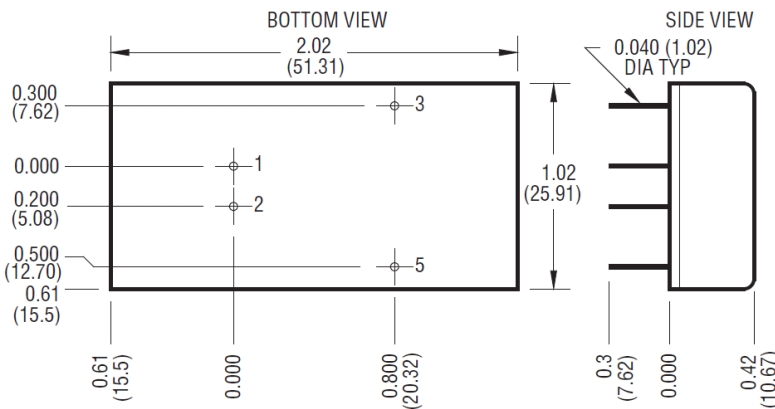

Figure 1. Typical Performance: (Tc = 25°C, Vin = Nom VDC, Rated Load)



PIN	FUNCTION
1	+ INPUT
2	- INPUT
3	+ OUT
4	NO PIN
5	- OUT

Mechanical tolerances unless otherwise noted:

X.XX dimensions: ±0.020 inches
X.XXX dimensions: ±0.005 inches

Figure 2. Mechanical Dimensions

For more information on these products consult: tech.support@psbel.com

NUCLEAR AND MEDICAL APPLICATIONS - Products are not designed or intended for use as critical components in life support systems, equipment used in hazardous environments, or nuclear control systems.

TECHNICAL REVISIONS - The appearance of products, including safety agency certifications pictured on labels, may change depending on the date manufactured. Specifications are subject to change without notice.



Asia-Pacific
+86 755 298 85888

Europe, Middle East
+353 61 225 977

North America
+1 408 785 5200