

DESCRIPTION: M12 MALE - CABLE MOUNT - 4 POS.

UNITS = INCHES [MM]

NOTE:

MATERIAL	
HOUSING:	PBT UL94V-0, BLACK
CONTACT:	BRASS
NUT:	ALUMINUM ALLOY
SHELL:	ALUMINUM ALLOY
MAIN BODY:	ALUMINUM ALLOY
GLAND:	SILICONE, BLACK
GLAND CAGE:	PDM, BLACK
GLAND NUT:	BRASS

FINISH	
CONTACT:	GOLD PLATED OVER 50µ" NICKEL
NUT:	NICKEL PLATED
SHELL:	NICKEL PLATED
MAIN BODY:	NICKEL PLATED
GLAND NUT:	NICKEL PLATED
ELECTRICAL	
RATED CURRENT:	5A
RATED VOLTAGE:	125V
INSULATION RESISTANCE:	100 MΩhms MIN.
CONTACT RESISTANCE:	10 MΩhms MAX.
WATER PROOF:	IP67
ENVIRONMENT	
OPERATION TEMPERATURE:	-40°C TO +85°C
WIRE GAUGE:	24-28 AWG

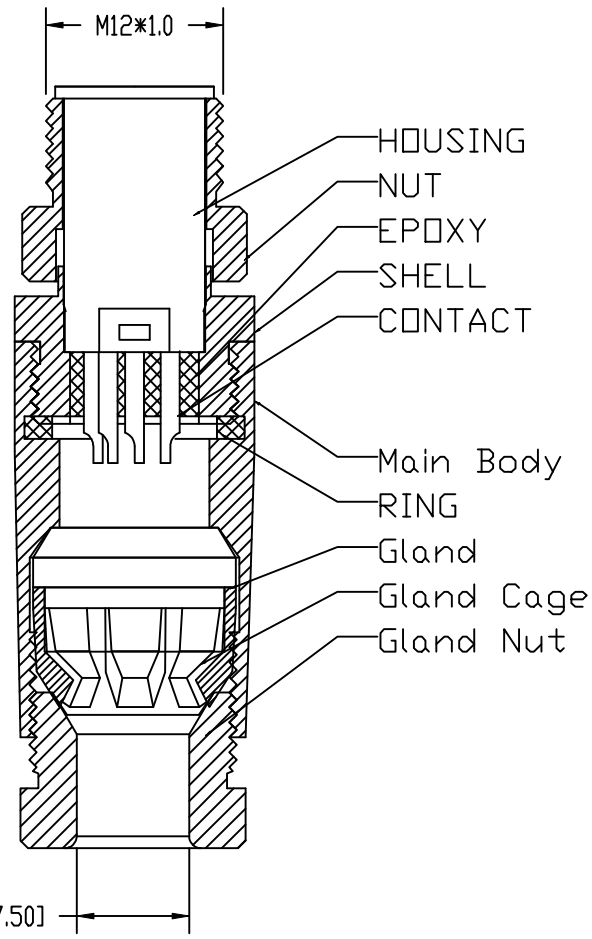
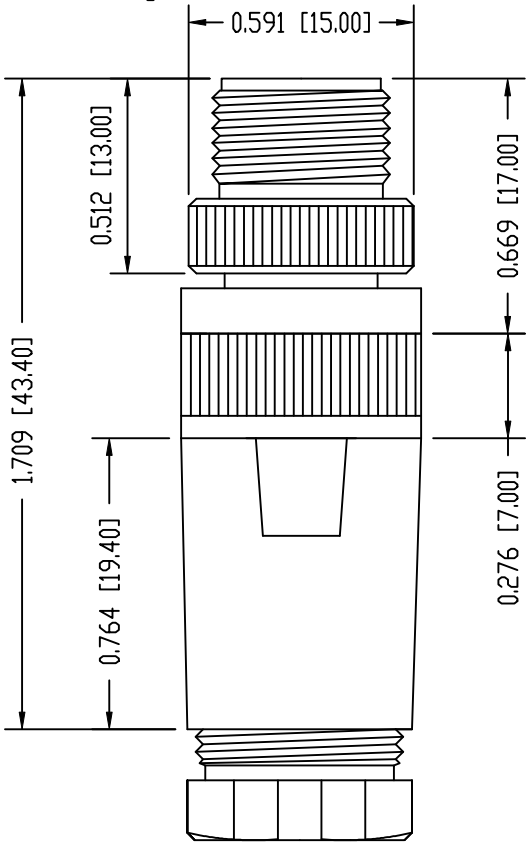
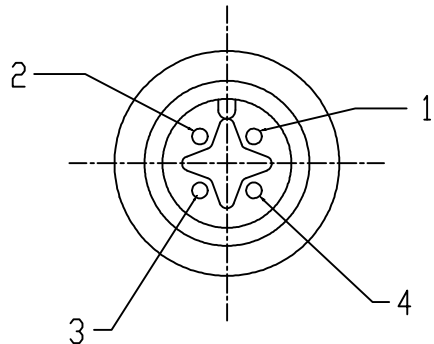

858-004-103RKTY

1 = GOLD FLASH
4 = 10µ" GOLD

RoHS COMPLIANT

DO NOT SCALE FROM DRAWING



THESE DRAWINGS AND SPECIFICATIONS ARE THE PROPERTY OF NorComp AND SHALL NOT BE REPRODUCED, COPIED OR USED AS THE BASIS FOR THE MANUFACTURE OR SALE OF APPARATUS WITHOUT WRITTEN PERMISSION.

DRAWN:	M. SIGMON	DATE:	03-07-16
CHECKED:		DATE:	

NorComp

SCALE:	N.T.S.	SHEET	1	OF	1	REV	1
DWG NO.	858-004-103RKTY						