



Pushbutton  
A

# NE-18 Series Mains / Power Switches

## Features/Benefits

- Chassis or panel mount
- Various buttons
- Various contact configurations
- RoHS compliant

## Typical Applications

- Mains/power switching
- Consumer electronics
- Audio equipment
- Digital products

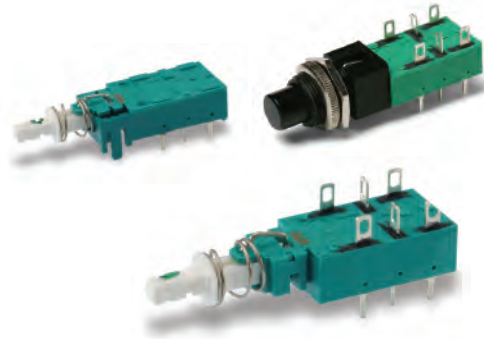

UL61058-1



## Specifications

ELECTRICAL RATING:

NE18 Series:

- 8A GP, 125 VAC, 50/60 Hz, 1E4, T70
- 6A GP, 250 VAC, 50/60 Hz, 1E4, T70
- 6(4)A RM, 250 VAC, 50/60 Hz, 1E4, T70
- 6/48A RC, 250 VAC, 50/60 Hz, 1E4, T70
- 1RA, 100 VDC, 1E4, T70
- 8RA, 30VDC, 1E4, T70

NE18CTII Series:

- 4A GP, 250 VAC, 50/60 Hz, 1E4, T70
- 4/48A RC, 250 VAC, 50/60 Hz, 1E4, T70
- 1RA, 100 VDC, 1E4, T70
- 4RA, 30VDC, 1E4, T70

DIELECTRIC STRENGTH (50 Hz, 1 min.): 2000 V

OPERATING LIFE AT MAX. LOAD AND AT MAX. INRUSH CURRENT:  $\wedge 10^4$  operations<sup>5)</sup>

CONTACT RESISTANCE: Initial: 50m $\Omega$ ; After  $10^4$  operations: 70m $\Omega$ .

INSULATION RESISTANCE:  $\wedge 10^{12}$   $\Omega$ chassis – nearest contact;  $\wedge 10^{12}$   $\Omega$ mains contact – mains contact;  $\wedge 10^{12}$   $\Omega$ mains contact – mains contact after  $10^4$  operations.

LOW VOLTAGE CONTACT:

SWITCHING POWER MAX.: 12W

SWITCHING VOLTAGE MAX.: 24V

SWITCHING CURRENT MAX.: 0.5A

TOTAL TRAVEL: 4.7mm (.185 inch)

LATCHING TRAVEL: 3.3mm (.130 inch)

OPERATING FORCE: Without auxiliary low voltage contacts:

NE18: 7N (700 grams); NE18CTII: 9.5N (950 grams).

With auxiliary low voltage contacts: NE18: 8N (800 grams);

NE18CTII: 11N (1100 grams).

SEALING: Dust proof.

## Materials

HOUSING, ACTUATOR & TERMINAL BOARD: Thermoplastic polyester (UL 94V-0).

MOVABLE CONTACT: Silver nickel alloy, silver plated.

FIXED CONTACTS: Silver nickel alloy, silver plated.

COMMON CONTACTS & TERMINALS: Copper alloy, silver plated.

RETURN SPRING: Music wire.

**NOTE:** All models are RoHS compliant and compatible.

**NOTE:** Specifications and materials listed above are for switches with standard options. For information on specific and custom switches, consult Customer Service Center.

## Build-A-Switch

To order, simply select desired option from each category and place in the appropriate box. Available options are shown and described on pages A-97 thru A-104. For additional options not shown in catalog, consult Customer Service Center.

If requesting only a switch, select the switch as noted below. Buttons are sold separately.

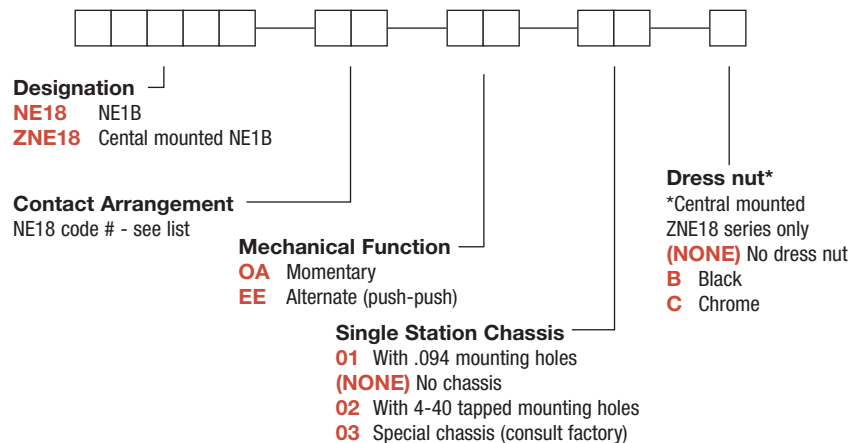

Dimensions are shown: Inches (mm)  
Specifications and dimensions subject to change

# NE-18 Series Mains / Power Switches



A

Pushbutton

## Order Code - Buttons

### Solid Buttons

<p><b>Style</b></p> <p><b>F01</b> FMR</p> <p><b>F02</b> FG*</p> <p><b>F12</b> FSC</p> <p><b>F13</b> FSD</p> <p><b>F14</b> FU12</p> <p><b>F15</b> FSB</p> <p><b>F16</b> FE</p> <p><b>F19</b> FA</p> <p><b>F21</b> F001</p>	<p><b>Button Color</b></p> <p><b>01</b> Black</p> <p><b>02</b> White</p> <p><b>03</b> Red</p> <p><b>04</b> Light gray</p>

### Mechanical Indicator Buttons

<p><b>Style</b></p> <p><b>F01</b> FA100</p> <p><b>F02</b> FA101</p> <p><b>F07</b> FA120</p> <p><b>F08</b> FA201</p> <p><b>F11</b> FA200*</p>	<p><b>Shell Color</b></p> <p><b>01</b> Black</p>	<p><b>Out Position Color</b></p> <p><b>01</b> Black</p>	<p><b>In Position Color</b></p> <p><b>02</b> White</p> <p><b>06</b> Yellow</p> <p><b>07</b> Blue</p> <p><b>08</b> Green</p> <p><b>12</b> Orange</p>

\*Button options for central mounting configurations, use 'FG' for central mount with chrome dress nut, use 'FA200' for central mount with black dress nut.

### BUTTON REMOVAL

A button of a push-push switch should only be removed in the "OFF" non-latching position.

## DESIGNATION & SWITCHES WITH STANDARD OPTIONS



### NE1838EE

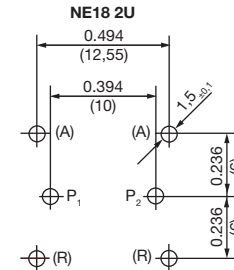
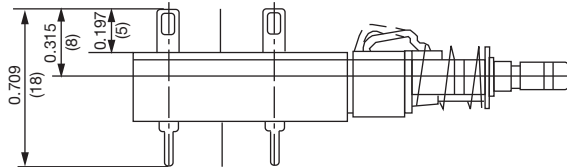
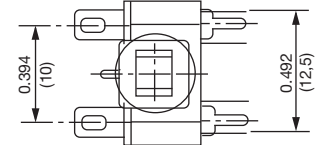
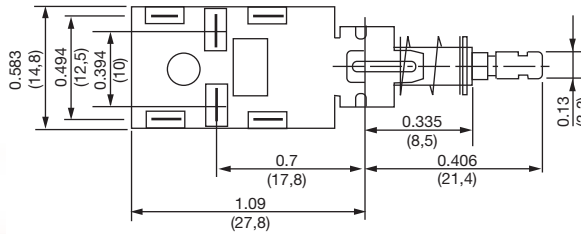

Dimensions are shown: Inches (mm)  
Specifications and dimensions subject to change



# NE-18 Series Mains / Power Switches

## DESIGNATION & SWITCHES WITH STANDARD OPTIONS



Pushbutton

### NE1839EE

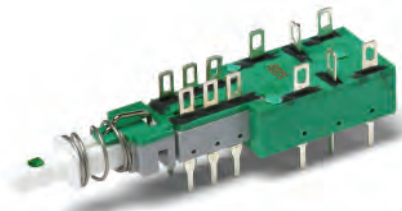
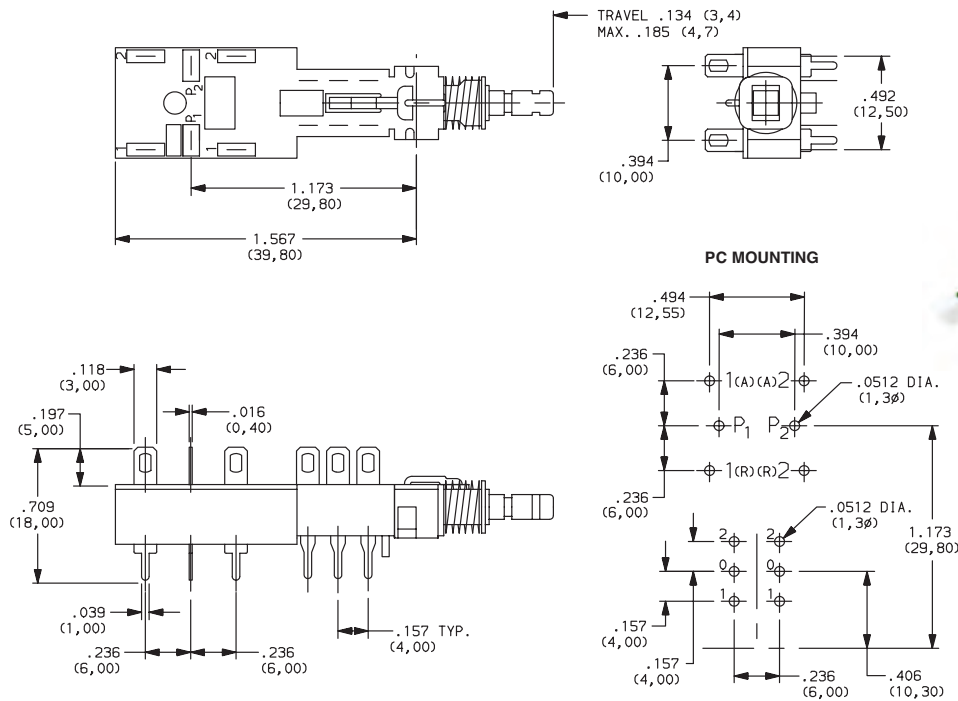

### NE1846EE

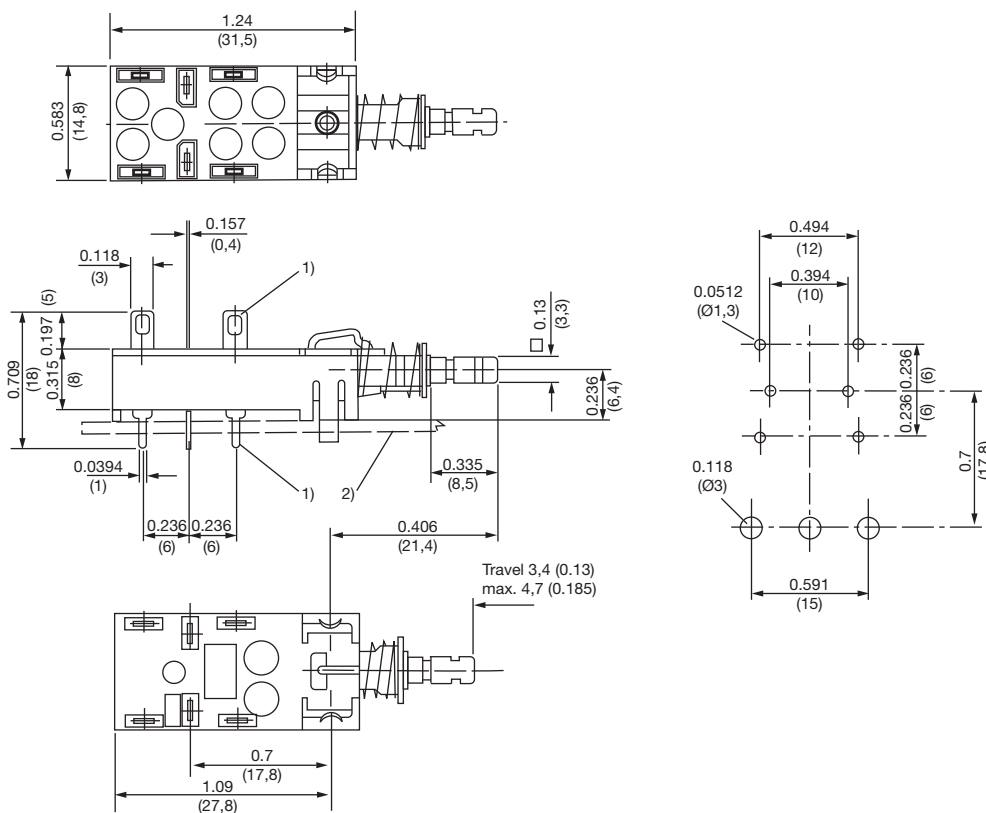

Dimensions are shown: Inches (mm)  
Specifications and dimensions subject to change



# NE-18 Series Mains / Power Switches

DESIGNATION & SWITCHES WITH STANDARD OPTIONS



ZNE1838EECF0201

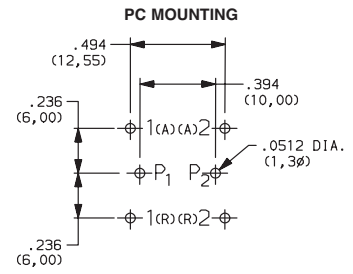
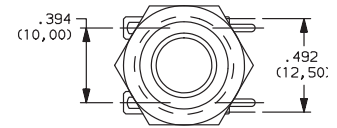
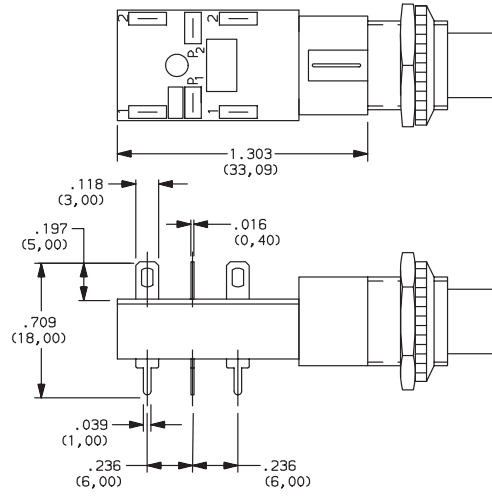

A

Pushbutton

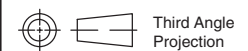

Third Angle  
Projection

Dimensions are shown: Inches (mm)  
Specifications and dimensions subject to change



# NE-18 Series Mains / Power Switches

## CONTACT ARRANGEMENT



Pushbutton  
A







OPTION CODE Contact capacity and availability	STYLE	ELECTRICAL CIRCUIT
<b>37</b>	NE18 – 2AX	DPST
<b>38</b>	NE18 – 2UX	DPDT
<b>51</b>	2U + NE18 – 2AX	DPST*
<b>52 (4A/64)</b>	NE18CTII – 2AX	DPST
<b>39</b>	2U + NE18 – 2UX	DPDT*
<b>41</b>	NE18 – 2AP	DPST
<b>42</b>	NE18 – 2UP	DPDT
<b>43</b>	NE18 – 2AW	DPST
<b>44</b>	NE18 – 2UW	DPDT
<b>45</b>	NE18 – 2ASX	DPST

OPTION CODE Contact capacity and availability	STYLE	ELECTRICAL CIRCUIT
<b>46</b>	NE18 – 2USX	DPDT
<b>47</b>	NE18 – 2ASP	DPST
<b>48</b>	NE18 – 2USP	DPDT
<b>49</b>	NE18 – 2ASW	DPST
<b>50</b>	NE18 – 2USW	DPDT
<b>53 (4A/64)</b>	2U + NE18CTII – 2AX	DPST
<b>54</b>	2U + NE18 – 2AW	DPST
<b>55</b>	2U + NE18 – 2AP	DPST
<b>56</b>	2U + NE18 – 2UW	DPDT
<b>57</b>	2U + NE18 – 2UP	DPDT

\* 2U + Denotes auxiliary set of low current contacts DPDT  
2A = DPST  
2U = DPDT  
S = Snap-in mounting  
X = Solder lug/PC pins  
W = Solder lugs only  
P = PC pins only

### NOTES

- Contact plating is silver on all Power Switches.
- The electrical function is Break Before Make (BBM) on all Power Switches.
- The terminals will be epoxy sealed.

TYPE	POSSIBLE CONTACT ARRANGEMENT		CONTACT SPACING	PROTECTION CLASS (CEE 24)	APPROVALS
	POWER CONTACTS <sup>1</sup>	AUXILIARY CONTACTS			
NE18	2A <sup>2</sup>	2U	> 3mm (.118 inch)	II	  UL61058-1
NE18	2A <sup>2</sup> 2U	2U	> 3mm (.118 inch)	I	  UL61058-1
NE18CTII	2A <sup>2</sup>	2U	> 3mm (.118 inch)	II	  UL61058-1

- A = make contact, U = changeover contact
- With 2A mains contacts: Mounting only by PC pins is not sufficient.

## MECHANICAL FUNCTION



OPTION CODE	FUNCTION
<b>OA</b>	Momentary
<b>EE</b>	Alternate (push-push)



Dimensions are shown: Inches (mm)  
Specifications and dimensions subject to change

# NE-18 Series Mains / Power Switches



A

Pushbutton

## SINGLE STATION CHASSIS



**01** WITH .094 MOUNTING HOLES

**(NONE)** NO CHASSIS

**02** WITH 4-40 TAPPED MOUNTING HOLES

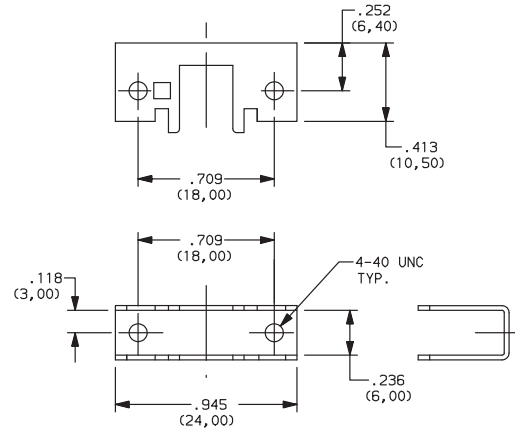
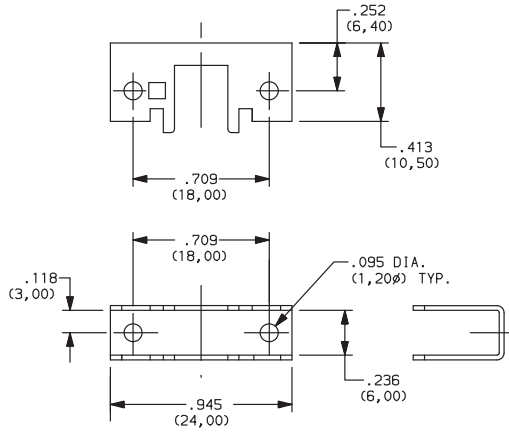

**03** SPECIAL CHASSIS (CONSULT FACTORY)

## DRESS NUT



**(NONE)** NO DRESS NUT

**B** BLACK

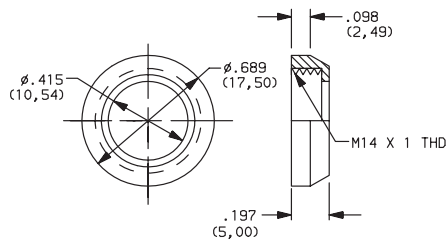

PANEL CUTOUT

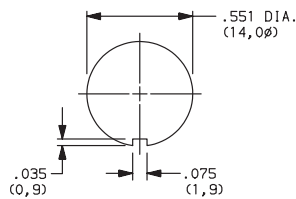

**NOTE:** Available with ZNE18 designation and FA200 buttons.

**C** CHROME

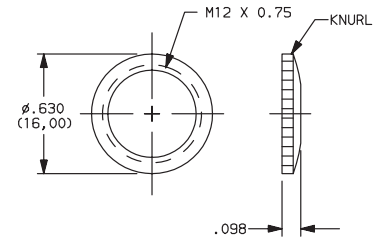

PANEL CUTOUT

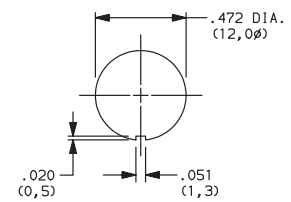

**NOTE:** Available with ZNE18 designation and FG button.



Dimensions are shown: Inches (mm)  
Specifications and dimensions subject to change



# NE-18 Series Mains / Power Switches

## SOLID BUTTON

Pushbutton  
A

### STYLE

**F01** FMR

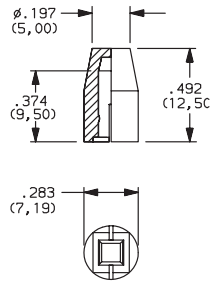

**F02** FG

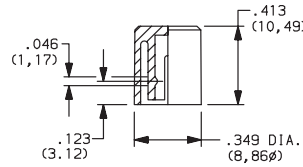

**F12** FSC

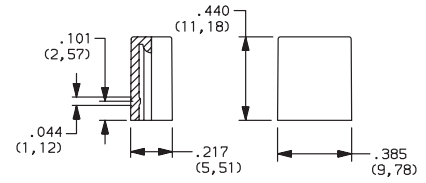

**F13** FSD

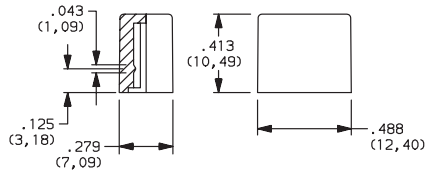
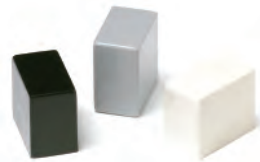

**F14** FU12

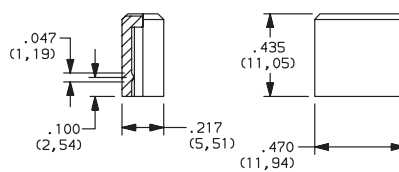

**F15** FSB

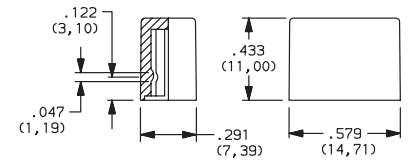
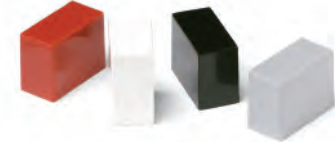

**F16** FE

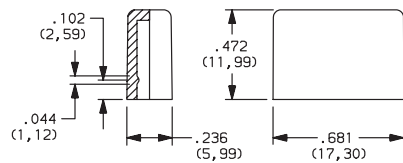

**F19** FA

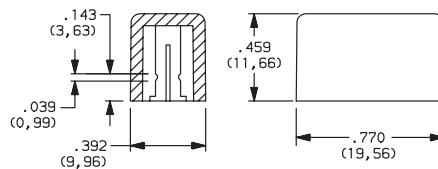

OPTION CODE	COLOR
<b>01</b>	BLACK
<b>02</b>	WHITE
<b>03</b>	RED
<b>04</b>	LT. GRAY



Dimensions are shown: Inches (mm)  
Specifications and dimensions subject to change



# NE-18 Series Mains / Power Switches



A

Pushbutton

## SOLID BUTTON



### STYLE

**F21** F001

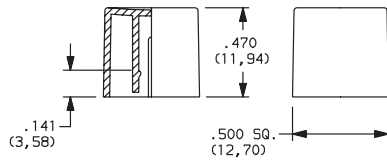

OPTION CODE	COLOR
<b>01</b>	BLACK
<b>02</b>	WHITE
<b>03</b>	RED
<b>04</b>	LT. GRAY
<b>09</b>	BLACK/CHROME (F03, F06 & F07 buttons only)

## MECHANICAL BUTTON

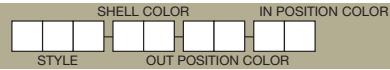

### STYLE

**F01** FA100

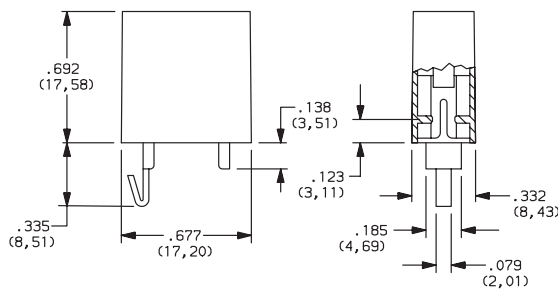

**F02** FA101

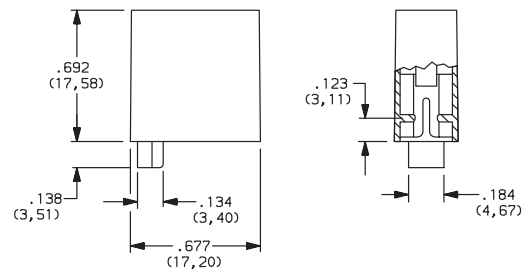

Third Angle  
Projection

Dimensions are shown: Inches (mm)  
Specifications and dimensions subject to change





# NE-18 Series Mains / Power Switches

## MECHANICAL BUTTON

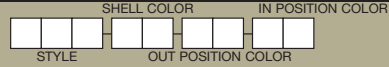

Pushbutton  
A

### STYLE

**F08** FA201

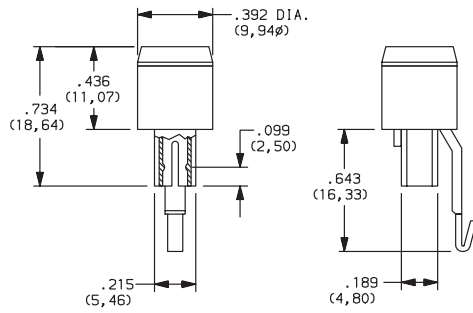

**F11** FA200

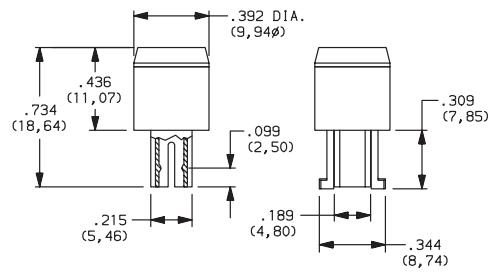

### SHELL COLOR

**01** BLACK

### OUT POSITION COLOR

**01** BLACK

### IN POSITION COLOR

OPTION CODE	COLOR
<b>02</b>	WHITE
<b>06</b>	YELLOW
<b>07</b>	BLUE
<b>08</b>	GREEN
<b>12</b>	ORANGE



Dimensions are shown: Inches (mm)  
Specifications and dimensions subject to change