

1 Msps 16/14/12-Bit Differential Input SAR ADC

Features

- Sample Rate (Throughput): 1 Msps
- 16/14/12-Bit Resolution with No Missing Codes
- No Latency Output
- Wide Operating Voltage Range:
 - Analog Supply Voltage (V_{DD}): 1.8V
 - Digital Input/Output Interface Voltage (DV_{IO}): 1.7V - 5.5V
 - External Reference (V_{REF}): 2.5V - 5.1V
- Differential Input Operation
 - Input Full-Scale Range: $-V_{REF}$ to $+V_{REF}$
- Ultra Low Current:
 - Standby Mode (typical): $\sim 0.8 \mu A$
 - Conversion Mode (typical): $\sim 1.6 mA$
- SPI-Compatible Serial Communication:
 - SCLK Clock Rate: up to 100 MHz
- ADC Self-Calibration for Offset, Gain, and Linearity Errors:
 - During Power-Up (automatic)
 - On-Demand via user's command during normal operation
- Temperature Range: $-40^{\circ}C$ to $+85^{\circ}C$
- Package Options: MSOP-10 and TDFN-10

Typical Applications

- High-Precision Data Acquisition
- Medical Instruments
- Industrial and Consumer Data Acquisition Systems
- Motor Control Applications
- Switch-Mode Power Supply Applications
- Battery-Powered Equipment

System Design Supports

The MCP331x1D Evaluation Kit demonstrates the performance of the MCP331x1D SAR ADC family devices. The evaluation kit includes: (a) MCP331x1D Evaluation Board, (b) PIC32MZ EF Curiosity Board for data collection, and (c) SAR ADC Utility PC GUI.

Contact Microchip Technology Inc. for the evaluation tools and the PIC32 MCU firmware example codes.

Package Types

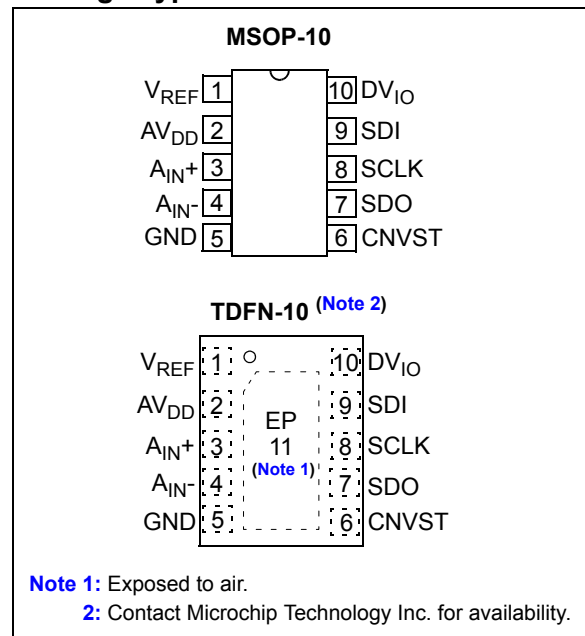

Device Offering (Note 1):

Part Number	Resolution	Sample Rate	Input Type	Input Range (Differential)	Performance (Typical)				
					SNR	SFDR	THD	INL	DNL
MCP33131D-10	16-bit	1 Msps	Differential	$\pm 5.1V$	91.3 dBFS	103.5 dB	-99.3 dB	± 2 LSB	± 0.8 LSB
MCP33121D-10	14-bit	1 Msps	Differential	$\pm 5.1V$	85.1 dBFS	103.5 dB	-99.2 dB	± 0.5 LSB	± 0.25 LSB
MCP33111D-10	12-bit	1 Msps	Differential	$\pm 5.1V$	73.9 dBFS	99.3 dB	-96.7 dB	± 0.12 LSB	± 0.06 LSB

Note 1: SNR, SFDR, and THD are measured with $f_{IN} = 10$ kHz, $V_{IN} = -1$ dBFS, $V_{REF} = 5V$.

MCP33131D/21D/11D-10

Application Diagram

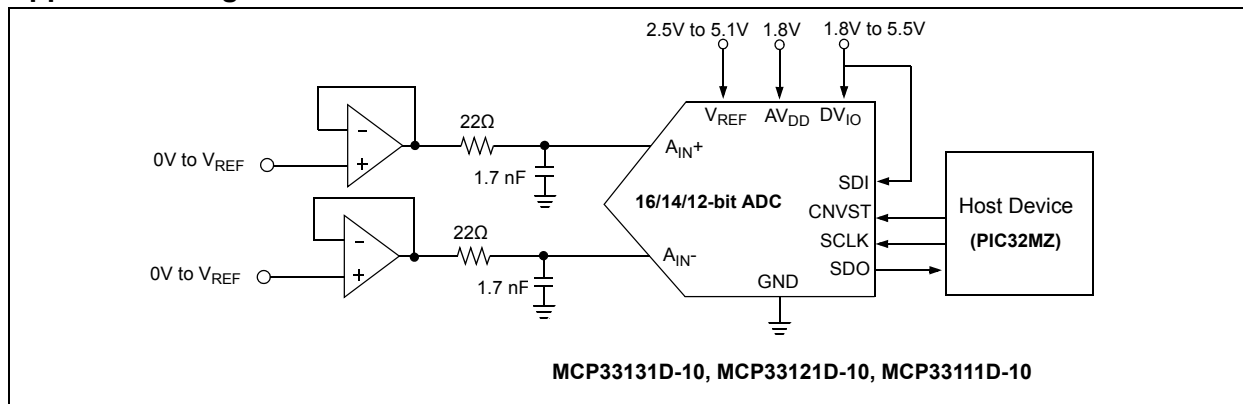

Description

The MCP331x1D-10 are fully-differential 16, 14, and 12-bit, 1 Msps single-channel ADC family devices, featuring low power consumption and high performance, using a successive approximation register (SAR) architecture.

The device operates with a 2.5V to 5.1V external reference (V_{REF}), which supports a wide range of input full-scale range from $-V_{REF}$ to $+V_{REF}$. The reference voltage setting is independent of the analog supply voltage (AV_{DD}) and is higher than AV_{DD} . The conversion output is available through an easy-to-use simple SPI-compatible 3-wire interface.

The device requires a 1.8V analog supply voltage (AV_{DD}) and a 1.7V to 5.5V digital I/O interface supply voltage (DV_{IO}). The wide digital I/O interface supply (DV_{IO}) range (1.7V - 5.5V) allows the device to interface with most host devices (Master) available in the current industry such as the PIC32 microcontrollers, without using external voltage level shifters.

When the device is first powered-up, it performs a self-calibration to minimize offset, gain and linearity errors. The device performance stays very stable across all temperature ranges without any noticeable degradation. However, when changes in the operating environment, such as temperature or reference voltage, are made with respect to the initial conditions, or the reference voltage was not fully settled during the initial power-up sequence, the user may send a recalibrate command anytime to initiate another self-calibration to maintain optimum performance.

When the initial power-up sequence is completed, the device enters a low-current input acquisition mode, where sampling capacitors are connected to the input pins. This mode is called Standby.

During Standby, most of the internal analog circuitry is shutdown in order to reduce current consumption. Typically, the device consumes less than 1 μA during Standby.

A new conversion is started on the rising edge of CNVST. When the conversion is complete and the host lowers CNVST, the output data is presented on SDO, and the device enters Standby to begin acquiring the next input sample. The user can clock out the ADC output data using the SPI-compatible serial clock during Standby.

The ADC system clock is generated by the internal on-chip clock, therefore the conversion is performed independent of the SPI serial clock (SCLK).

This device can be used for various high-speed and high-accuracy analog-to-digital data conversion applications, where design simplicity, low power, and no output latency are needed.

The device is available in a Pb-free small MSOP-10 and TDFN-10 packages. The device operates over the commercial temperature range of $-40^{\circ}C$ to $+85^{\circ}C$.

1.0 KEY ELECTRICAL CHARACTERISTICS

1.1 Absolute Maximum Ratings†

External Analog Supply Voltage (AV _{DD}).....	-0.3V to 2.0V
External Digital Supply Voltage (DV _{IO}).....	-0.3V to 5.8V
External Reference Voltage (V _{REF}).....	-0.3V to 5.8V
Analog inputs w.r.t GND	-0.3V to V _{REF} +0.3V
Current at Input Pins	±2 mA
Current at Output and Supply Pins	±250 mA
Storage Temperature	-65°C to +150°C
Maximum Junction Temperature (T _J).....	+150°C
ESD protection on all pins	≤ 2 kV HBM, ≤ 200V MM

†**Notice:** Stresses above those listed under “Absolute Maximum Ratings” may cause permanent damage to the device. This is a stress rating only and functional operation of the device at those or any other conditions above those indicated in the operational listings of this specification is not implied. Exposure to maximum rating conditions for extended periods may affect device reliability.

1.2 Electrical Specifications

TABLE 1-1: KEY ELECTRICAL CHARACTERISTICS

Electrical Specifications: Unless otherwise specified, all parameters apply for T _A = -40°C to +85°C, AV _{DD} = 1.8V, DV _{IO} = 3.3V, V _{REF} = 5V, GND = 0V, Differential Analog Input (V _{IN}) = -1 dBFS sine wave, f _{IN} = 10 kHz, SPI Clock Input (SCLK) = 60 MHz, Sample Rate (f _S) = 1 Msps.						
Parameters	Sym.	Min.	Typ.	Max.	Units	Conditions
Power Supply Requirements						
Analog Supply Voltage Range	AV _{DD}	1.7	1.8	1.9	V	(Note 3)
Digital Input/Output Interface Voltage Range	DV _{IO}	1.7	—	5.5	V	(Note 3)
Analog Supply Current at AV _{DD} pin: During Conversion During Standby	I _{DDAN} I _{DDAN_STBY}	— —	1.6 0.8	2.4 —	mA µA	f _S = 1 Msps Input acquisition (t _{ACQ})
Digital Supply Current At DV _{DD} pin: During Output Data Reading During Standby	I _{IO_DATA} I _{IO_STBY}	— —	290 30	— —	µA nA	f _S = 1 Msps Input acquisition (t _{ACQ})
External Reference Voltage Input						
Reference Voltage	V _{REF}	2.5	—	5.1	V	(Note 2), (Note 3)
Reference Load Current at V _{REF} pin: During Conversion During Standby	I _{REF} I _{REF_STBY}	— —	450 240	600 —	µA nA	f _S = 1 Msps Input acquisition (t _{ACQ})
Total Power Consumption						
Total Power Consumption at 1 Msps at 500 ksps at 100 ksps During Standby	P _{DISS_TOTAL} P _{DISS_STBY}	— — — —	6.2 3.1 0.6 2.6	— — — —	mW mW mW µW	Including AV _{DD} , DV _{IO} , V _{REF} pins Averaged power for t _{ACQ} + t _{CNV} Input acquisition (t _{ACQ})

- Note**
- 1: This parameter is ensured by design and not 100% tested.
 - 2: This parameter is ensured by characterization and not 100% tested.
 - 3: Decoupling capacitor is recommended on the following pins:
(a) AV_{DD} pin: 1 µF ceramic capacitor, (b) DV_{IO} pin: 0.1 µF ceramic capacitor, (c) V_{REF} pin: 10 µF tantalum capacitor.
 - 4: Differential Input Full-Scale Range (FSR) = 2 x V_{REF}
 - 5: PSRR (dB) = -20 log (D_{VOU}T/AV_{DD}), where D_{VOU}T = change in conversion result.
 - 6: ENOB = (SINAD - 1.76)/6.02

MCP33131D/21D/11D-10

TABLE 1-1: KEY ELECTRICAL CHARACTERISTICS (CONTINUED)

Electrical Specifications: Unless otherwise specified, all parameters apply for $T_A = -40^{\circ}\text{C}$ to $+85^{\circ}\text{C}$, $AV_{DD} = 1.8\text{V}$, $DV_{IO} = 3.3\text{V}$, $V_{REF} = 5\text{V}$, $\text{GND} = 0\text{V}$, Differential Analog Input (V_{IN}) = -1 dBFS sine wave, $f_{IN} = 10\text{ kHz}$, SPI Clock Input (SCLK) = 60 MHz, Sample Rate (f_S) = 1 Msps.

Parameters	Sym.	Min.	Typ.	Max.	Units	Conditions
Analog Inputs						
Input Voltage Range (Note 2)	A_{IN+}	-0.1	—	$V_{REF}+0.1$	V	Differential Input: $V_{IN} = (A_{IN+} - A_{IN-})$
	A_{IN-}	-0.1	—	$V_{REF}+0.1$	V	
Input Full-Scale Voltage Range	FSR	$-V_{REF}$	—	$+V_{REF}$	V_{PP}	Differential Input (Note 2), (Note 4)
Input Common-Mode Voltage Range	V_{CM}	0	$V_{REF}/2$	V_{REF}		(Note 2)
Input Sampling Capacitance	C_S	—	31	—	pF	(Note 1)
Leakage Current at Analog Input Pin	$I_{LEAK_AN_INPUT}$	—	± 2	± 100	nA	During Standby
Sampling Dynamics						
Sample Rate	f_S	—	—	1	Msps	Throughput rate
Input Acquisition Time	t_{ACQ}	290	—	—	ns	(Note 2)
Data Conversion Time	t_{CNV}	—	560	710	ns	
Time between Conversions	t_{CYC}	1	—	—	μs	$t_{CYC} = t_{ACQ} + t_{CNV}$, $f_S = 1\text{ Msps}$
-3dB Input Bandwidth	BW_{-3dB}	—	25	—	MHz	(Note 1)
Aperture Delay (Note 1)		—	2.5	—	ns	Time delay between CNVST rising edge and when input is sampled
System Performance						
Resolution (No Missing Codes)		16	—	—	Bits	MCP33131D-10
		14	—	—	Bits	MCP33121D-10
		12	—	—	Bits	MCP33111D-10
Integral Nonlinearity	INL	-6	± 2	+6	LSB	MCP33131D-10
		-1.5	± 0.5	+1.5	LSB	MCP33121D-10
			± 0.12		LSB	MCP33111D-10
Differential Nonlinearity	DNL	-0.98	± 0.8	+1.8	LSB	MCP33131D-10
		-0.8	± 0.25	+0.8	LSB	MCP33121D-10
		-0.3	± 0.06	+0.3	LSB	MCP33111D-10
Offset Error			± 0.1	± 2.3	mV	MCP33131D-10
			± 0.125	± 3	mV	MCP33121D-10
			± 0.8	± 3.66	mV	MCP33111D-10
Offset Error Drift with Temperature		—	± 0.5	—	$\mu\text{V}/^{\circ}\text{C}$	
Gain Error	G_{ER}		± 2	—	LSB	MCP33131D-10
			± 0.5	—	LSB	MCP33121D-10
			± 0.1	—	LSB	MCP33111D-10
Gain Error Drift with temperature		—	± 0.35	—	$\mu\text{V}/^{\circ}\text{C}$	
Input common-mode rejection ratio	CMRR	—	84	—	dB	
Power Supply Rejection Ratio	PSRR	—	70	—	dB	(Note 5)

- Note**
- 1: This parameter is ensured by design and not 100% tested.
 - 2: This parameter is ensured by characterization and not 100% tested.
 - 3: Decoupling capacitor is recommended on the following pins:
(a) AV_{DD} pin: 1 μF ceramic capacitor, (b) DV_{IO} pin: 0.1 μF ceramic capacitor, (c) V_{REF} pin: 10 μF tantalum capacitor.
 - 4: Differential Input Full-Scale Range (FSR) = $2 \times V_{REF}$
 - 5: PSRR (dB) = $-20 \log (D_{VOUT}/AV_{DD})$, where D_{VOUT} = change in conversion result.
 - 6: ENOB = $(\text{SINAD} - 1.76)/6.02$

MCP33131D/21D/11D-10

TABLE 1-1: KEY ELECTRICAL CHARACTERISTICS (CONTINUED)

Electrical Specifications: Unless otherwise specified, all parameters apply for $T_A = -40^{\circ}\text{C}$ to $+85^{\circ}\text{C}$, $AV_{DD} = 1.8\text{V}$, $DV_{IO} = 3.3\text{V}$, $V_{REF} = 5\text{V}$, $\text{GND} = 0\text{V}$, Differential Analog Input (V_{IN}) = -1 dBFS sine wave, $f_{IN} = 10\text{ kHz}$, SPI Clock Input (SCLK) = 60 MHz, Sample Rate (f_S) = 1 Msps.						
Parameters	Sym.	Min.	Typ.	Max.	Units	Conditions
Dynamic Performance						
Signal-to-Noise Ratio	SNR	MCP33131D-10: 16-bit ADC				
		—	91.6	—	dBFS	$V_{REF} = 5\text{V}$, $f_{IN} = 1\text{ kHz}$
		—	86.6	—		$V_{REF} = 2.5\text{V}$, $f_{IN} = 1\text{ kHz}$
		88.7	91.3	—		$V_{REF} = 5\text{V}$, $f_{IN} = 10\text{ kHz}$
		—	86.6	—		$V_{REF} = 2.5\text{V}$, $f_{IN} = 10\text{ kHz}$
		MCP33121D-10: 14-bit ADC				
		—	85.2	—	dBFS	$V_{REF} = 5\text{V}$, $f_{IN} = 1\text{ kHz}$
		—	83.5	—		$V_{REF} = 2.5\text{V}$, $f_{IN} = 1\text{ kHz}$
		81.7	85.1	—		$V_{REF} = 5\text{V}$, $f_{IN} = 10\text{ kHz}$
		—	83.5	—		$V_{REF} = 2.5\text{V}$, $f_{IN} = 10\text{ kHz}$
		MCP33111D-10: 12-bit ADC				
		—	73.9	—	dBFS	$V_{REF} = 5\text{V}$, $f_{IN} = 1\text{ kHz}$
		—	73.8	—		$V_{REF} = 2.5\text{V}$, $f_{IN} = 1\text{ kHz}$
		71.1	73.9	—		$V_{REF} = 5\text{V}$, $f_{IN} = 10\text{ kHz}$
		—	73.8	—		$V_{REF} = 2.5\text{V}$, $f_{IN} = 10\text{ kHz}$
		Signal-to-Noise and Distortion Ratio (Note 6)	SINAD	MCP33131D-10: 16-bit ADC		
—	91.5			—	dBFS	$V_{REF} = 5\text{V}$, $f_{IN} = 1\text{ kHz}$
—	86.6			—		$V_{REF} = 2.5\text{V}$, $f_{IN} = 1\text{ kHz}$
—	91			—		$V_{REF} = 5\text{V}$, $f_{IN} = 10\text{ kHz}$
—	86.2			—		$V_{REF} = 2.5\text{V}$, $f_{IN} = 10\text{ kHz}$
MCP33121D-10: 14-bit ADC						
—	85.2			—	dBFS	$V_{REF} = 5\text{V}$, $f_{IN} = 1\text{ kHz}$
—	83.5			—		$V_{REF} = 2.5\text{V}$, $f_{IN} = 1\text{ kHz}$
—	85			—		$V_{REF} = 5\text{V}$, $f_{IN} = 10\text{ kHz}$
—	83.3			—		$V_{REF} = 2.5\text{V}$, $f_{IN} = 10\text{ kHz}$
MCP33111D-10: 12-bit ADC						
—	73.9			—	dBFS	$V_{REF} = 5\text{V}$, $f_{IN} = 1\text{ kHz}$
—	73.8			—		$V_{REF} = 2.5\text{V}$, $f_{IN} = 1\text{ kHz}$
—	73.9			—		$V_{REF} = 5\text{V}$, $f_{IN} = 10\text{ kHz}$
—	73.8			—		$V_{REF} = 2.5\text{V}$, $f_{IN} = 10\text{ kHz}$

- Note**
- 1: This parameter is ensured by design and not 100% tested.
 - 2: This parameter is ensured by characterization and not 100% tested.
 - 3: Decoupling capacitor is recommended on the following pins:
(a) AV_{DD} pin: 1 μF ceramic capacitor, (b) DV_{IO} pin: 0.1 μF ceramic capacitor, (c) V_{REF} pin: 10 μF tantalum capacitor.
 - 4: Differential Input Full-Scale Range (FSR) = $2 \times V_{REF}$
 - 5: PSRR (dB) = $-20 \log(D_{VOUT}/AV_{DD})$, where D_{VOUT} = change in conversion result.
 - 6: ENOB = $(\text{SINAD} - 1.76)/6.02$

MCP33131D/21D/11D-10

TABLE 1-1: KEY ELECTRICAL CHARACTERISTICS (CONTINUED)

Electrical Specifications: Unless otherwise specified, all parameters apply for $T_A = -40^\circ\text{C}$ to $+85^\circ\text{C}$, $AV_{DD} = 1.8\text{V}$, $DV_{IO} = 3.3\text{V}$, $V_{REF} = 5\text{V}$, $GND = 0\text{V}$, Differential Analog Input (V_{IN}) = -1 dBFS sine wave, $f_{IN} = 10\text{ kHz}$, SPI Clock Input (SCLK) = 60 MHz, Sample Rate (f_S) = 1 Msps.

Parameters	Sym.	Min.	Typ.	Max.	Units	Conditions
Spurious Free Dynamic Range	SFDR	MCP33131D-10: 16-bit ADC				
		—	103.7	—	dBc	$V_{REF} = 5\text{V}$, $f_{IN} = 1\text{ kHz}$
		—	98	—		$V_{REF} = 2.5\text{V}$, $f_{IN} = 1\text{ kHz}$
		—	103.5	—		$V_{REF} = 5\text{V}$, $f_{IN} = 10\text{ kHz}$
		—	97.5	—		$V_{REF} = 2.5\text{V}$, $f_{IN} = 10\text{ kHz}$
		MCP33121D-10: 14-bit ADC				
		—	103.6	—	dBc	$V_{REF} = 5\text{V}$, $f_{IN} = 1\text{ kHz}$
		—	98	—		$V_{REF} = 2.5\text{V}$, $f_{IN} = 1\text{ kHz}$
		—	103.5	—		$V_{REF} = 5\text{V}$, $f_{IN} = 10\text{ kHz}$
		—	97.4	—		$V_{REF} = 2.5\text{V}$, $f_{IN} = 10\text{ kHz}$
		MCP33111D-10: 12-bit ADC				
		—	99.3	—	dBc	$V_{REF} = 5\text{V}$, $f_{IN} = 1\text{ kHz}$
		—	97.7	—		$V_{REF} = 2.5\text{V}$, $f_{IN} = 1\text{ kHz}$
		—	99.3	—		$V_{REF} = 5\text{V}$, $f_{IN} = 10\text{ kHz}$
		—	97.2	—		$V_{REF} = 2.5\text{V}$, $f_{IN} = 10\text{ kHz}$
		Total Harmonic Distortion (first five harmonics)	THD	MCP33131D-10: 16-bit ADC		
—	-100.4			—	dBc	$V_{REF} = 5\text{V}$, $f_{IN} = 1\text{ kHz}$
—	-95.4			—		$V_{REF} = 2.5\text{V}$, $f_{IN} = 1\text{ kHz}$
—	-99.3			—		$V_{REF} = 5\text{V}$, $f_{IN} = 10\text{ kHz}$
—	-95.4			—		$V_{REF} = 2.5\text{V}$, $f_{IN} = 10\text{ kHz}$
MCP33121D-10: 14-bit ADC						
—	-100.1			—	dBc	$V_{REF} = 5\text{V}$, $f_{IN} = 1\text{ kHz}$
—	-95.3			—		$V_{REF} = 2.5\text{V}$, $f_{IN} = 1\text{ kHz}$
—	-99.2			—		$V_{REF} = 5\text{V}$, $f_{IN} = 10\text{ kHz}$
—	-95.3			—		$V_{REF} = 2.5\text{V}$, $f_{IN} = 10\text{ kHz}$
MCP33111D-10: 12-bit ADC						
—	-97.5			—	dBc	$V_{REF} = 5\text{V}$, $f_{IN} = 1\text{ kHz}$
—	-94.4			—		$V_{REF} = 2.5\text{V}$, $f_{IN} = 1\text{ kHz}$
—	-96.7			—		$V_{REF} = 5\text{V}$, $f_{IN} = 10\text{ kHz}$
—	-94.4			—		$V_{REF} = 2.5\text{V}$, $f_{IN} = 10\text{ kHz}$

- Note**
- 1: This parameter is ensured by design and not 100% tested.
 - 2: This parameter is ensured by characterization and not 100% tested.
 - 3: Decoupling capacitor is recommended on the following pins:
 (a) AV_{DD} pin: 1 μF ceramic capacitor, (b) DV_{IO} pin: 0.1 μF ceramic capacitor, (c) V_{REF} pin: 10 μF tantalum capacitor.
 - 4: Differential Input Full-Scale Range (FSR) = $2 \times V_{REF}$
 - 5: PSRR (dB) = $-20 \log(DV_{OUT}/AV_{DD})$, where DV_{OUT} = change in conversion result.
 - 6: ENOB = $(\text{SINAD} - 1.76)/6.02$

MCP33131D/21D/11D-10

TABLE 1-1: KEY ELECTRICAL CHARACTERISTICS (CONTINUED)

Electrical Specifications: Unless otherwise specified, all parameters apply for $T_A = -40^\circ\text{C}$ to $+85^\circ\text{C}$, $AV_{DD} = 1.8\text{V}$, $DV_{IO} = 3.3\text{V}$, $V_{REF} = 5\text{V}$, $\text{GND} = 0\text{V}$, Differential Analog Input (V_{IN}) = -1 dBFS sine wave, $f_{IN} = 10\text{ kHz}$, SPI Clock Input (SCLK) = 60 MHz, Sample Rate (f_S) = 1 Msps.						
Parameters	Sym.	Min.	Typ.	Max.	Units	Conditions
System Self-Calibration						
Self-Calibration Time	t_{CAL}	—	500	620	ms	(Note 2)
Number of SCLK Clocks for Recalibrate Command	ReCal_{NSCLK}	—	1024	—	clocks	Includes clocks for data bits
External Clock Frequency and Serial Interface Timing Information: See Table 1-2						
Digital Inputs/Outputs						
High-level Input voltage	V_{IH}	$0.7 * DV_{IO}$	—	$DV_{IO} + 0.3$	V	$DV_{IO} \geq 2.3\text{V}$
		$0.9 * DV_{IO}$	—	$DV_{IO} + 0.3$	V	$DV_{IO} < 2.3\text{V}$
Low-level input voltage	V_{IL}	-0.3	—	$0.3 * DV_{IO}$	V	$DV_{IO} \geq 2.3\text{V}$
		-0.3	—	$0.2 * DV_{IO}$	V	$DV_{IO} < 2.3\text{V}$
Hysteresis of Schmitt Trigger Inputs	V_{HYST}	—	$0.2 * DV_{IO}$	—	V	All digital inputs
Low-level output voltage	V_{OL}	—	—	$0.2 * DV_{IO}$	V	$I_{OL} = 500\ \mu\text{A}$ (sink)
High-level output voltage	V_{OH}	$0.8 * DV_{IO}$	—	—	V	$I_{OL} = -500\ \mu\text{A}$ (source)
Input leakage current	I_{LI}	—	—	± 1	μA	$\text{CNVST}/\text{SDI}/\text{SCLK} = \text{GND}$ or DV_{IO}
Output leakage current	I_{LO}	—	—	± 1	μA	Output is high-Z, $\text{SDO} = \text{GND}$ or DV_{IO}
Internal capacitance (all digital inputs and outputs)	C_{INT}	—	7	—	pF	$T_A = 25^\circ\text{C}$ (Note 1)

- Note**
- 1: This parameter is ensured by design and not 100% tested.
 - 2: This parameter is ensured by characterization and not 100% tested.
 - 3: Decoupling capacitor is recommended on the following pins:
(a) AV_{DD} pin: 1 μF ceramic capacitor, (b) DV_{IO} pin: 0.1 μF ceramic capacitor, (c) V_{REF} pin: 10 μF tantalum capacitor.
 - 4: Differential Input Full-Scale Range (FSR) = $2 * V_{REF}$
 - 5: PSRR (dB) = $-20 \log(D_{VOUT}/AV_{DD})$, where D_{VOUT} = change in conversion result.
 - 6: $\text{ENOB} = (\text{SINAD} - 1.76)/6.02$

MCP33131D/21D/11D-10

TABLE 1-2: SERIAL INTERFACE TIMING SPECIFICATIONS

Electrical Specifications: Unless otherwise specified, all parameters apply for $T_A = -40^{\circ}\text{C}$ to $+85^{\circ}\text{C}$, $V_{DD} = 1.8\text{V}$, $DV_{IO} = 3.3\text{V}$, $\text{GND} = 0\text{V}$, Differential Analog Input (A_{IN}) = -1 dBFS sine wave, Resolution = 16-bit (MCP33131D-10), $f_{IN} = 10\text{ kHz}$, Sample Rate (f_S) = 1 Msps, $+25^{\circ}\text{C}$ is applied for typical value. All timings are measured at 50%. See [Figure 1-1](#) for timing diagram.

Parameters	Symbol	Min.	Typ.	Max.	Units	Conditions
Serial Clock frequency	f_{SCLK}	—	—	100	MHz	See t_{SCLK} specification
SCLK Period	t_{SCLK}	10	—	—	ns	$DV_{IO} \geq 3.3\text{V}$, $f_{\text{SCLK}} = 100\text{ MHz}$ (Max)
		12	—	—	ns	$DV_{IO} \geq 2.3\text{V}$, $f_{\text{SCLK}} = 83.3\text{ MHz}$ (Max)
		16	—	—	ns	$DV_{IO} \geq 1.7\text{V}$, $f_{\text{SCLK}} = 62.5\text{ MHz}$ (Max)
SCLK Low Time	$t_{\text{SCLK_L}}$	3	—	—	ns	$DV_{IO} \geq 1.7\text{V}$
SCLK High Time	$t_{\text{SCLK_H}}$	3	—	—	ns	$DV_{IO} \geq 2.3\text{V}$
		4.5	—	—	ns	$DV_{IO} \geq 1.7\text{V}$
Output Valid from SCLK Low	t_{DO}	—	—	9.5	ns	$DV_{IO} \geq 3.3\text{V}$
		—	—	12	ns	$DV_{IO} \geq 2.3\text{V}$
		—	—	16	ns	$DV_{IO} \geq 1.7\text{V}$
Quiet time	t_{QUIET}	10	—	—	ns	
3-Wire Operation:						
SDI Valid Setup time	$t_{\text{SU_SDIH_CNV}}$	5	—	—	ns	SDI High to CNVST Rising Edge
CNVST Pulse Width High Time	t_{CNVH}	10	—	—	ns	
Output Enable Time	t_{EN}	—	—	10	ns	$DV_{IO} \geq 2.3\text{V}$
		—	—	15	ns	$DV_{IO} \geq 1.7\text{V}$
Output Disable Time	t_{DIS}	—	—	15	ns	(Note 2), (Note 4)
Input Acquisition Time	t_{ACQ}	290	—	—	ns	See Sampling Dynamics in Table 1-1
Data Conversion Time	t_{CNV}	—	560	710	ns	
Time between Conversions	t_{CYC}	1	—	—	μs	

- Note**
- 1: This parameter is ensured by design and not 100% tested.
 - 2: This parameter is ensured by characterization and not 100% tested.
 - 3: CNVST low to valid MSB bit at SDO.
 - 4: CNVST high or last SCLK falling edge to SDO High-Z state.

TABLE 1-3: TEMPERATURE CHARACTERISTICS

Electrical Specifications: Unless otherwise specified, all parameters apply for $T_A = -40^{\circ}\text{C}$ to $+85^{\circ}\text{C}$, $V_{DD} = 1.8\text{V}$, $DV_{IO} = 3.3\text{V}$, $\text{GND} = 0\text{V}$, $V_{\text{REF}} = 5\text{V}$, Analog Input (A_{IN}) = -1 dBFS sine wave, $f_{IN} = 10\text{ kHz}$, SPI Clock Input = 60 MHz, Sample Rate (f_S) = 1 Msps.

Parameters	Symbol	Min.	Typ.	Max.	Units	Conditions
Temperature Ranges						
Operating Temperature Range	T_A	-40	—	+85	$^{\circ}\text{C}$	(Note 1)
Storage Temperature Range	T_A	-65	—	+150	$^{\circ}\text{C}$	(Note 1)
Thermal Package Resistance						
Thermal Resistance, MSOP-10	θ_{JA}	—	202	—	$^{\circ}\text{C/W}$	
Thermal Resistance, TDFN-10	θ_{JA}	—	68	—	$^{\circ}\text{C/W}$	(Note 2)

- Note**
- 1: The internal junction temperature (T_J) must not exceed the absolute maximum specification of $+150^{\circ}\text{C}$.
 - 2: Contact Microchip Technology Inc. for availability.

MCP33131D/21D/11D-10

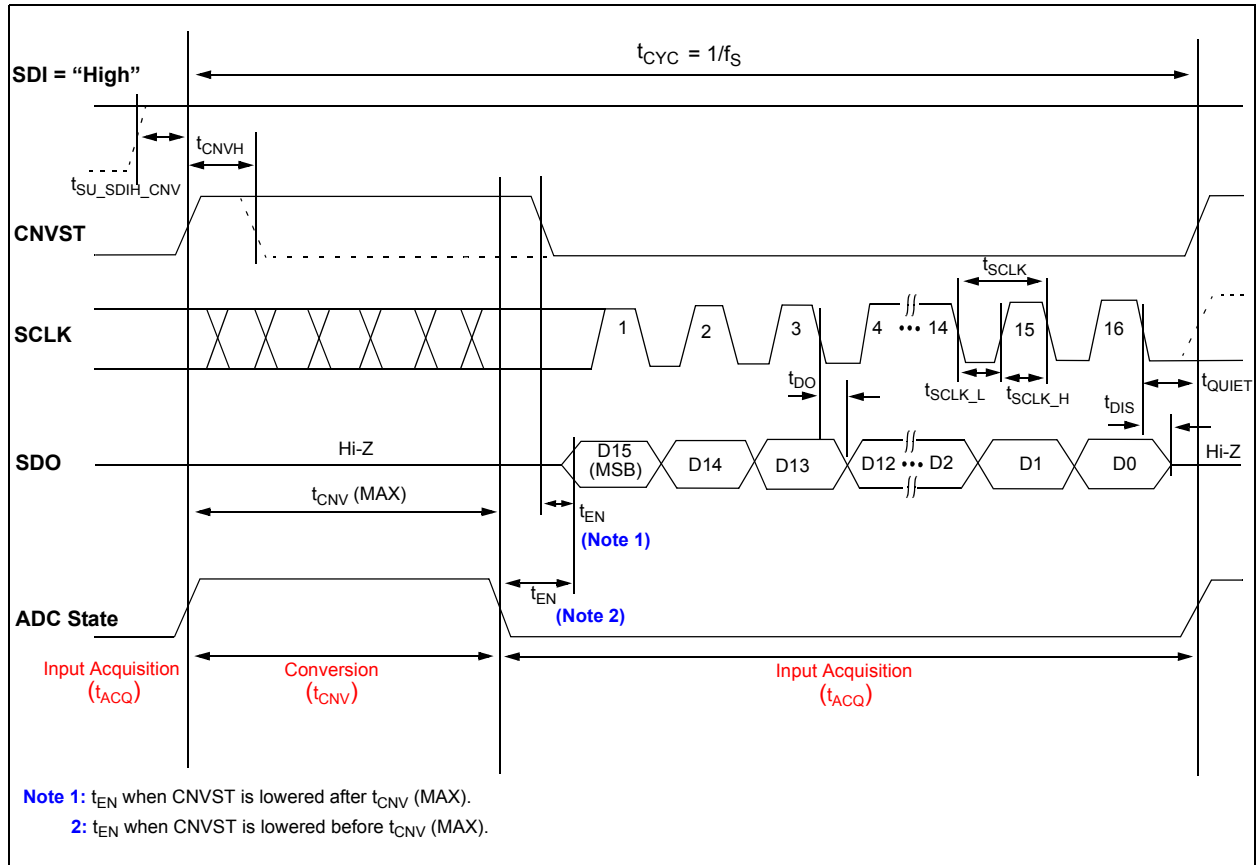

FIGURE 1-1: Interface Timing Diagram (16-bit device). CNVST is used as chip select. See Figure 7-2 for More Details.

MCP33131D/21D/11D-10

NOTES:

MCP33131D/21D/11D-10

2.0 TYPICAL PERFORMANCE CURVES FOR MCP33131D-10

Note: The graphs and tables provided following this note are a statistical summary based on a limited number of samples and are provided for informational purposes only. The performance characteristics listed herein are not tested or guaranteed. In some graphs or tables, the data presented may be outside the specified operating range (e.g., outside specified power supply range) and therefore outside the warranted range.

Note: Unless otherwise specified, all parameters apply for $T_A = +25^\circ\text{C}$, $AV_{DD} = 1.8\text{V}$, $DV_{IO} = 3.3\text{V}$, $V_{REF} = 5\text{V}$, $\text{GND} = 0\text{V}$, Differential Analog Input (V_{IN}) = -1 dBFS, $f_{IN} = 10\text{ kHz}$, SPI Clock Input = 60 MHz, Sample Rate (f_S) = 1 Msp. Device = MCP33131D-10.

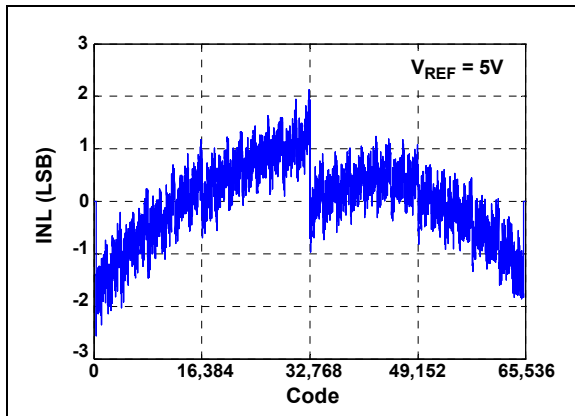

FIGURE 2-1: INL vs. Output Code.

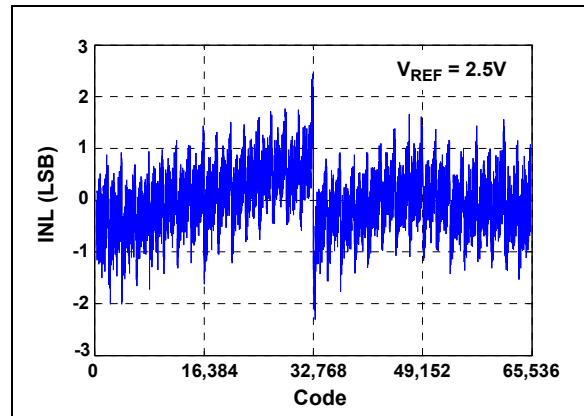

FIGURE 2-4: INL vs. Output Code.

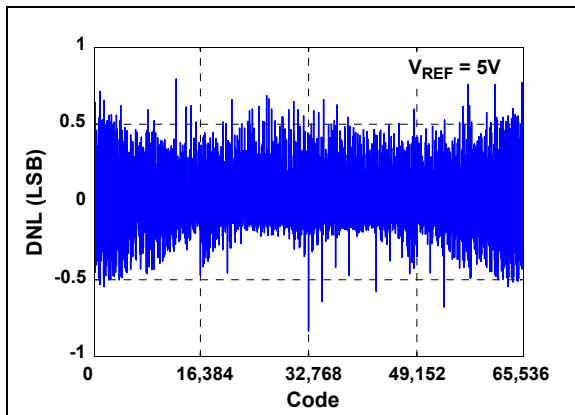

FIGURE 2-2: DNL vs. Output Code.

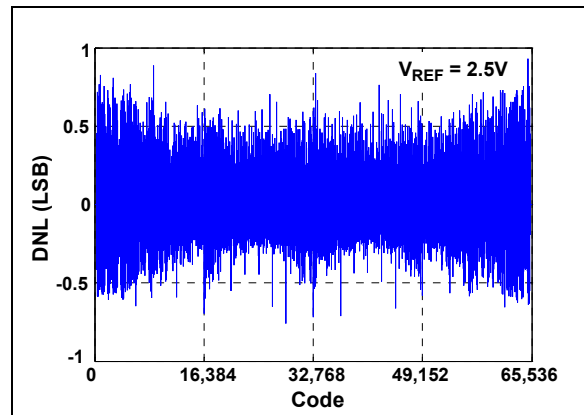

FIGURE 2-5: DNL vs. Output Code.

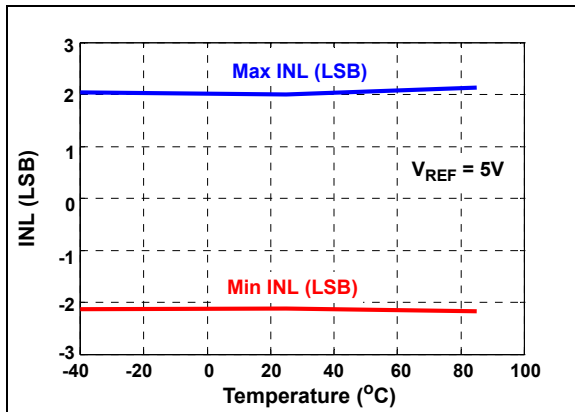

FIGURE 2-3: INL vs. Temperature.

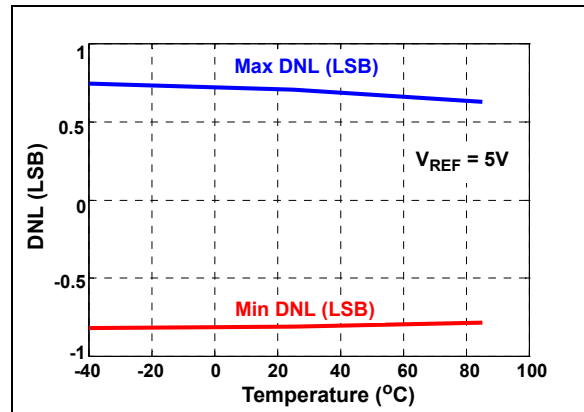

FIGURE 2-6: DNL vs. Temperature.

MCP33131D/21D/11D-10

Note: Unless otherwise specified, all parameters apply for $T_A = +25^\circ\text{C}$, $V_{DD} = 1.8\text{V}$, $DV_{IO} = 3.3\text{V}$, $V_{REF} = 5\text{V}$, $\text{GND} = 0\text{V}$, Differential Analog Input (V_{IN}) = -1 dBFS , $f_{IN} = 10\text{ kHz}$, SPI Clock Input = 60 MHz , Sample Rate (f_s) = 1 Msp . Device = **MCP33131D-10**.

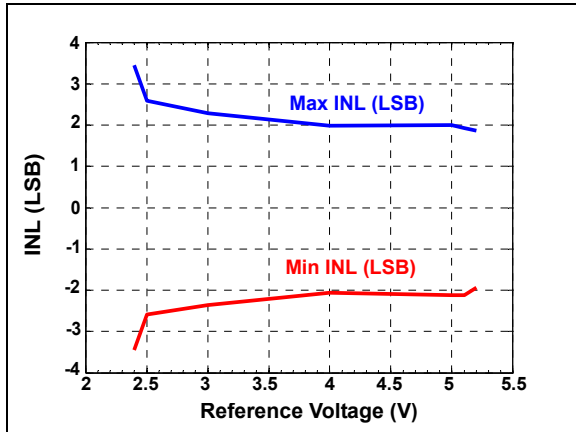

FIGURE 2-7: INL vs. Reference Voltage.

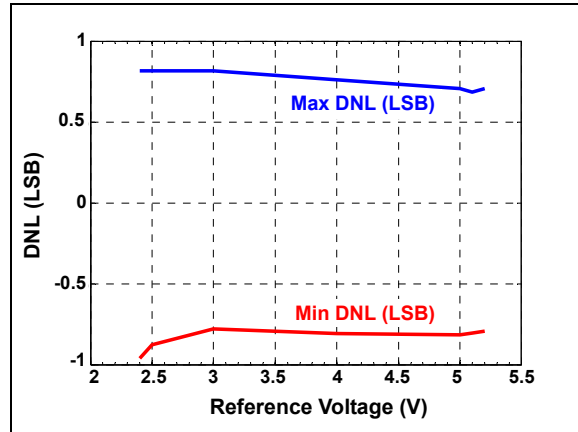

FIGURE 2-10: DNL vs. Reference Voltage.

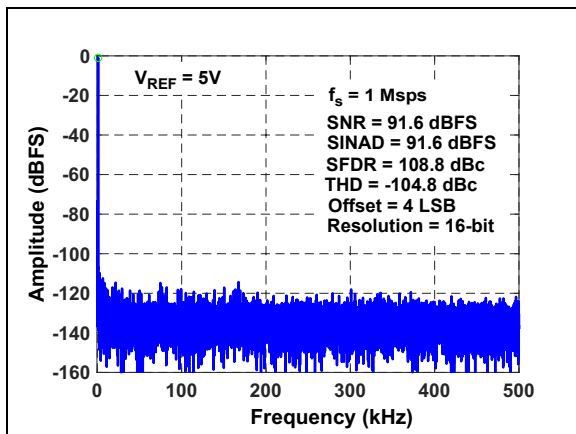

FIGURE 2-8: FFT for 1 kHz Input Signal: $f_s = 1\text{ Msp}$, $V_{IN} = -1\text{ dBFS}$, $V_{REF} = 5\text{V}$.

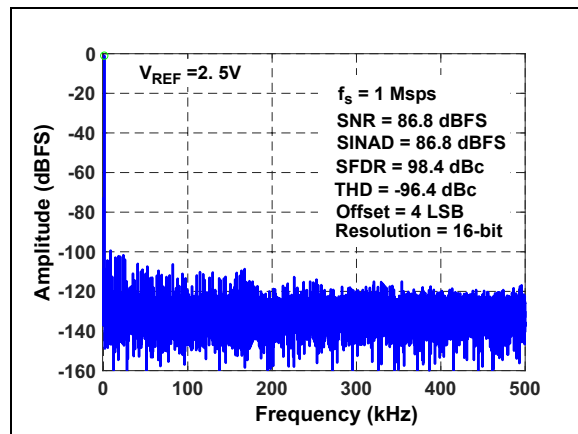

FIGURE 2-11: FFT for 1 kHz Input Signal: $f_s = 1\text{ Msp}$, $V_{IN} = -1\text{ dBFS}$, $V_{REF} = 2.5\text{V}$.

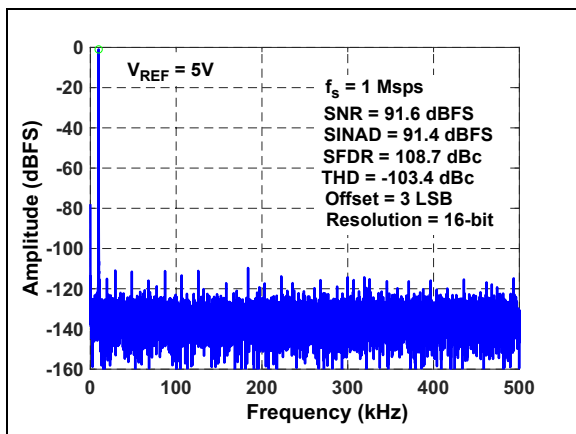

FIGURE 2-9: FFT for 10 kHz Input Signal: $f_s = 1\text{ Msp}$, $V_{IN} = -1\text{ dBFS}$, $V_{REF} = 5\text{V}$.

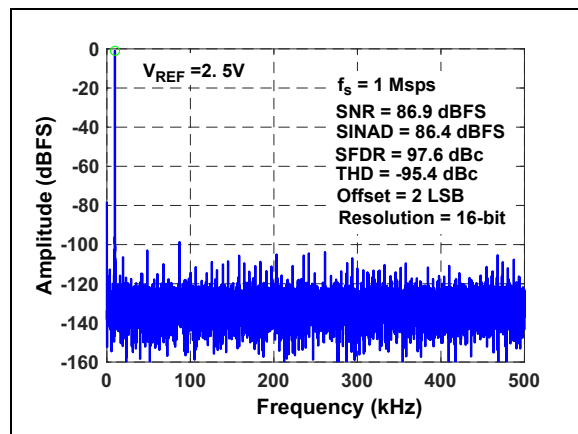

FIGURE 2-12: FFT for 10 kHz Input Signal: $f_s = 1\text{ Msp}$, $V_{IN} = -1\text{ dBFS}$, $V_{REF} = 2.5\text{V}$.

MCP33131D/21D/11D-10

Note: Unless otherwise specified, all parameters apply for $T_A = +25^\circ\text{C}$, $AV_{DD} = 1.8\text{V}$, $DV_{IO} = 3.3\text{V}$, $V_{REF} = 5\text{V}$, $\text{GND} = 0\text{V}$, Differential Analog Input (V_{IN}) = -1 dBFS, $f_{IN} = 10\text{ kHz}$, SPI Clock Input = 60 MHz, Sample Rate (f_S) = 1 Msp. Device = MCP33131D-10.

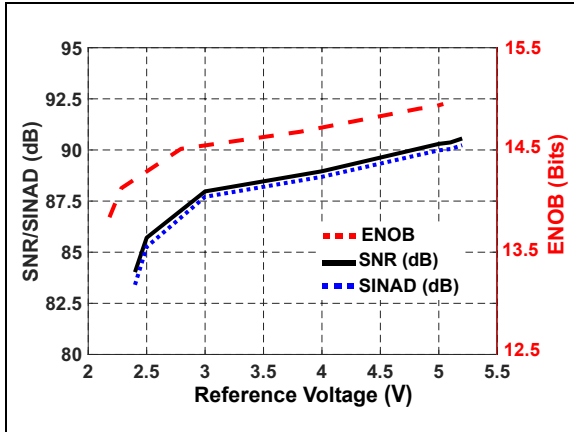

FIGURE 2-13: SNR/SINAD/ENOB vs. V_{REF}

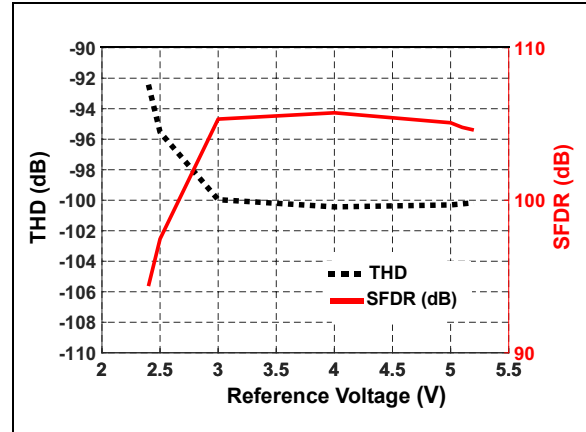

FIGURE 2-16: SFDR/THD vs. V_{REF}

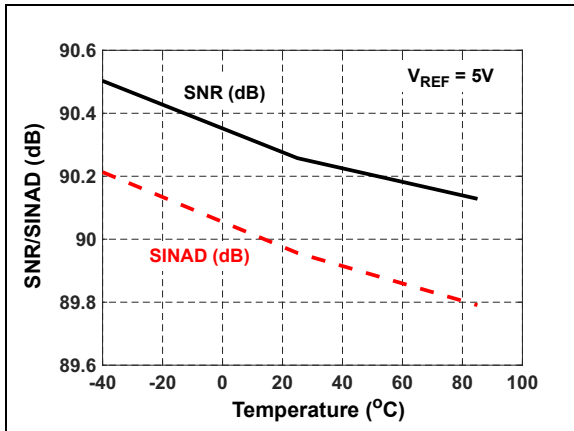

FIGURE 2-14: SNR/SINAD vs. Temperature: $V_{REF} = 5\text{V}$.

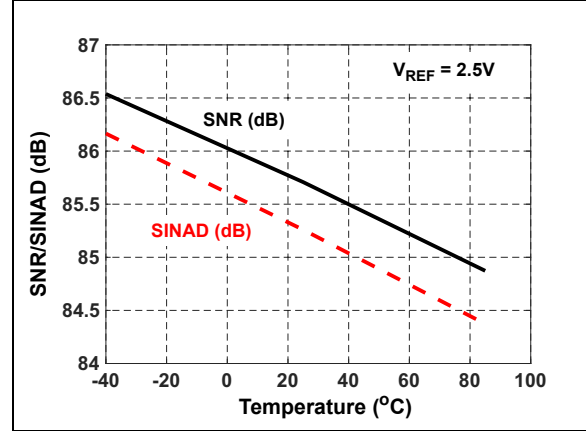

FIGURE 2-17: SNR/SINAD vs. Temperature: $V_{REF} = 2.5\text{V}$.

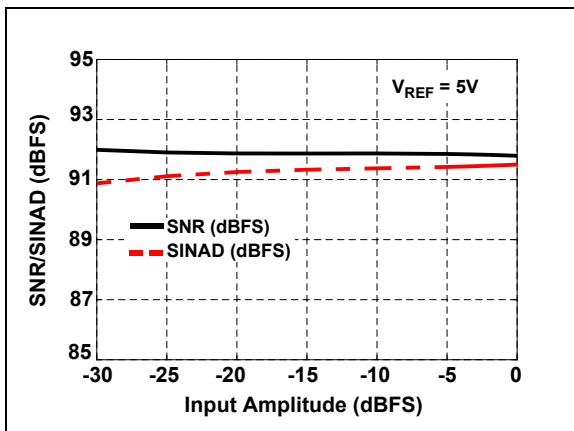

FIGURE 2-15: SNR/SINAD vs. Input Amplitude: $f_{IN} = 10\text{ kHz}$.

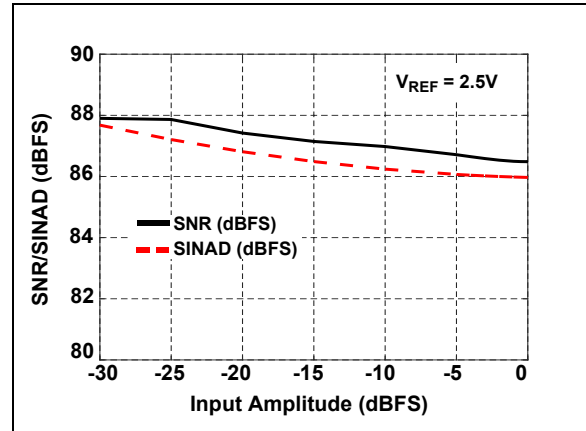

FIGURE 2-18: SNR/SINAD vs. Input Amplitude: $f_{IN} = 10\text{ kHz}$.

MCP33131D/21D/11D-10

Note: Unless otherwise specified, all parameters apply for $T_A = +25^\circ\text{C}$, $AV_{DD} = 1.8\text{V}$, $DV_{IO} = 3.3\text{V}$, $V_{REF} = 5\text{V}$, $GND = 0\text{V}$, Differential Analog Input (V_{IN}) = -1 dBFS , $f_{IN} = 10\text{ kHz}$, SPI Clock Input = 60 MHz , Sample Rate (f_S) = 1 Msp s. Device = [MCP33131D-10](#).

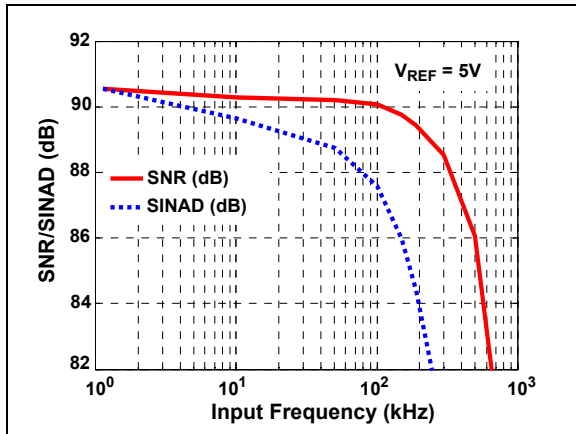

FIGURE 2-19: SNR/SINAD vs. Input Frequency: $V_{IN} = -1\text{ dBFS}$.

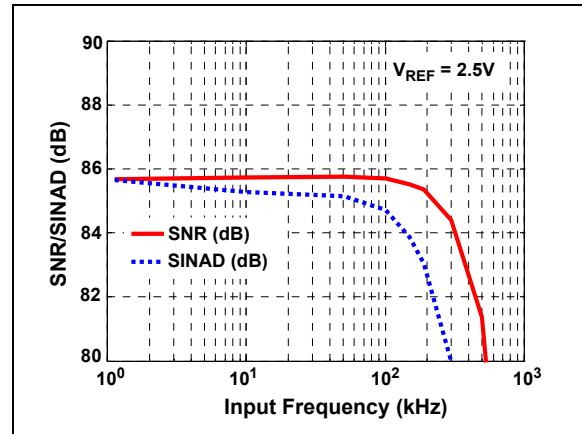

FIGURE 2-22: SNR/SINAD vs. Input Frequency: $V_{IN} = -1\text{ dBFS}$.

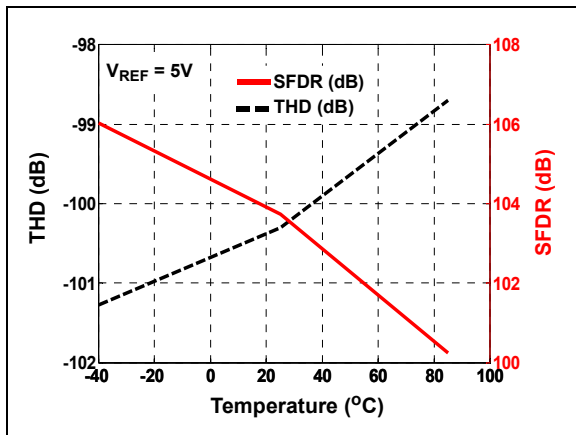

FIGURE 2-20: THD/SFDR vs. Temperature: $V_{REF} = 5\text{V}$.

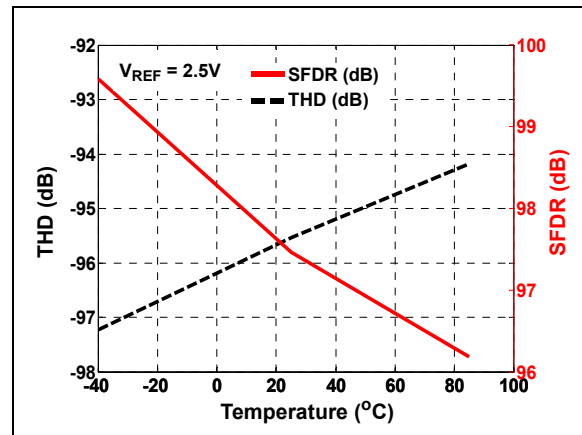

FIGURE 2-23: THD/SFDR vs. Temperature: $V_{REF} = 2.5\text{V}$.

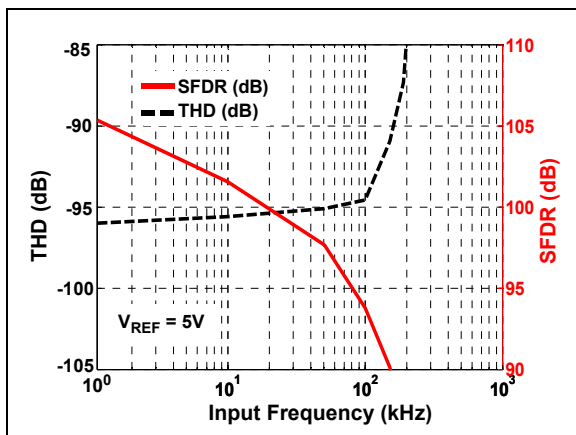

FIGURE 2-21: THD/SFDR vs. Input Frequency: $V_{REF} = 5\text{V}$.

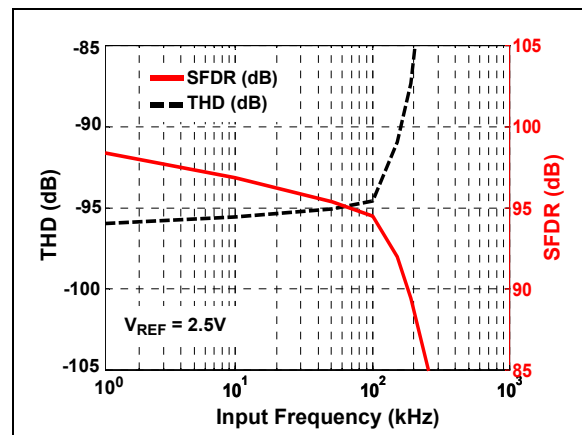

FIGURE 2-24: THD/SFDR vs. Input Frequency: $V_{REF} = 2.5\text{V}$.

MCP33131D/21D/11D-10

Note: Unless otherwise specified, all parameters apply for $T_A = +25^\circ\text{C}$, $AV_{DD} = 1.8\text{V}$, $DV_{IO} = 3.3\text{V}$, $V_{REF} = 5\text{V}$, $\text{GND} = 0\text{V}$, Differential Analog Input (V_{IN}) = -1 dBFS , $f_{IN} = 10\text{ kHz}$, SPI Clock Input = 60 MHz , Sample Rate (f_S) = 1 Msps . Device = [MCP33131D-10](#).

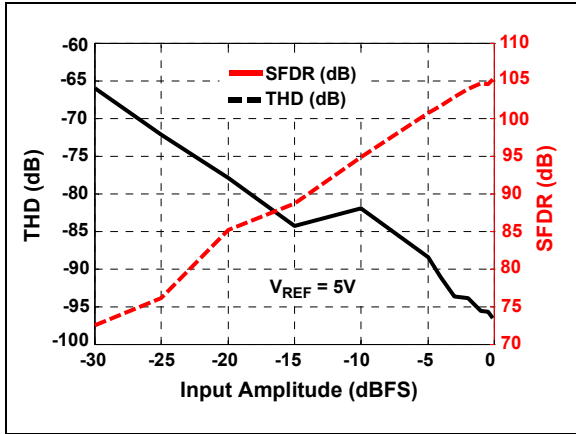

FIGURE 2-25: THD/SFDR vs. Input Amplitude: $V_{REF} = 5\text{V}$.

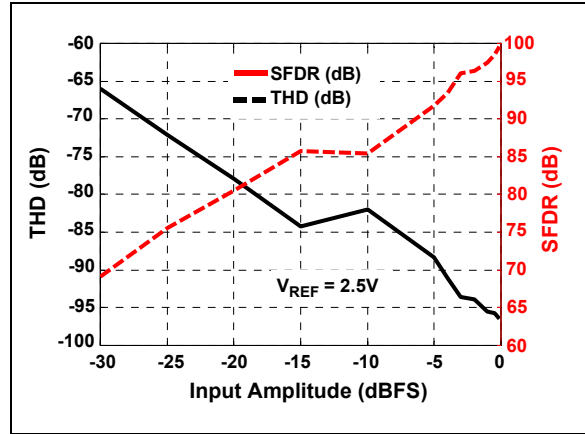

FIGURE 2-28: THD/SFDR vs. Input Amplitude: $V_{REF} = 2.5\text{V}$.

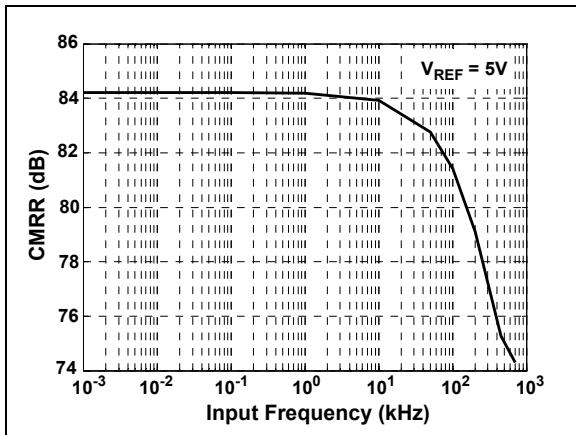

FIGURE 2-26: CMRR vs. Input Frequency: $V_{REF} = 5\text{V}$.

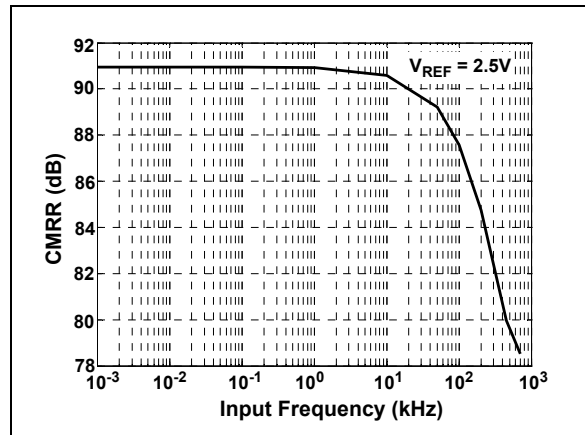

FIGURE 2-29: CMRR vs. Input Frequency: $V_{REF} = 2.5\text{V}$.

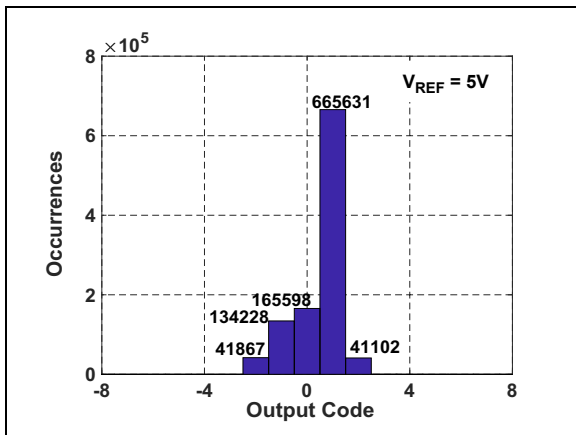

FIGURE 2-27: Shorted Input Histogram: $V_{REF} = 5\text{V}$.

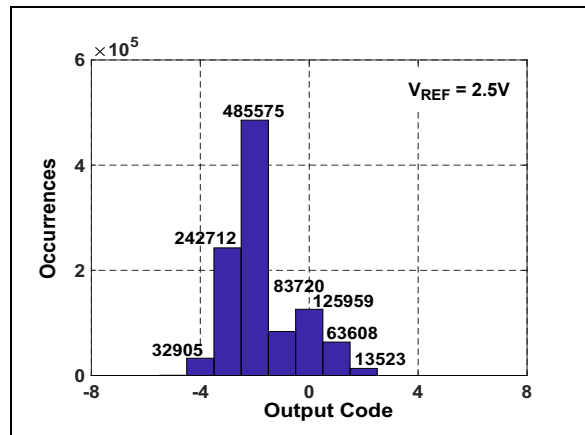

FIGURE 2-30: Shorted Input Histogram: $V_{REF} = 2.5\text{V}$.

MCP33131D/21D/11D-10

Note: Unless otherwise specified, all parameters apply for $T_A = +25^\circ\text{C}$, $AV_{DD} = 1.8\text{V}$, $DV_{IO} = 3.3\text{V}$, $V_{REF} = 5\text{V}$, $\text{GND} = 0\text{V}$, Differential Analog Input (V_{IN}) = -1 dBFS, $f_{IN} = 10\text{ kHz}$, SPI Clock Input = 60 MHz, Sample Rate (f_S) = 1 Msps. Device = [MCP33131D-10](#).

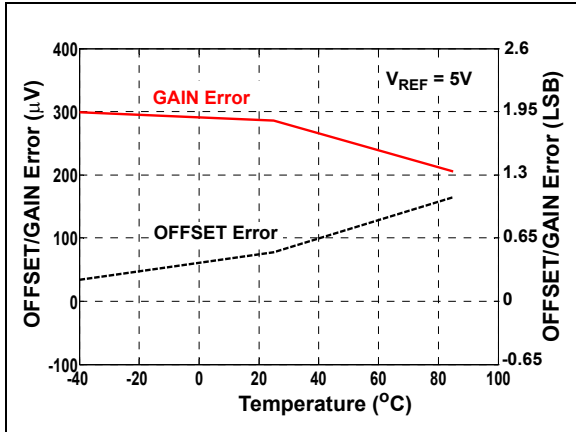

FIGURE 2-31: Offset and Gain Error vs. Temperature: $V_{REF} = 5\text{V}$.

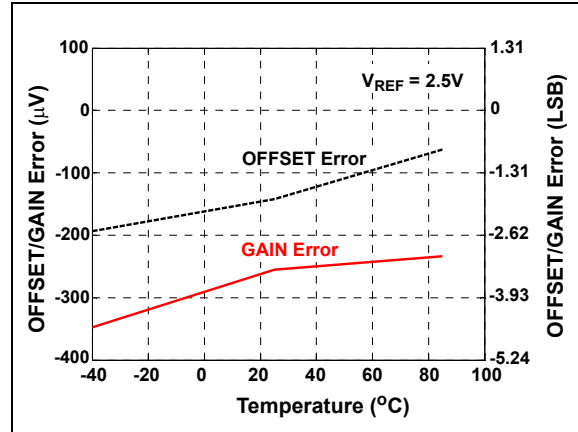

FIGURE 2-33: Offset and Gain Error vs. Temperature: $V_{REF} = 2.5\text{V}$.

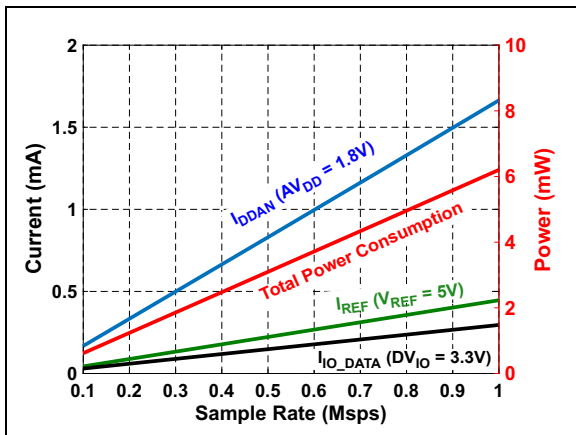

FIGURE 2-32: Power Consumption vs. Sample Rate (Throughput): $C_{LOAD_SDO} = 20\text{ pF}$.

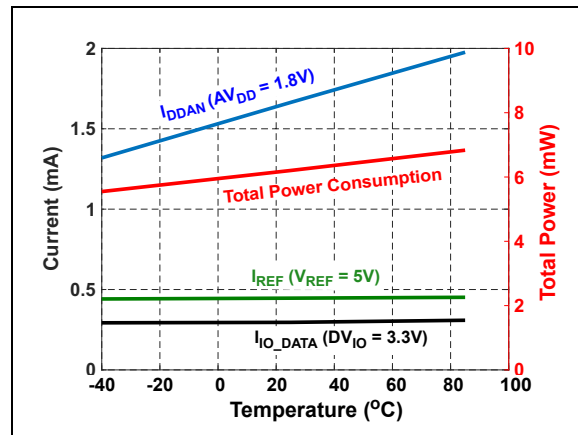

FIGURE 2-34: Power Consumption vs. Temperature: $C_{LOAD_SDO} = 20\text{ pF}$.

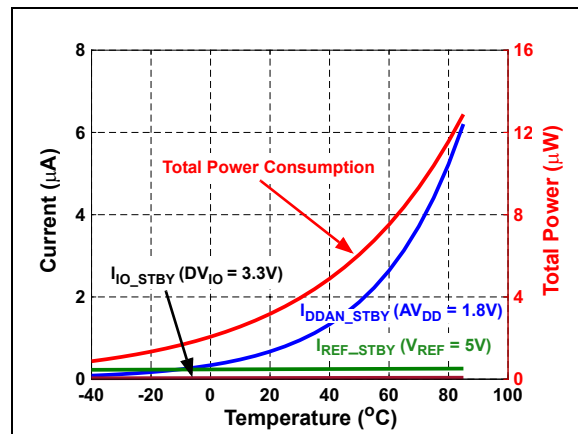

FIGURE 2-35: Power Consumption vs. Temperature during Shutdown.

3.0 TYPICAL PERFORMANCE CURVES FOR MCP33121D-10

Note: The graphs and tables provided following this note are a statistical summary based on a limited number of samples and are provided for informational purposes only. The performance characteristics listed herein are not tested or guaranteed. In some graphs or tables, the data presented may be outside the specified operating range (e.g., outside specified power supply range) and therefore outside the warranted range.

Note: Unless otherwise specified, all parameters apply for $T_A = +25^\circ\text{C}$, $V_{DD} = 1.8\text{V}$, $DV_{IO} = 3.3\text{V}$, $V_{REF} = 5\text{V}$, $\text{GND} = 0\text{V}$, Differential Analog Input (V_{IN}) = -1 dBFS, $f_{IN} = 10\text{ kHz}$, SPI Clock Input = 60 MHz, Sample Rate (f_S) = 1 Msp. Device = **MCP33121D-10**.

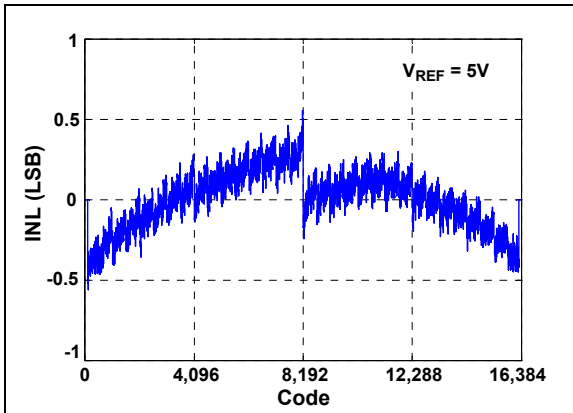

FIGURE 3-1: INL vs. Output Code.

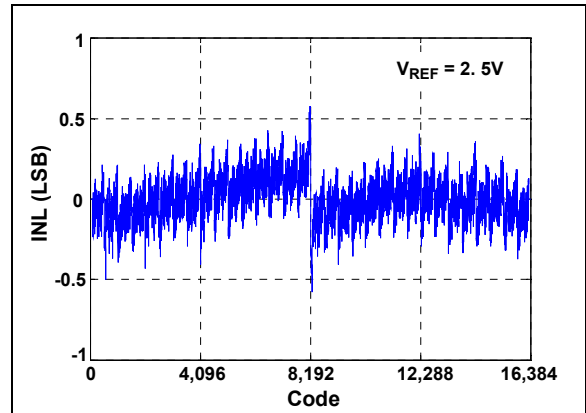

FIGURE 3-4: INL vs. Output Code.

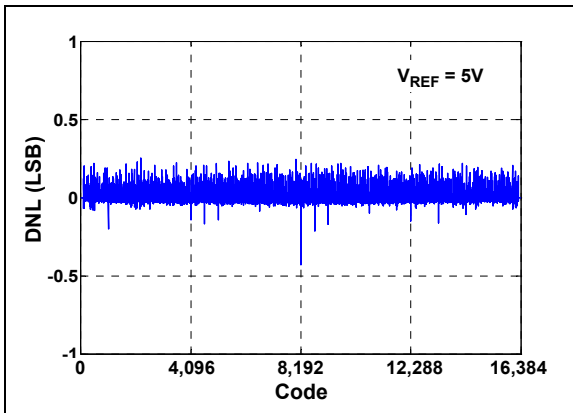

FIGURE 3-2: DNL vs. Output Code.

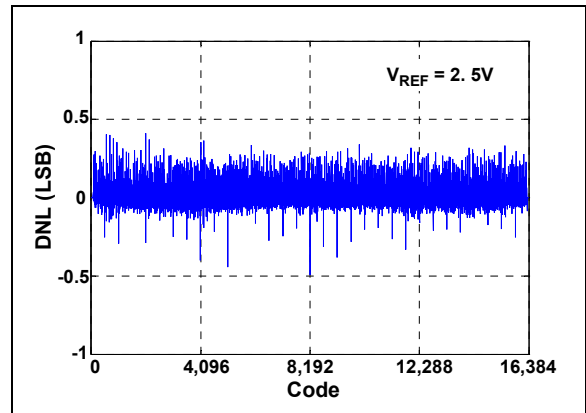

FIGURE 3-5: DNL vs. Output Code.

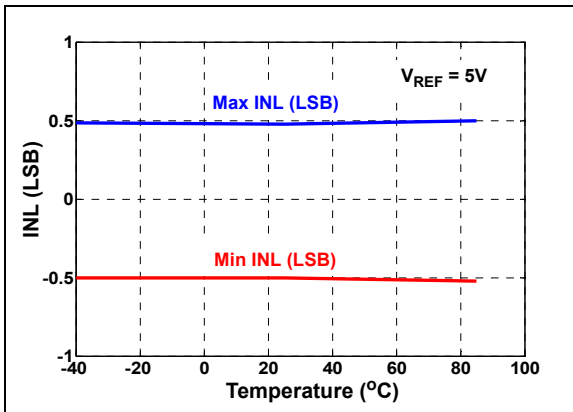

FIGURE 3-3: INL vs. Temperature.

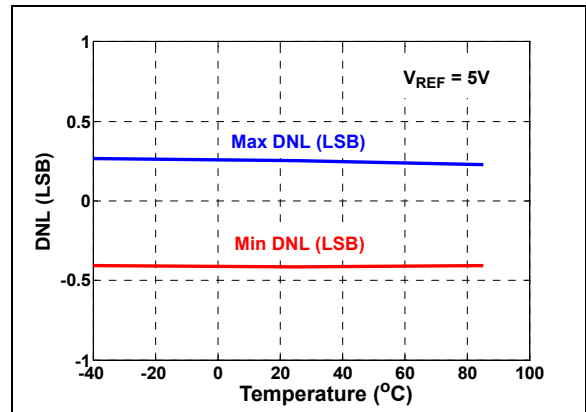

FIGURE 3-6: DNL vs. Temperature.

MCP33131D/21D/11D-10

Note: Unless otherwise specified, all parameters apply for $T_A = +25^\circ\text{C}$, $AV_{DD} = 1.8\text{V}$, $DV_{IO} = 3.3\text{V}$, $V_{REF} = 5\text{V}$, $\text{GND} = 0\text{V}$, Differential Analog Input (V_{IN}) = -1 dBFS, $f_{IN} = 10\text{ kHz}$, SPI Clock Input = 60 MHz, Sample Rate (f_s) = 1 Msp. Device = MCP33121D-10.

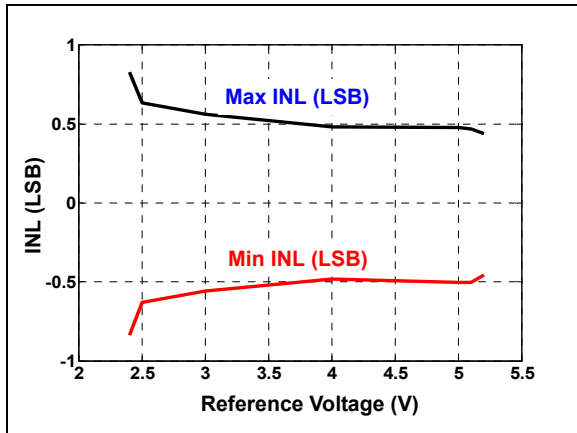

FIGURE 3-7: INL vs. Reference Voltage.

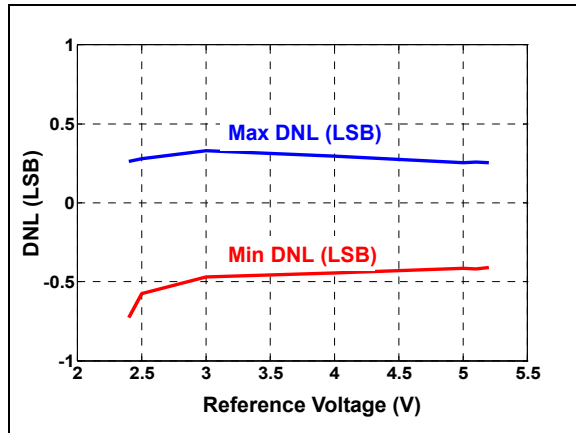

FIGURE 3-10: DNL vs. Reference Voltage.

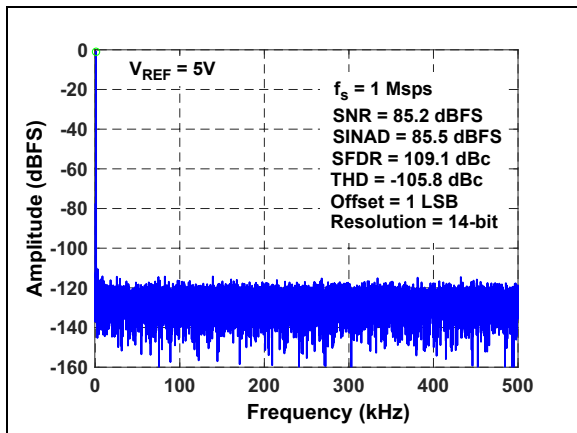

FIGURE 3-8: FFT for 1 kHz Input Signal: $f_s = 1\text{ Msp}$, $V_{IN} = -1\text{ dBFS}$, $V_{REF} = 5\text{V}$.

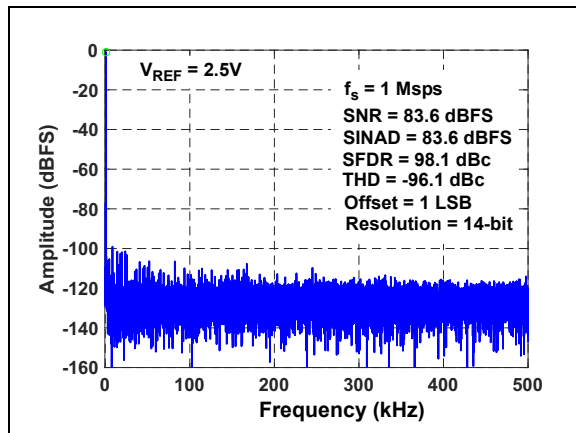

FIGURE 3-11: FFT for 1 kHz Input Signal: $f_s = 1\text{ Msp}$, $V_{IN} = -1\text{ dBFS}$, $V_{REF} = 2.5\text{V}$.

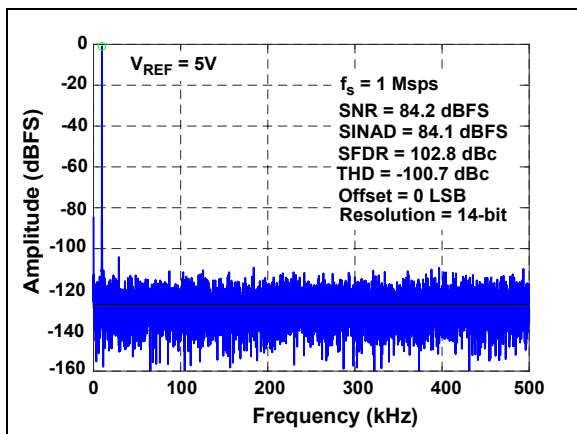

FIGURE 3-9: FFT for 10 kHz Input Signal: $f_s = 1\text{ Msp}$, $V_{IN} = -1\text{ dBFS}$, $V_{REF} = 5\text{V}$.

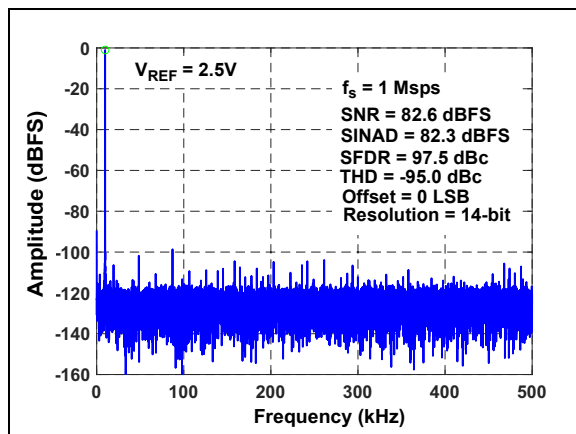

FIGURE 3-12: FFT for 10 kHz Input Signal: $f_s = 1\text{ Msp}$, $V_{IN} = -1\text{ dBFS}$, $V_{REF} = 2.5\text{V}$.

MCP33131D/21D/11D-10

Note: Unless otherwise specified, all parameters apply for $T_A = -40^\circ\text{C}$ to $+85^\circ\text{C}$, $AV_{DD} = 1.8\text{V}$, $DV_{IO} = 3.3\text{V}$, $V_{REF} = 5\text{V}$, $\text{GND} = 0\text{V}$, Differential Analog Input (V_{IN}) = -1 dBFS , $f_{IN} = 10\text{ kHz}$, SPI Clock Input = 60 MHz , Sample Rate (f_S) = 1 Mps . Device = **MCP33121D-10**.

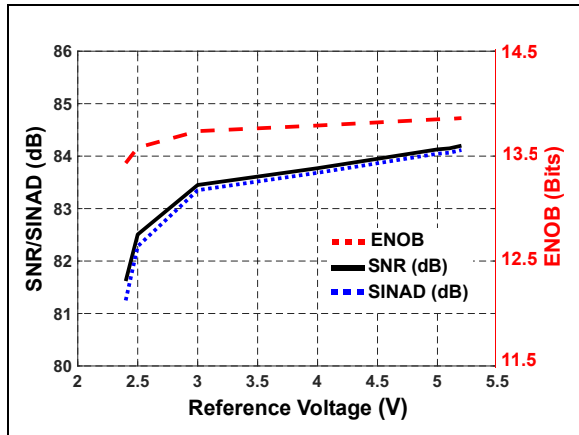

FIGURE 3-13: SNR/SINAD/ENOB vs. V_{REF}

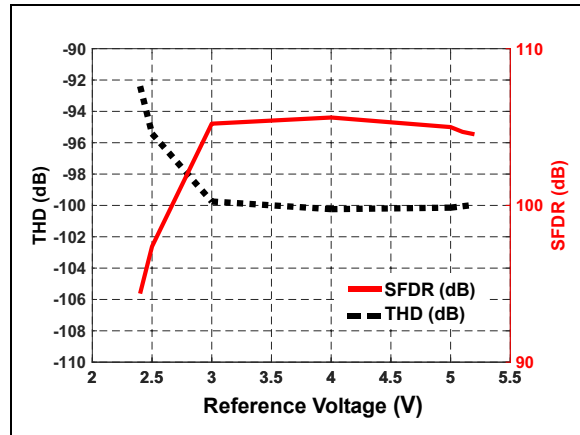

FIGURE 3-16: SFDR/THD vs. V_{REF}

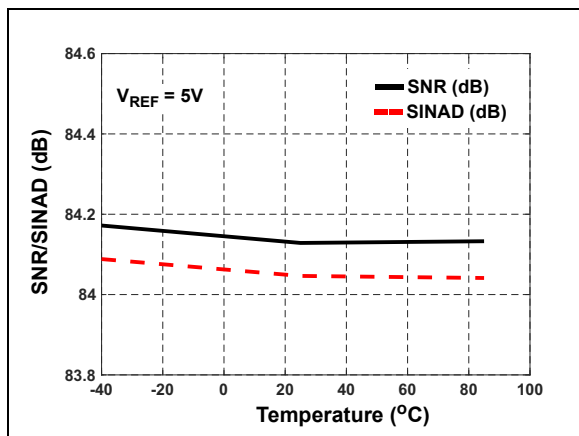

FIGURE 3-14: SNR/SINAD vs. Temperature: $V_{REF} = 5\text{V}$.

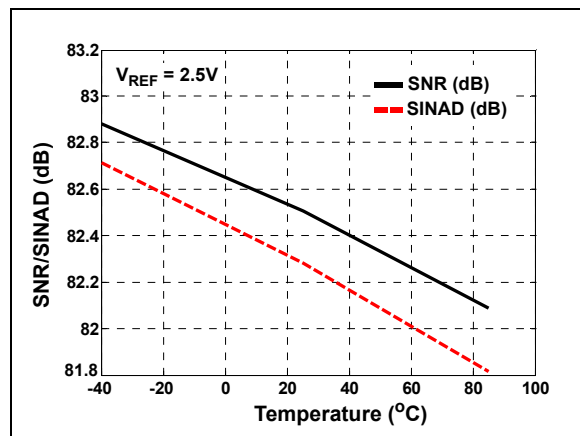

FIGURE 3-17: SNR/SINAD vs. Temperature: $V_{REF} = 2.5\text{V}$.

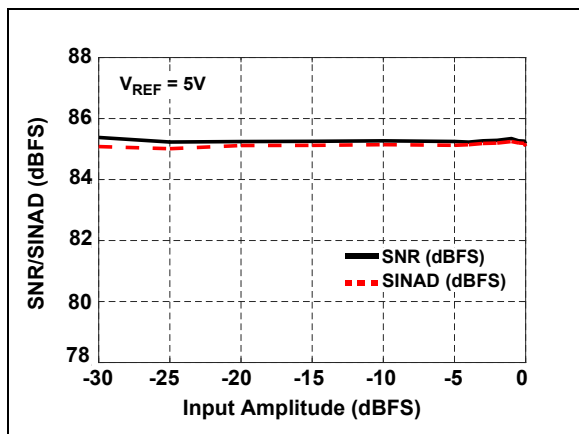

FIGURE 3-15: SNR/SINAD vs. Input Amplitude: $f_{IN} = 10\text{ kHz}$.

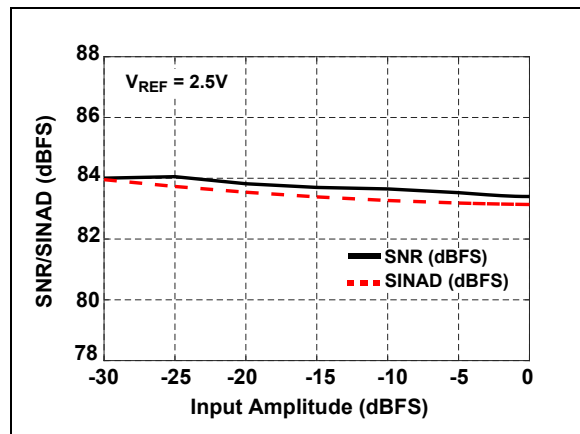

FIGURE 3-18: SNR/SINAD vs. Input Amplitude: $f_{IN} = 10\text{ kHz}$.

MCP33131D/21D/11D-10

Note: Unless otherwise specified, all parameters apply for $T_A = +25^\circ\text{C}$, $V_{DD} = 1.8\text{V}$, $DV_{IO} = 3.3\text{V}$, $V_{REF} = 5\text{V}$, $GND = 0\text{V}$, Differential Analog Input (V_{IN}) = -1 dBFS, $f_{IN} = 10\text{ kHz}$, SPI Clock Input = 60 MHz, Sample Rate (f_S) = 1 Msps. Device = [MCP33121D-10](#).

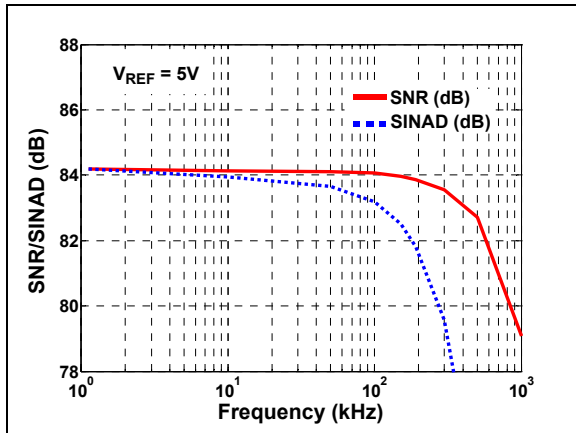

FIGURE 3-19: SNR/SINAD vs. Input Frequency: $V_{IN} = -1\text{ dBFS}$.

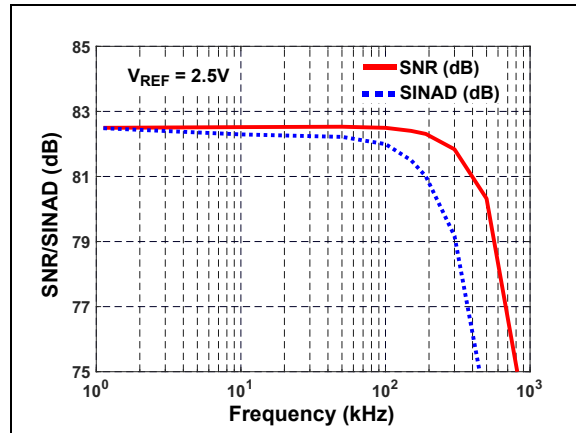

FIGURE 3-22: SNR/SINAD vs. Input Frequency: $V_{IN} = -1\text{ dBFS}$.

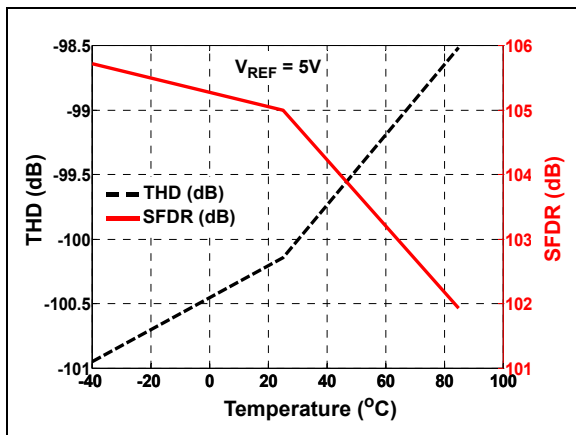

FIGURE 3-20: THD/SFDR vs. Temperature: $V_{REF} = 5\text{V}$.

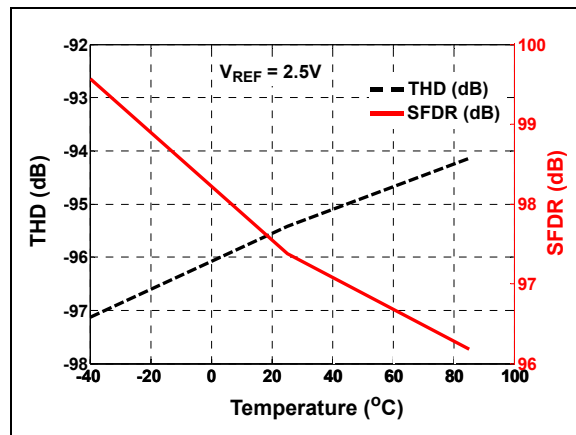

FIGURE 3-23: THD/SFDR vs. Temperature: $V_{REF} = 2.5\text{V}$.

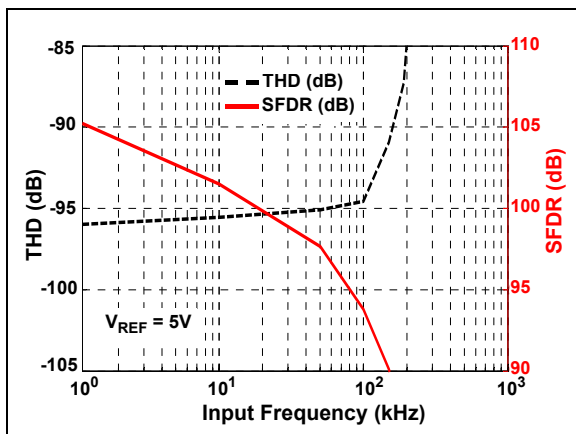

FIGURE 3-21: THD/SFDR vs. Input Frequency: $V_{REF} = 5\text{V}$.

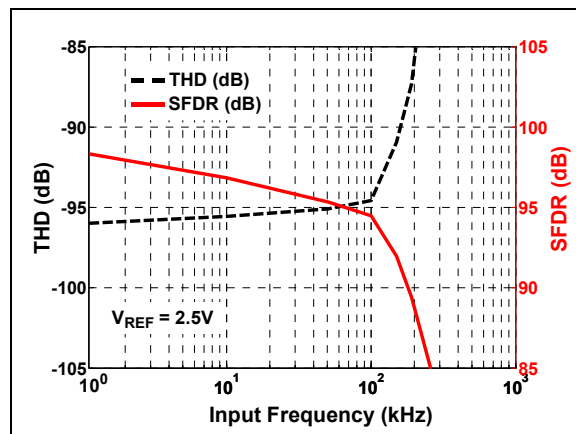

FIGURE 3-24: THD/SFDR vs. Input Frequency: $V_{REF} = 2.5\text{V}$.

MCP33131D/21D/11D-10

Note: Unless otherwise specified, all parameters apply for $T_A = +25^\circ\text{C}$, $AV_{DD} = 1.8\text{V}$, $DV_{IO} = 3.3\text{V}$, $V_{REF} = 5\text{V}$, $\text{GND} = 0\text{V}$, Differential Analog Input (V_{IN}) = -1 dBFS, $f_{IN} = 10\text{ kHz}$, SPI Clock Input = 60 MHz, Sample Rate (f_S) = 1 Msps. Device = MCP33121D-10.

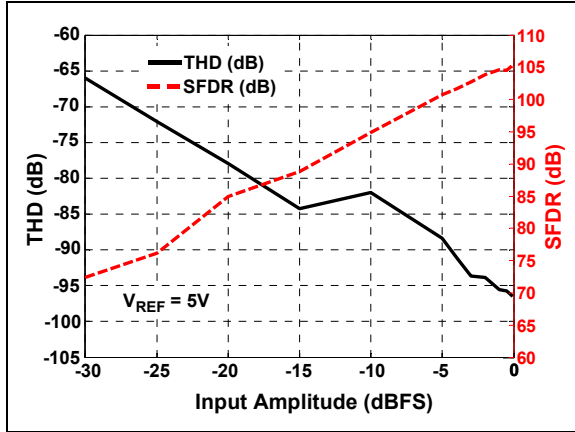

FIGURE 3-25: THD/SFDR vs. Input Amplitude: $V_{REF} = 5\text{V}$.

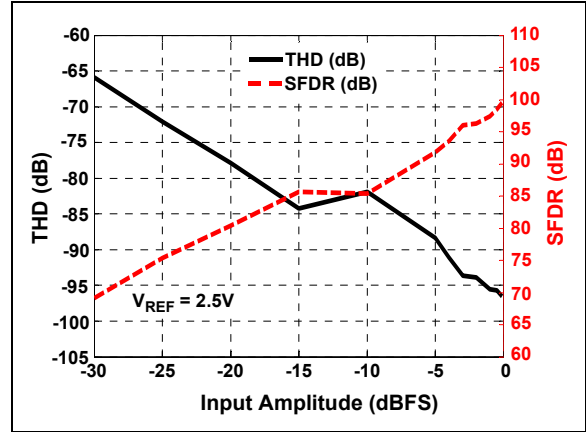

FIGURE 3-28: THD/SFDR vs. Input Amplitude: $V_{REF} = 2.5\text{V}$.

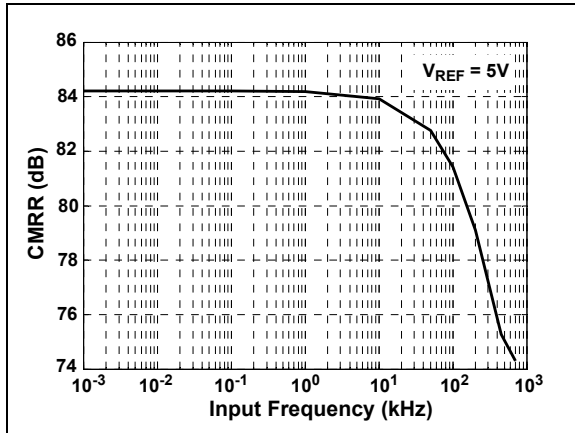

FIGURE 3-26: CMRR vs. Input Frequency: $V_{REF} = 5\text{V}$.

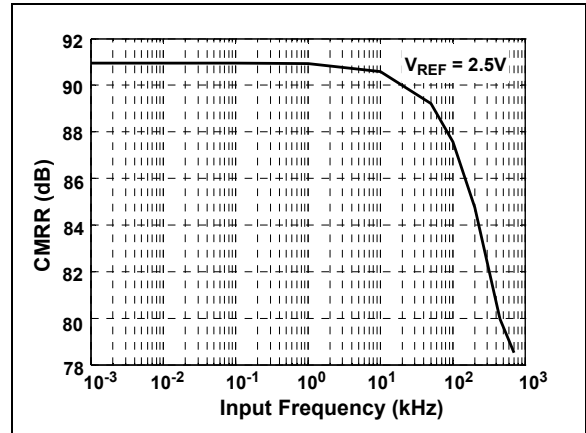

FIGURE 3-29: CMRR vs. Input Frequency: $V_{REF} = 2.5\text{V}$.

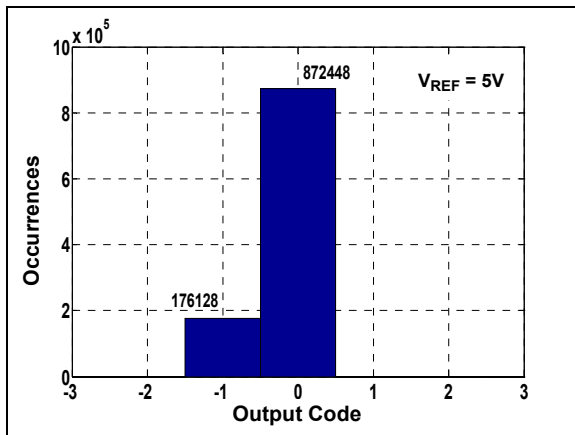

FIGURE 3-27: Shorted Input Histogram: $V_{REF} = 5\text{V}$.

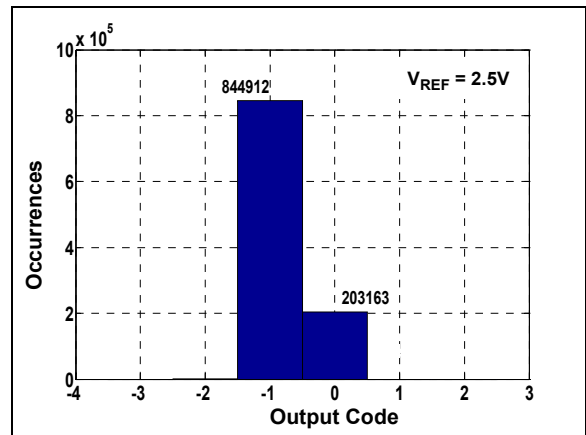

FIGURE 3-30: Shorted Input Histogram: $V_{REF} = 2.5\text{V}$.

MCP33131D/21D/11D-10

Note: Unless otherwise specified, all parameters apply for $T_A = +25^\circ\text{C}$, $AV_{DD} = 1.8\text{V}$, $DV_{IO} = 3.3\text{V}$, $V_{REF} = 5\text{V}$, $\text{GND} = 0\text{V}$, Differential Analog Input (V_{IN}) = -1 dBFS, $f_{IN} = 10\text{ kHz}$, SPI Clock Input = 60 MHz, Sample Rate (f_S) = 1 Msps. Device = [MCP33121D-10](#).

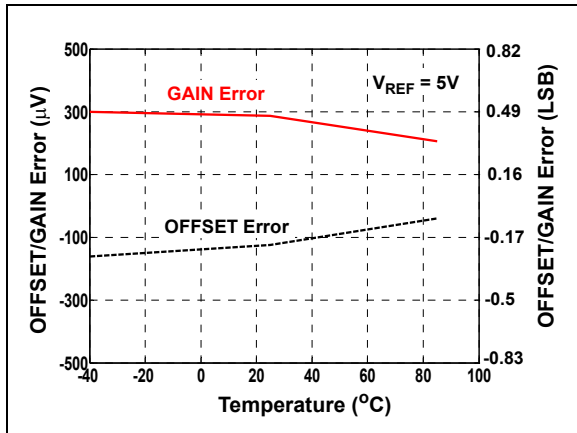

FIGURE 3-31: Offset and Gain Error vs. Temperature: $V_{REF} = 5\text{V}$.

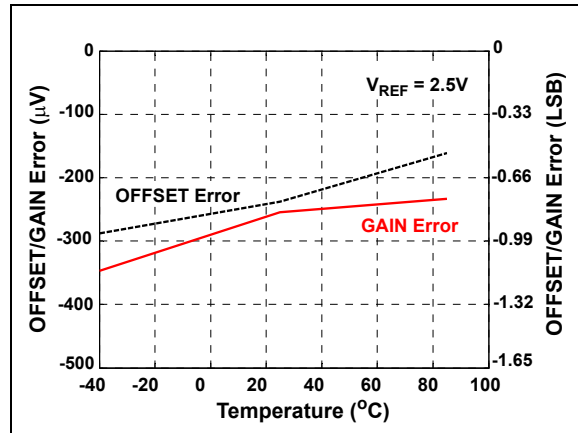

FIGURE 3-33: Offset and Gain Error vs. Temperature: $V_{REF} = 2.5\text{V}$.

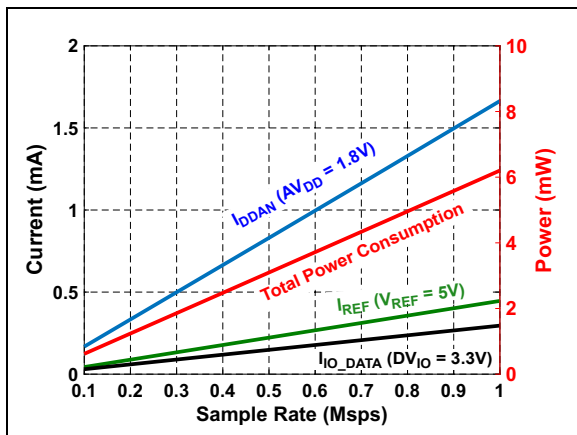

FIGURE 3-32: Power Consumption vs. Sample Rate (Throughput): $C_{LOAD_SDO} = 20\text{ pF}$.

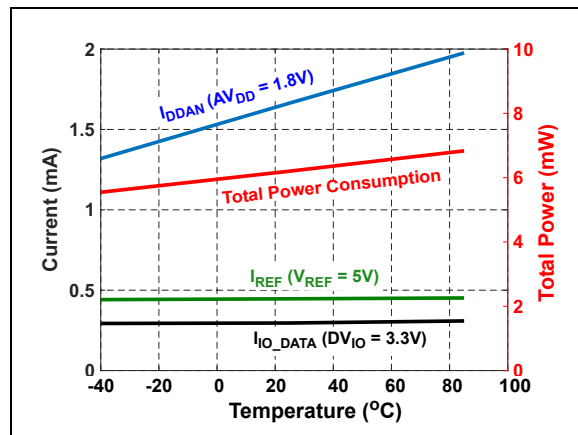

FIGURE 3-34: Power Consumption vs. Temperature: $C_{LOAD_SDO} = 20\text{ pF}$.

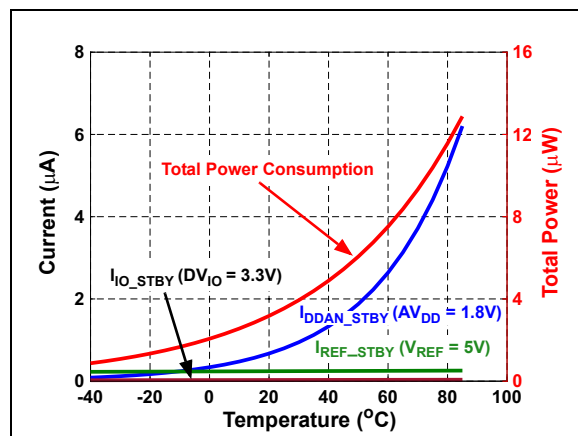

FIGURE 3-35: Power Consumption vs. Temperature during Shutdown.

4.0 TYPICAL PERFORMANCE CURVES FOR MCP33111D-10

Note: The graphs and tables provided following this note are a statistical summary based on a limited number of samples and are provided for informational purposes only. The performance characteristics listed herein are not tested or guaranteed. In some graphs or tables, the data presented may be outside the specified operating range (e.g., outside specified power supply range) and therefore outside the warranted range.

Note: Unless otherwise specified, all parameters apply for $T_A = +25^\circ\text{C}$, $AV_{DD} = 1.8\text{V}$, $DV_{IO} = 3.3\text{V}$, $V_{REF} = 5\text{V}$, $\text{GND} = 0\text{V}$, Differential Analog Input (V_{IN}) = -1 dBFS, $f_{IN} = 10\text{ kHz}$, SPI Clock Input = 60 MHz, Sample Rate (f_S) = 1 Msp. Device = **MCP33111D-10**.

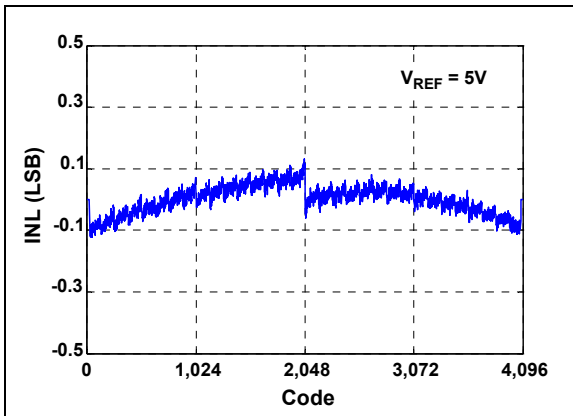

FIGURE 4-1: INL vs. Output Code.

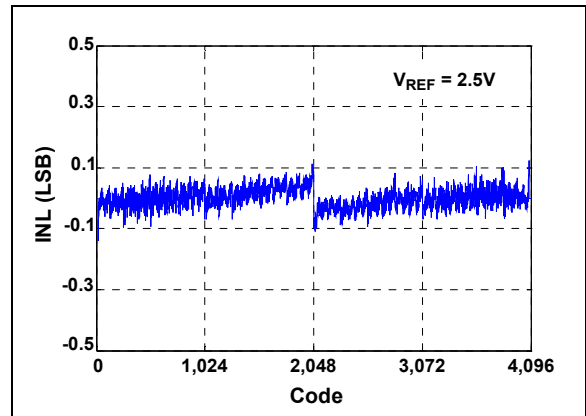

FIGURE 4-4: INL vs. Output Code.

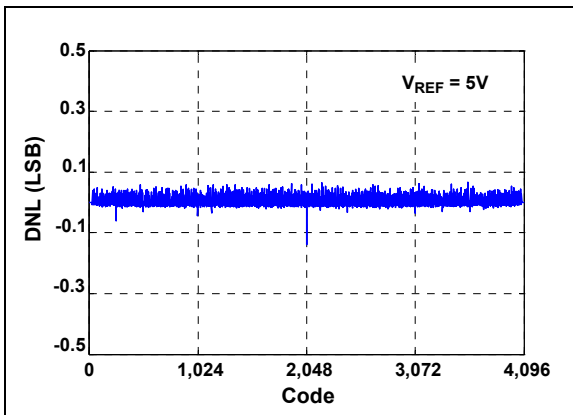

FIGURE 4-2: DNL vs. Output Code.

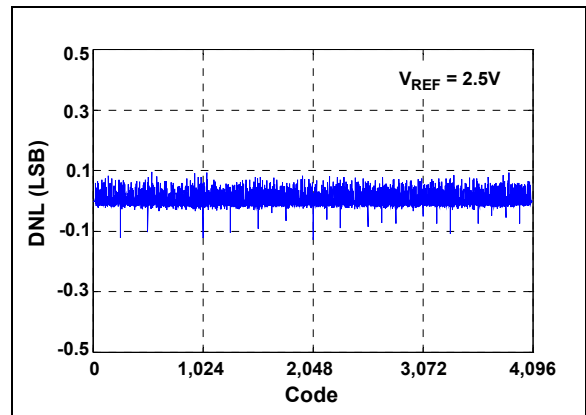

FIGURE 4-5: DNL vs. Output Code.

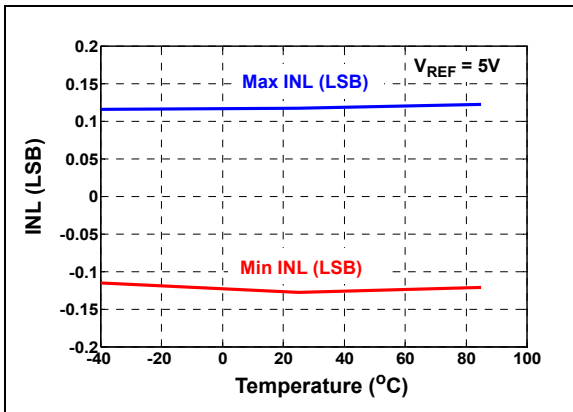

FIGURE 4-3: INL vs. Temperature.

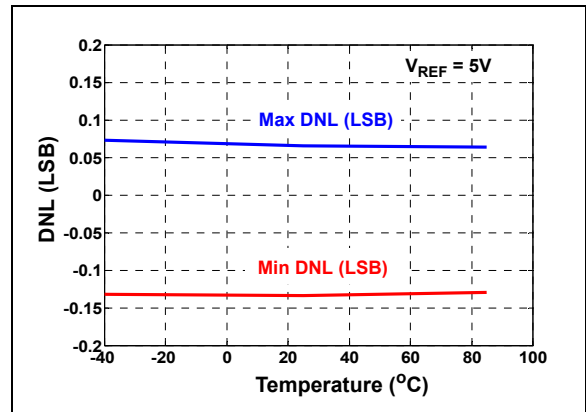

FIGURE 4-6: DNL vs. Temperature.

MCP33131D/21D/11D-10

Note: Unless otherwise specified, all parameters apply for $T_A = +25^\circ\text{C}$, $AV_{DD} = 1.8\text{V}$, $DV_{IO} = 3.3\text{V}$, $V_{REF} = 5\text{V}$, $\text{GND} = 0\text{V}$, Differential Analog Input (V_{IN}) = -1 dBFS, $f_{IN} = 10\text{ kHz}$, SPI Clock Input = 60 MHz, Sample Rate (f_s) = 1 Msps. Device = [MCP33111D-10](#).

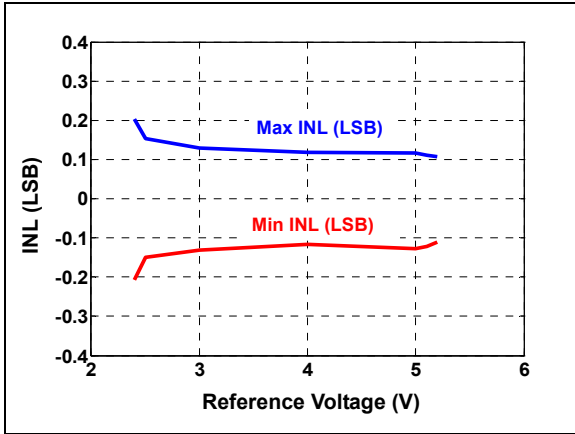

FIGURE 4-7: INL vs. Reference Voltage.

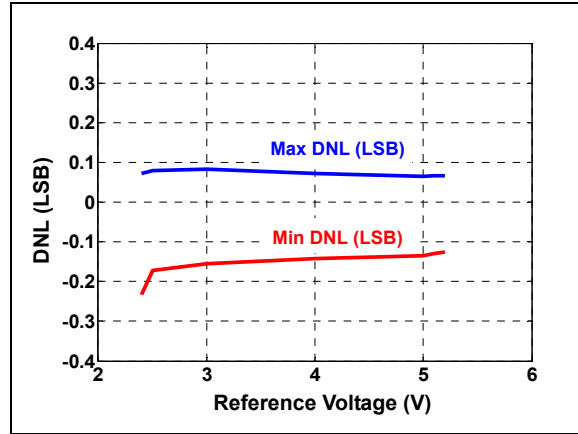

FIGURE 4-10: DNL vs. Reference Voltage.

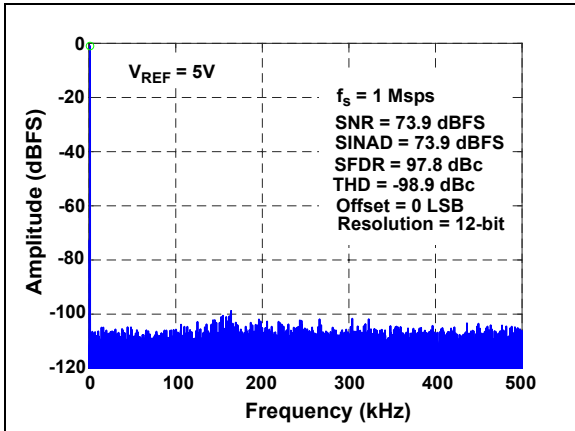

FIGURE 4-8: FFT for 1 kHz Input Signal: $f_s = 1\text{ Msps}$, $V_{IN} = -1\text{ dBFS}$, $V_{REF} = 5\text{V}$.

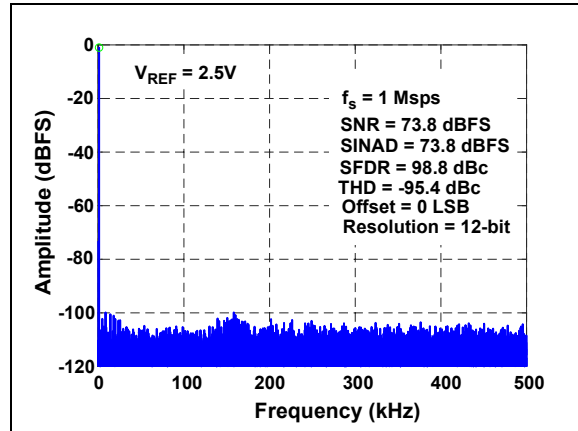

FIGURE 4-11: FFT for 1 kHz Input Signal: $f_s = 1\text{ Msps}$, $V_{IN} = -1\text{ dBFS}$, $V_{REF} = 2.5\text{V}$.

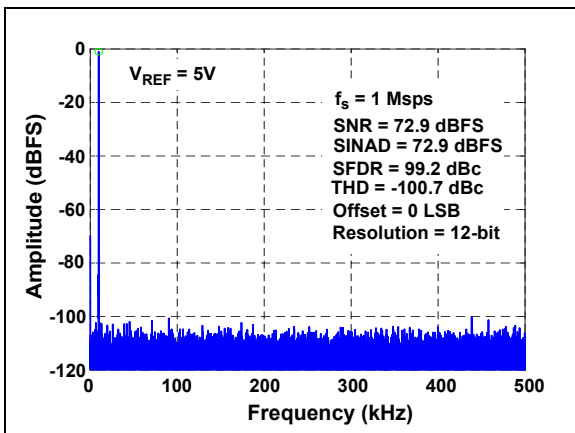

FIGURE 4-9: FFT for 10 kHz Input Signal: $f_s = 1\text{ Msps}$, $V_{IN} = -1\text{ dBFS}$, $V_{REF} = 5\text{V}$.

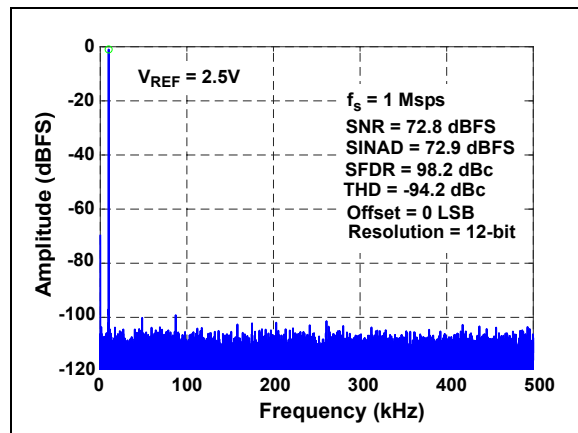

FIGURE 4-12: FFT for 10 kHz Input Signal: $f_s = 1\text{ Msps}$, $V_{IN} = -1\text{ dBFS}$, $V_{REF} = 2.5\text{V}$.

MCP33131D/21D/11D-10

Note: Unless otherwise specified, all parameters apply for $T_A = +25^\circ\text{C}$, $AV_{DD} = 1.8\text{V}$, $DV_{IO} = 3.3\text{V}$, $V_{REF} = 5\text{V}$, $\text{GND} = 0\text{V}$, Differential Analog Input (V_{IN}) = -1 dBFS, $f_{IN} = 10\text{ kHz}$, SPI Clock Input = 60 MHz, Sample Rate (f_S) = 1 Msp. Device = MCP33111D-10.

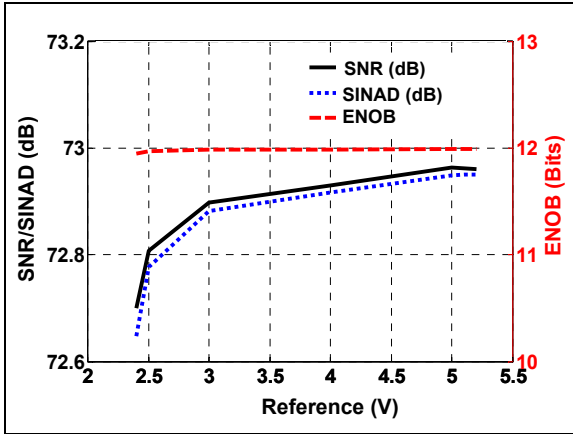

FIGURE 4-13: SNR/SINAD/ENOB vs. V_{REF}

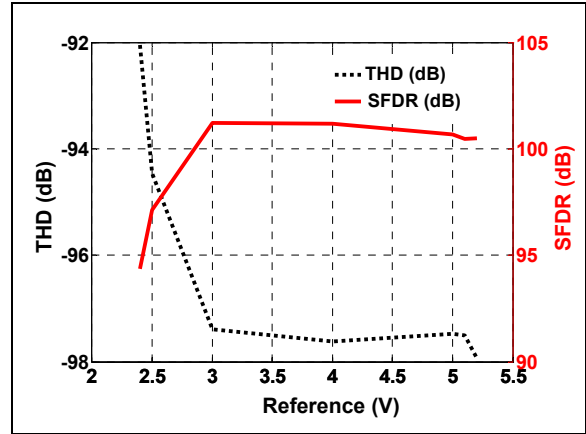

FIGURE 4-16: SFDR/THD vs. V_{REF}

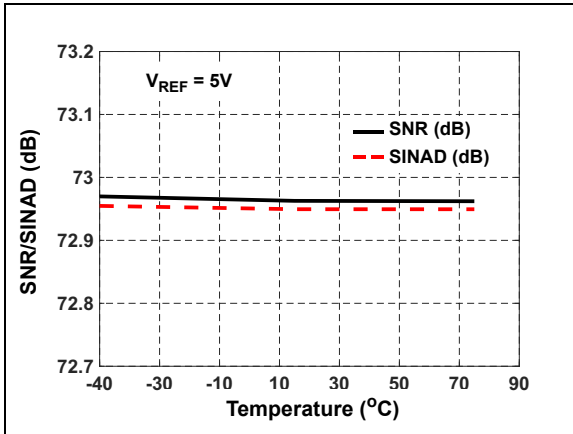

FIGURE 4-14: SNR/SINAD vs. Temperature: $V_{REF} = 5\text{V}$.

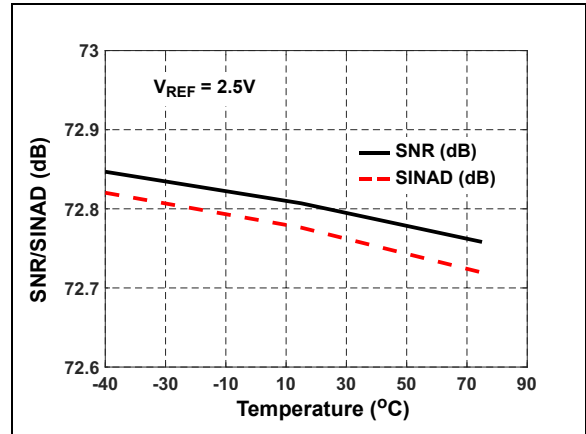

FIGURE 4-17: SNR/SINAD vs. Temperature: $V_{REF} = 2.5\text{V}$.

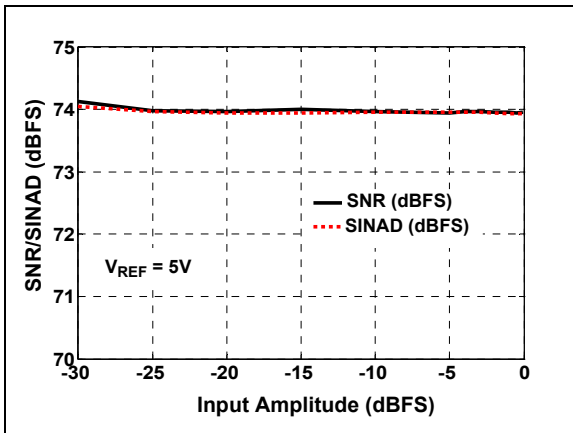

FIGURE 4-15: SNR/SINAD vs. Input Amplitude: $f_{IN} = 10\text{ kHz}$.

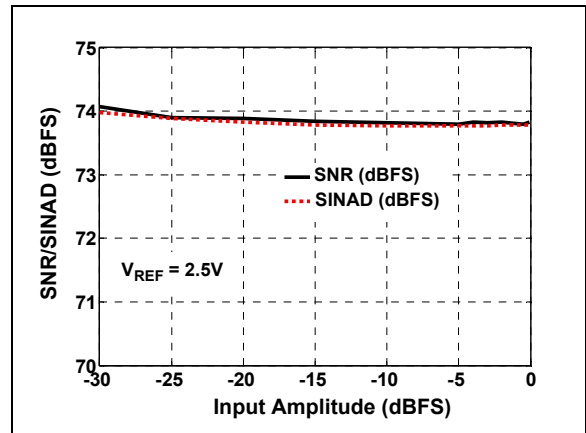

FIGURE 4-18: SNR/SINAD vs. Input Amplitude: $f_{IN} = 10\text{ kHz}$.

MCP33131D/21D/11D-10

Note: Unless otherwise specified, all parameters apply for $T_A = +25^\circ\text{C}$, $AV_{DD} = 1.8\text{V}$, $DV_{IO} = 3.3\text{V}$, $V_{REF} = 5\text{V}$, $\text{GND} = 0\text{V}$, Differential Analog Input (V_{IN}) = -1 dBFS, $f_{IN} = 10\text{ kHz}$, SPI Clock Input = 60 MHz, Sample Rate (f_S) = 1 Msps. Device = [MCP33111D-10](#).

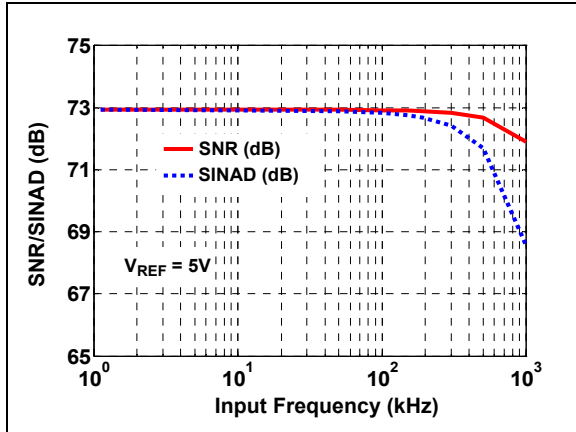

FIGURE 4-19: SNR/SINAD vs. Input Frequency: $V_{IN} = -1\text{ dBFS}$

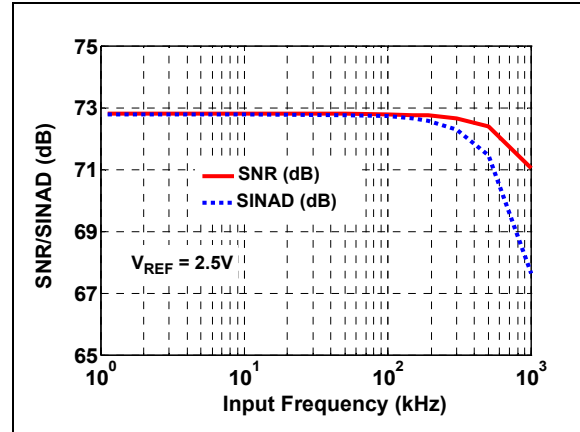

FIGURE 4-22: SNR/SINAD vs. Input Frequency: $V_{IN} = -1\text{ dBFS}$.

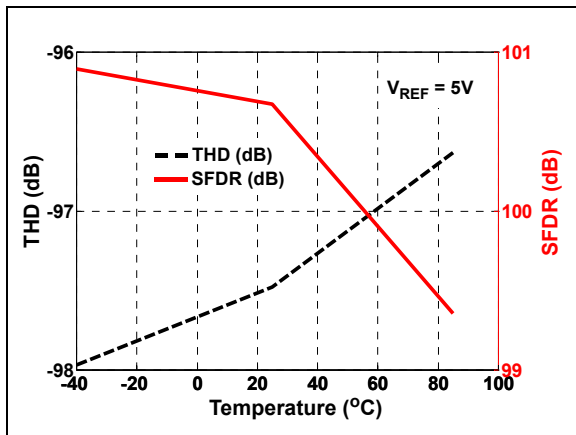

FIGURE 4-20: THD/SFDR vs. Temperature: $V_{REF} = 5\text{V}$.

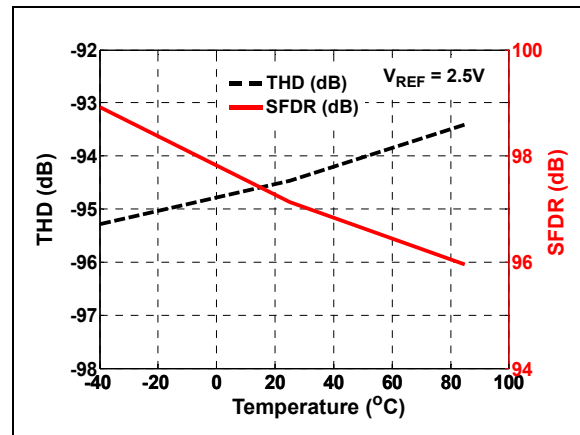

FIGURE 4-23: THD/SFDR vs. Temperature: $V_{REF} = 2.5\text{V}$.

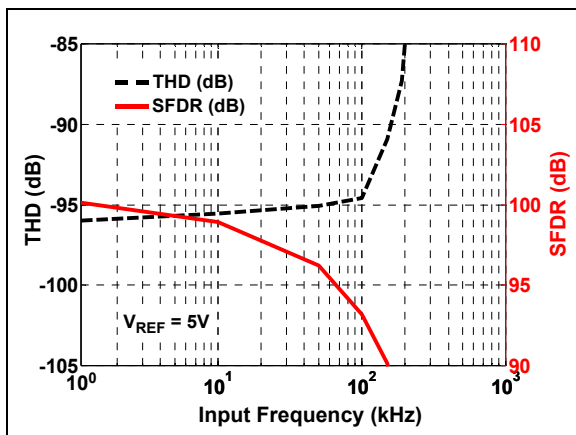

FIGURE 4-21: THD/SFDR vs. Input Frequency: $V_{REF} = 5\text{V}$.

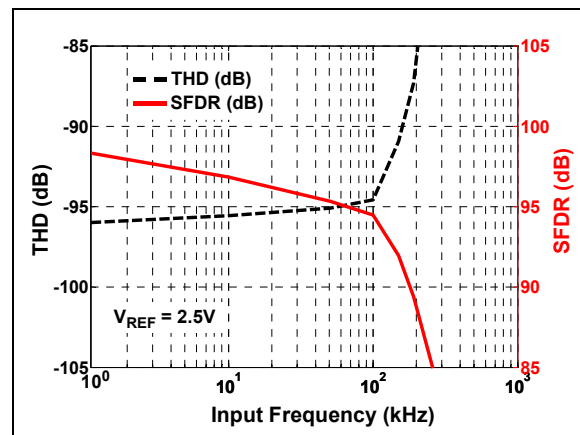

FIGURE 4-24: THD/SFDR vs. Input Frequency: $V_{REF} = 2.5\text{V}$.

MCP33131D/21D/11D-10

Note: Unless otherwise specified, all parameters apply for $T_A = +25^\circ\text{C}$, $V_{DD} = 1.8\text{V}$, $V_{IO} = 3.3\text{V}$, $V_{REF} = 5\text{V}$, $\text{GND} = 0\text{V}$, Differential Analog Input (V_{IN}) = -1 dBFS, $f_{IN} = 10\text{ kHz}$, SPI Clock Input = 60 MHz, Sample Rate (f_S) = 1 Msp. Device = MCP33111D-10.

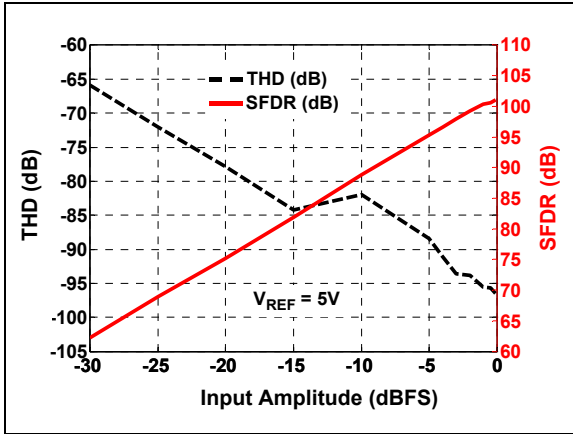

FIGURE 4-25: THD/SFDR vs. Input Amplitude: $V_{REF} = 5\text{V}$.

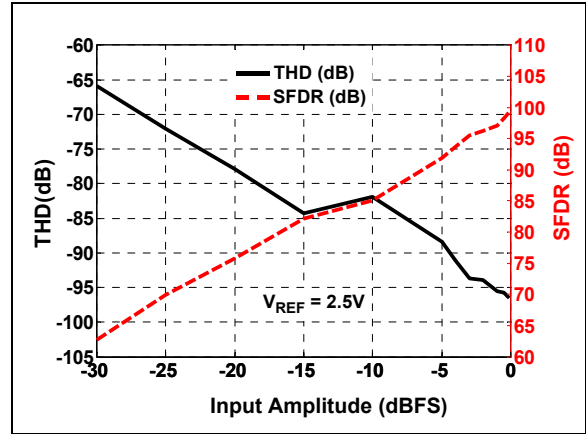

FIGURE 4-28: THD/SFDR vs. Input Amplitude: $V_{REF} = 2.5\text{V}$.

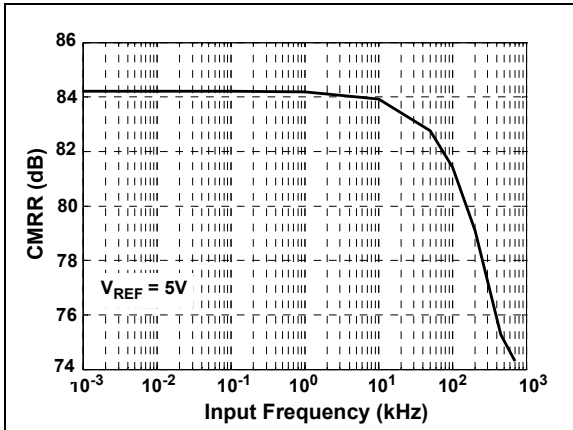

FIGURE 4-26: CMRR vs. Input Frequency: $V_{REF} = 5\text{V}$.

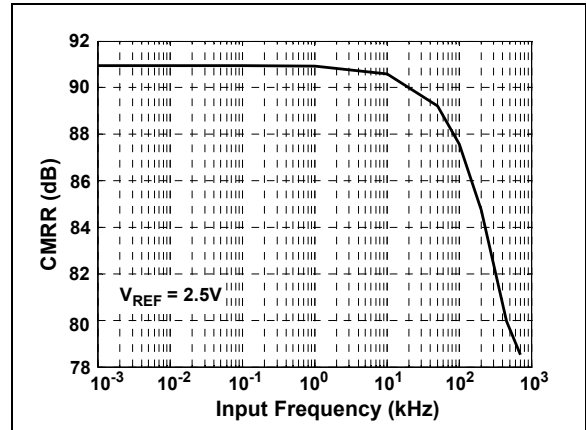

FIGURE 4-29: CMRR vs. Input Frequency: $V_{REF} = 2.5\text{V}$.

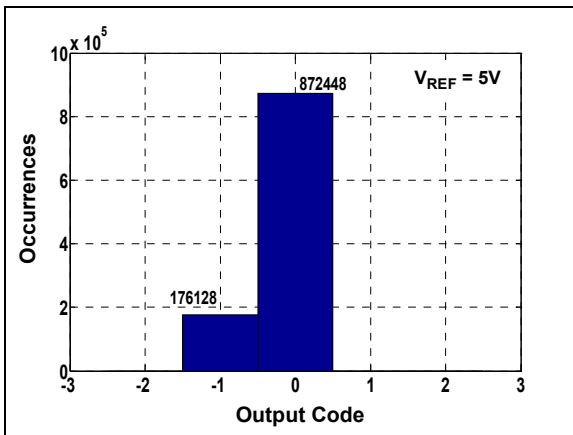

FIGURE 4-27: Shorted Input Histogram: $V_{REF} = 5\text{V}$.

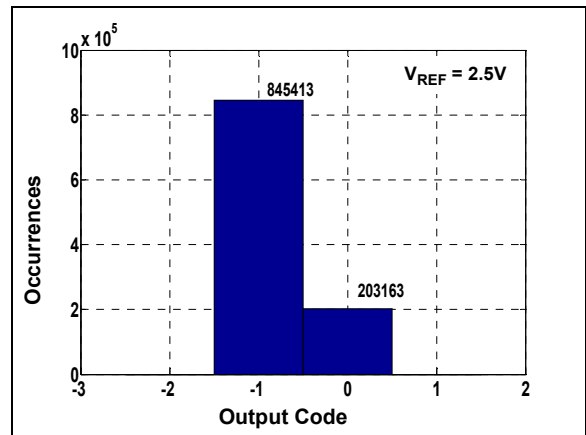

FIGURE 4-30: Shorted Input Histogram: $V_{REF} = 2.5\text{V}$.

MCP33131D/21D/11D-10

Note: Unless otherwise specified, all parameters apply for $T_A = +25^\circ\text{C}$, $AV_{DD} = 1.8\text{V}$, $DV_{IO} = 3.3\text{V}$, $V_{REF} = 5\text{V}$, $\text{GND} = 0\text{V}$, Differential Analog Input (V_{IN}) = -1 dBFS, $f_{IN} = 10\text{ kHz}$, SPI Clock Input = 60 MHz, Sample Rate (f_S) = 1 Msps. Device = [MCP33111D-10](#).

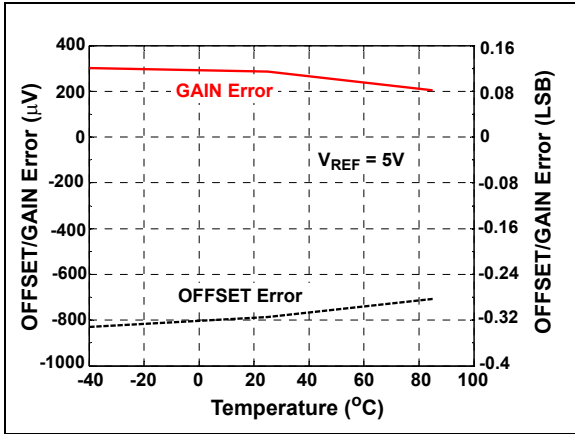

FIGURE 4-31: Offset and Gain Error vs. Temperature: $V_{REF} = 5\text{V}$.

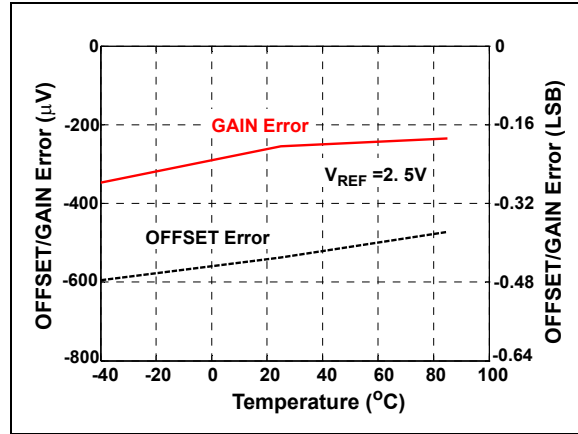

FIGURE 4-33: Offset and Gain Error vs. Temperature: $V_{REF} = 2.5\text{V}$.

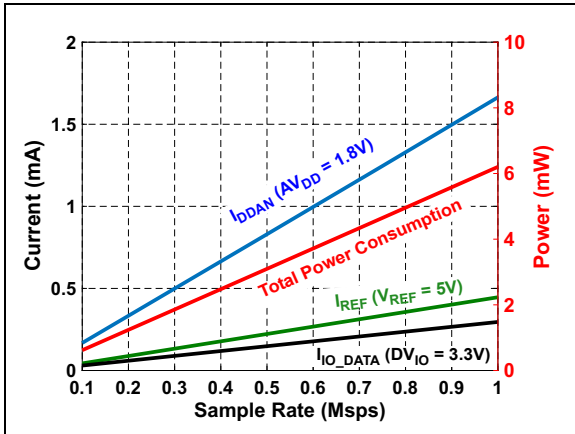

FIGURE 4-32: Power Consumption vs. Sample Rate (Throughput): $C_{LOAD_SDO} = 20\text{ pF}$.

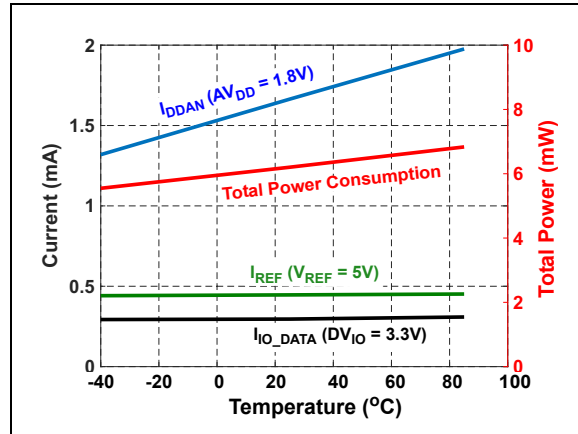

FIGURE 4-34: Power Consumption vs. Temperature: $C_{LOAD_SDO} = 20\text{ pF}$.

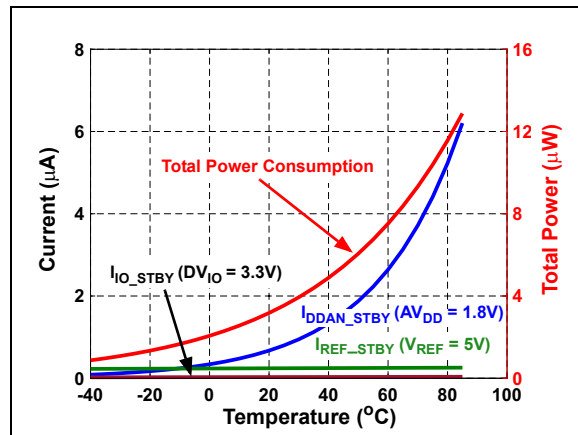

FIGURE 4-35: Power Consumption vs. Temperature during Shutdown.

5.0 PIN FUNCTION DESCRIPTIONS

TABLE 5-1: PIN FUNCTION TABLE

Pin Number	Pin Name	Function
1	V_{REF}	Reference voltage input (2.5V - 5.1V). This pin should be decoupled with a 10 μ F tantalum capacitor.
2	AV_{DD}	DC supply voltage input for analog section (1.8V). This pin should be decoupled with a 1 μ F ceramic capacitor.
3	A_{IN+}	Differential positive analog input.
4	A_{IN-}	Differential negative analog input.
5	GND	Power supply ground reference. This pin is a common ground for both the analog power supply (AV_{DD}) and digital I/O supply (DV_{IO}).
6	CNVST	Conversion-start control and active-low SPI chip-select digital input. A new conversion is started on the rising edge of CNVST. When the conversion is complete, output data is available at SDO by lowering CNVST.
7	SDO	SPI-compatible serial digital data output: ADC conversion data is shifted out by SCLK clock, with MSB first.
8	SCLK	SPI-compatible serial data clock digital input. The ADC output is synchronously shifted out by this clock.
9	SDI	SPI-compatible serial data digital input. Tie to DV_{IO} for normal operation.
10	DV_{IO}	DC supply voltage for digital input/output interface (1.7V - 5.5V). This pin should be decoupled with a 0.1 μ F ceramic capacitor.

5.1 Supply Voltages and Reference Voltage

5.1.1 SUPPLY VOLTAGES (AV_{DD} , DV_{IO})

The device has two power supply pins: (a) 1.8V analog power supply (AV_{DD}), and (b) 1.7V to 5.5V digital input/output interface power supply (DV_{IO}). Since DV_{IO} has a very wide voltage range, some I/O interface signal parameters have slightly different timing specifications depending on the DV_{IO} value. See [Table 1-2](#) for details.

Note: Proper decoupling capacitors (1 μ F to AV_{DD} , 0.1 μ F to DV_{IO}) should be mounted as close as possible to the respective pins.

Note: During the initial power-up sequence, the reference voltage (V_{REF}) must be provided prior to supplying AV_{DD} or within about 64 ms after supplying AV_{DD} . Otherwise, it is strongly recommended to send a recalibrate command. See [Section 7.1 “Recalibrate Command”](#) for more details.

5.1.2 REFERENCE VOLTAGE (V_{REF})

The device requires a single-ended external reference voltage (V_{REF}). The external input reference range is from 2.5V to 5.1V. This reference voltage sets the differential input full-scale range from $-V_{REF}$ to $+V_{REF}$.

The reference pin needs a tantalum decoupling capacitor (10 μ F, 10V rating). Additional multiple ceramic capacitors can be added in parallel to decouple high-frequency noises.

MCP33131D/21D/11D-10

6.0 DEVICE OVERVIEW

The external reference voltage (V_{REF}) ranging from 2.5V to 5.1V sets the differential input full-scale range (FSR) from $-V_{REF}$ to $+V_{REF}$.

The differential input signal needs an appropriate input common-mode voltage from 0V to V_{REF} , depending on the input signal condition. $V_{REF}/2$ is typically used for a symmetric differential input.

When the device is first powered-up, it performs a self-calibration and enters a low current input acquisition mode (Standby) by itself.

During input acquisition (Standby), the internal input sampling capacitors are connected to the input signal, while most of the internal analog circuits are shutdown to save power. During this Standby mode, the device consumes less than 1 μ A.

The user can operate the device with an easy-to-use SPI-compatible 3-wire interface.

The device initiates data conversion on the rising edge of the conversion-start control (CNVST). The device converts the input signals at rates up to 1 Msps with the following timing parameters:

- Sampling the input signal for 290 ns (minimum) and
- Data conversion for 710 ns (maximum).

The input conversion time (710 ns, maximum) is set by the internal clock and the ADC output data is clocked out by the external SPI serial clock (SCLK).

The device provides conversion data with no missing codes. This ADC device family, with a large input full-scale range, high precision, and high throughput (1 Msps) with no output latency, is an ideal choice for various ADC applications.

6.1 Analog Inputs

Figure 6-1 shows a simplified equivalent circuit of the differential input architecture with a switched capacitor input stage. The input sampling capacitors (C_S^+ and C_S^-) are about 31 pF each. The back-to-back diodes ($D_1 - D_2$) at each input are ESD protection diodes. Note that these ESD diodes are tied to V_{REF} , so that each input signal can swing from 0V to $+V_{REF}$ and from $-V_{REF}$ to $+V_{REF}$ differentially.

During input acquisition (Standby), the sampling switches are closed and each input sees the sampling capacitor (≈ 31 pF) in series with on-resistance of the sampling switch, R_{SON} ($\approx 200\Omega$).

For high-precision data conversion applications, the input voltage needs to be fully settled within 1/2 LSB during the input acquisition period (t_{ACQ}). The settling time is directly related to the source impedance: A lower impedance source results in faster input settling

time. Although the MCP33131D/21D/11D-10 can be driven directly with a low impedance source, using a low noise input driver is highly recommended.

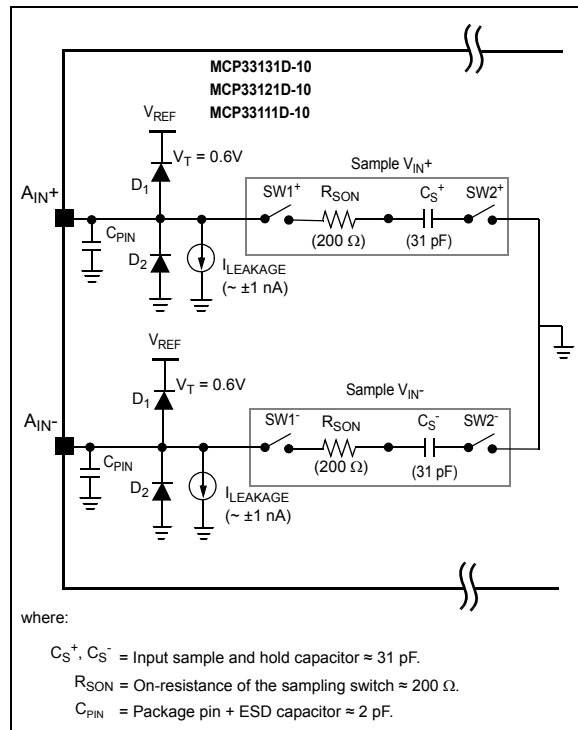

FIGURE 6-1: Simplified Equivalent Analog Input Circuit.

6.1.1 ABSOLUTE MAXIMUM INPUT VOLTAGE RANGE

The input voltage at each input pin (A_{IN}^+ and A_{IN}^-) must meet the following absolute maximum input voltage limits:

- $(V_{IN}^+, V_{IN}^-) < V_{REF} + 0.1V$
- $(V_{IN}^+, V_{IN}^-) > GND - 0.1V$

Note: The ESD diodes at the analog input pins are biased from V_{REF} . Any input voltage outside the absolute maximum range can turn on the input ESD protection diodes and results in input leakage current which may cause conversion errors and permanent damage to the device. Care must be taken in setting the input voltage ranges so that the input voltage does not exceed the absolute maximum input voltage range.

6.1.2 INPUT VOLTAGE RANGE

The differential input (V_{IN}) and common-mode voltage (V_{CM}) at the input pins are defined by:

EQUATION 6-1: DIFFERENTIAL INPUT

$$V_{IN} = V_{IN^+} - V_{IN^-}$$

$$V_{CM} = \frac{V_{IN^+} + V_{IN^-}}{2}$$

where V_{IN^+} is the input at the A_{IN^+} pin and V_{IN^-} is the input at A_{IN^-} pin. The input signal swings around an input common-mode voltage (V_{CM}), typically centered at $V_{REF}/2$ for the best performance.

The absolute value of the differential input (V_{IN}) needs to be less than the reference voltage. The device will output saturated output codes (all 0s or all 1s except sign bit) if the absolute value of the input (V_{IN}) is greater than the reference voltage.

The differential input full-scale voltage range (FSR) is given by the external reference voltage (V_{REF}) setting:

EQUATION 6-2: FSR AND INPUT RANGE

$$\text{Input Full-Scale Range (FSR)} = 2V_{REF}$$

$$\text{Input Range: } -V_{REF} \leq V_{IN} \leq (V_{REF} - 1LSB)$$

6.2 Analog Input Conditioning Circuits

The device supports various input types, such as: (a) fully-differential inputs, (b) arbitrary waveform inputs and (c) single-ended inputs.

6.2.1 FULLY-DIFFERENTIAL INPUT SIGNALS

The MCP33131D/21D/11D-10 device provides the best linearity performance with fully-differential inputs. [Figure 6-2](#) shows an example of a fully-differential input conditioning circuit with a differential input driver followed by an RC anti-aliasing filter. [Figure 6-3](#) shows its transfer function.

The differential input (V_{IN}) between the two differential ADC analog input pins (A_{IN^+} , A_{IN^-}) swings from $-V_{REF}$ to $+V_{REF}$ centered at the input common-mode voltage (V_{OCM}).

The front-end differential driver provides a low output impedance, which provides fast settling of the analog inputs during the acquisition phase and provides isolation between the signal source and the ADC. The RC low-pass anti-aliasing filter band-limits the output noise of the input driver and attenuates the kick-back noise spikes from the ADC during conversion.

[Figure 6-2](#) is the reference circuit that is used to collect most of the linearity performance data shown in [Table 1-1](#).

The differential input driver shown in [Figure 6-2](#) can be replaced with a low noise dual-channel op-amp. See [Section 6.3.1 "Input Driver Selection"](#) for the driver selection.

Note: Contact Microchip Technology Inc. for availability of the differential input driver and alternative low-noise op-amp selection for the high-precision ADC applications.

6.2.2 ARBITRARY WAVEFORM INPUT SIGNALS

The MCP33131D/21D/11D-10 device can convert input signals with arbitrary waveforms, such as the inputs at A_{IN^+} and A_{IN^-} are symmetric, non-symmetric or independent with respect to each other.

In the arbitrary input configuration, each ADC analog input is connected to a single ended source ranging from 0V to V_{REF} . In this case, the ADC converts the voltage difference between the two input signals. [Figure 6-4](#) shows the configuration example for the arbitrary input signals.

6.2.3 SINGLE-ENDED INPUT SIGNALS

The MCP33131D/21D/11D-10 device can convert single-ended input signals. The most commonly recommended single-ended configurations are: (a) pseudo-differential bipolar configuration and (b) pseudo-differential unipolar configuration.

6.2.3.1 Pseudo-Differential Bipolar Configuration

In the pseudo-differential bipolar configuration, one of the ADC analog inputs (typically A_{IN^-}) is driven with a fixed DC voltage (typically $V_{REF}/2$), while the other (A_{IN^+}) is connected to a single-ended signal in the range 0V to V_{REF} .

In this case, the ADC converts the voltage difference between the single-ended signal and the DC voltage. [Figure 6-5](#) shows the configuration example and [Figure 6-6](#) shows its transfer function.

6.2.3.2 Pseudo-Differential Unipolar Configuration

In the pseudo-differential unipolar input configuration, one of the ADC analog inputs (typically A_{IN^-}) is connected to ground, while the other (A_{IN^+}) is connected to a single ended signal in the range 0V to V_{REF} .

In this case, the ADC converts the voltage difference between the single ended signal and ground. [Figure 6-7](#) shows the configuration example and [Figure 6-8](#) shows its transfer function.

MCP33131D/21D/11D-10

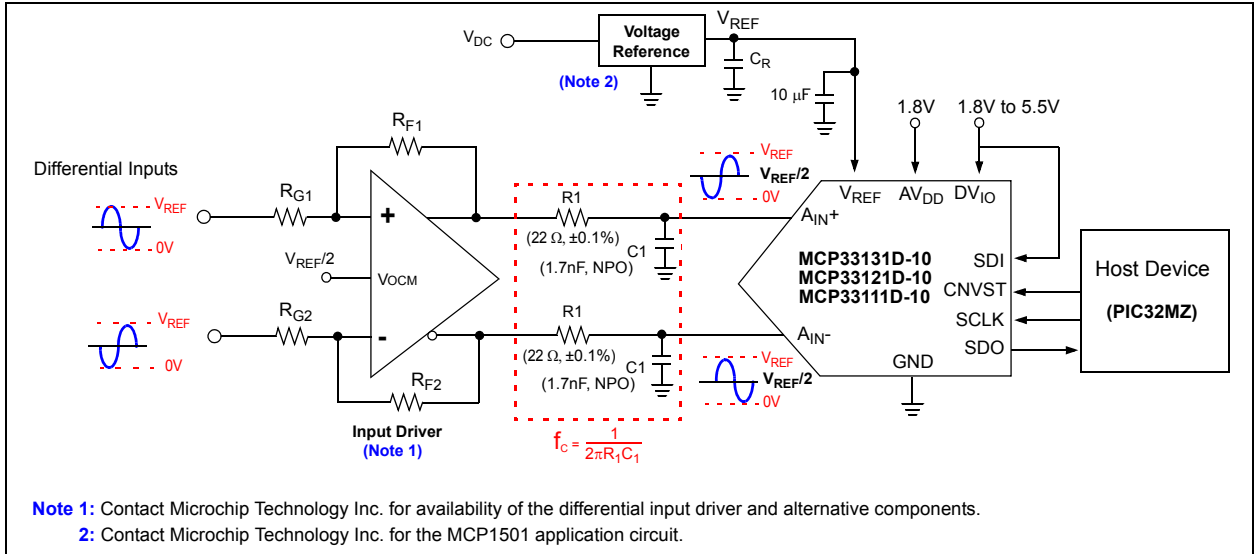

FIGURE 6-2: Input Conditional Circuit for Fully-Differential Input.

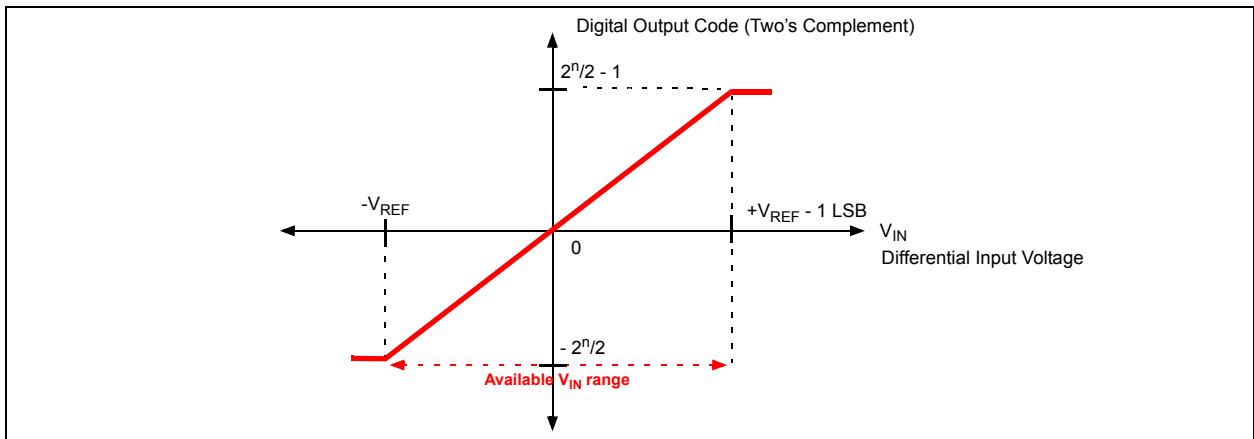

FIGURE 6-3: Transfer Function for Figure 6-2.

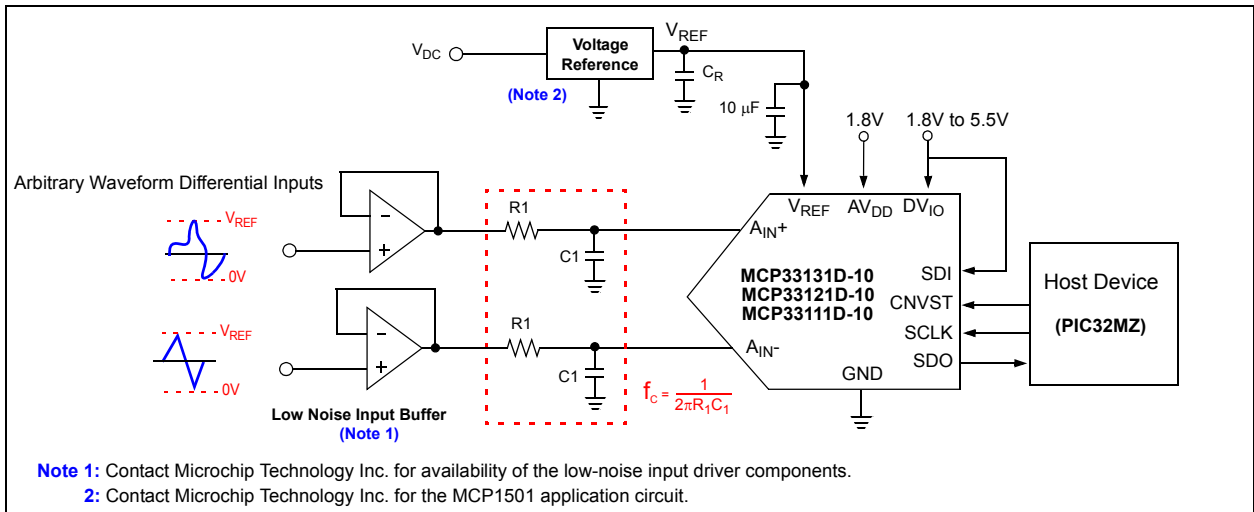

FIGURE 6-4: Input Configuration for Arbitrary Waveform Input Signals.

MCP33131D/21D/11D-10

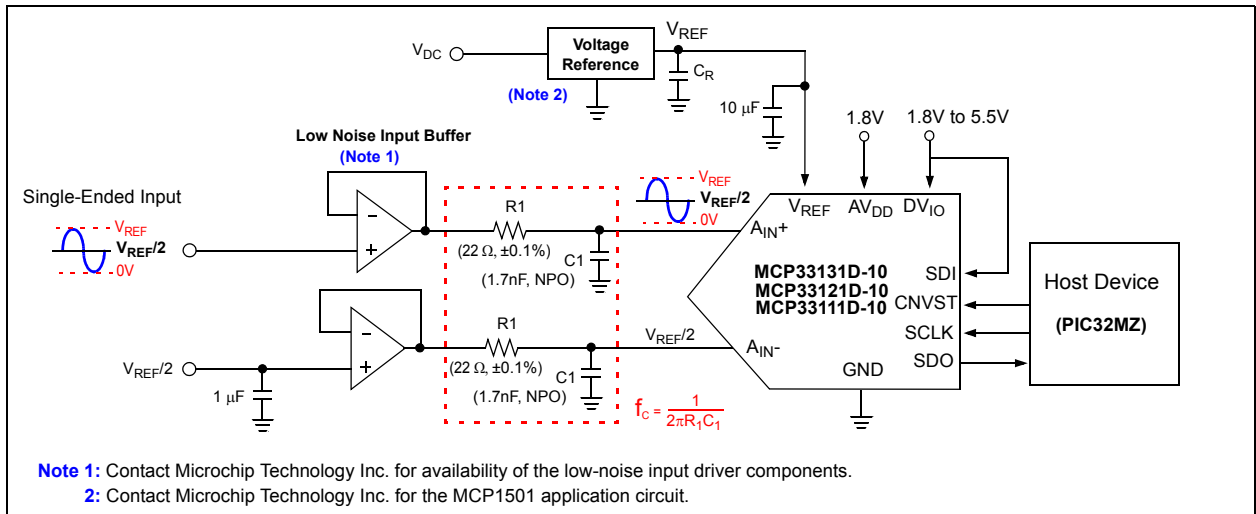
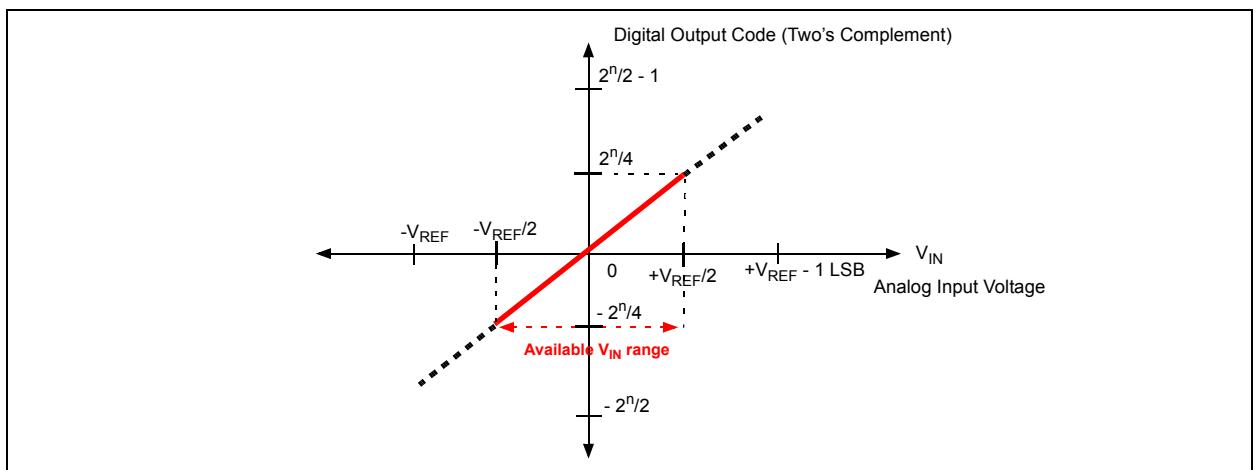

FIGURE 6-5: Pseudo-Differential Bipolar-Input Configuration for Single-Ended Input Signal.



MCP33131D/21D/11D-10

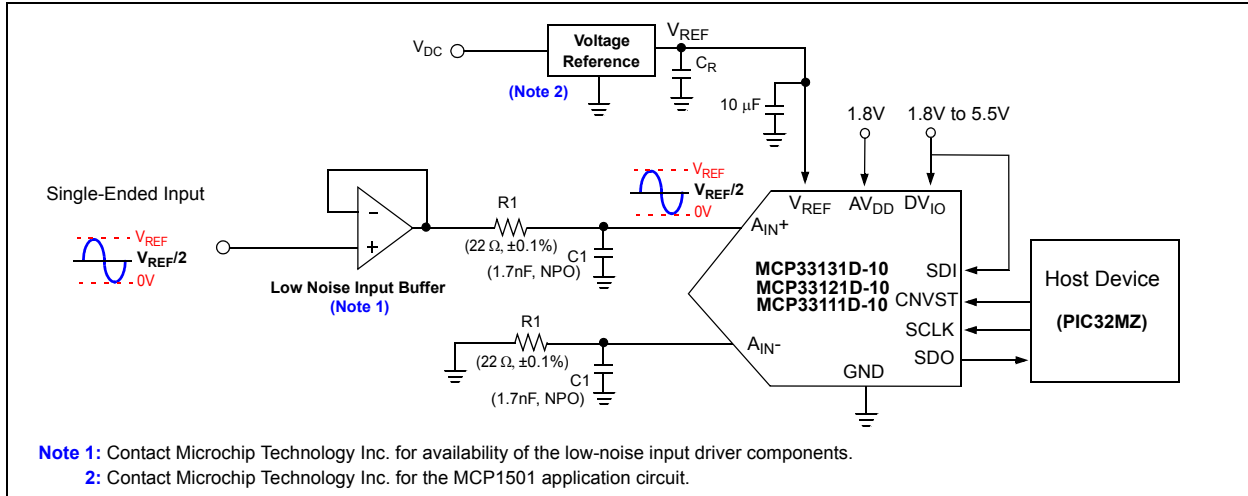

FIGURE 6-7: Pseudo-Differential Unipolar-Input Configuration for Single-Ended Input Signal.

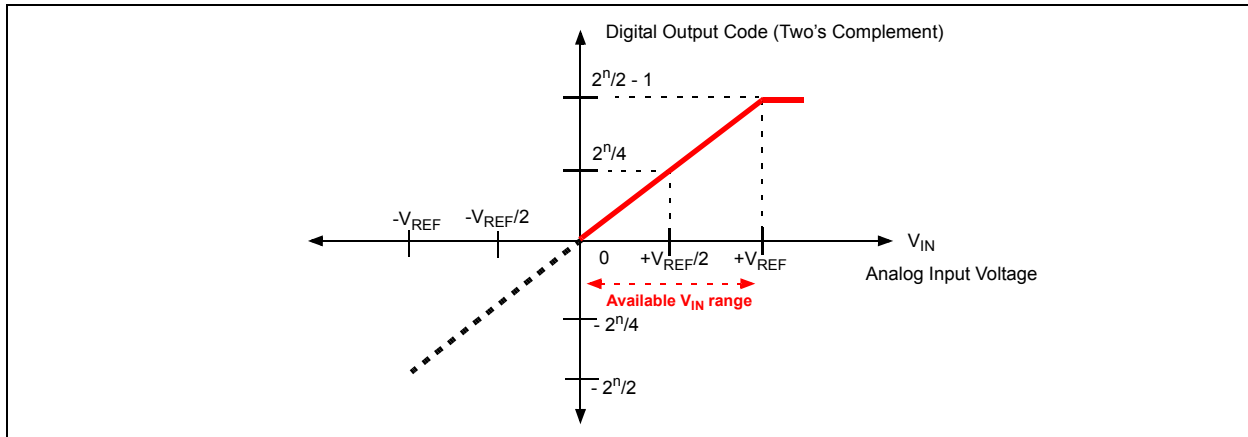

FIGURE 6-8: Transfer Function for Figure 6-7.

Figure 6-9 shows a simplified system noise presentation for the front-end driver and ADC.

6.3 Voltage Reference Selection

The performance of the voltage reference has a large impact on the accuracy of high-precision data acquisition systems. The voltage reference should have high-accuracy, low-noise, and low-temperature drift. A $\pm 0.1\%$ output accuracy of the reference directly corresponds to $\pm 0.1\%$ absolute accuracy of the ADC output. The RMS output noise voltage of the reference should be less than $1/2$ LSB of the ADC.

6.3.1 INPUT DRIVER SELECTION

The noise and distortion of the ADC input driver can degrade the dynamic performance (SNR, SFDR, and THD) of the overall ADC application system. Therefore, the input driver with better specifications than those of the ADC itself needs to be selected. The data sheet of the driver typically shows the output noise voltage and harmonic distortion parameters.

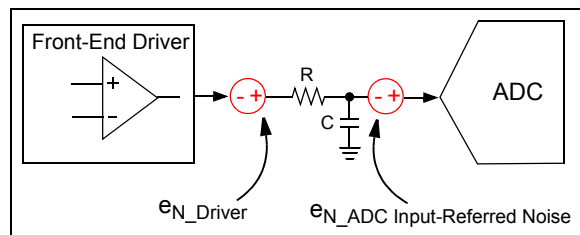

FIGURE 6-9: Simplified System Noise Representation.

- **Unity-Gain Bandwidth:** An input driver with higher bandwidth typically results in better overall linearity performance. Typically, the driver should have the unity-gain bandwidth greater than 5 times the -3 dB cutoff frequency of the anti-aliasing filter:

EQUATION 6-3: BANDWIDTH REQUIREMENT FOR ADC INPUT DRIVER

$$BW_{Input\ Driver} \geq 5 \times f_{B_RC}$$

$$\geq \frac{5}{2\pi RC}$$

where, f_{B_RC} = -3 dB bandwidth of RC anti-aliasing filter as shown in [Figure 6-9](#).

- **Distortion:** The nonlinearity of the input driver causes distortions in the ADC output. Therefore, the input driver should have less distortion than the ADC itself. The recommended total harmonic distortion (THD) of the driver is at least 10 dB less than that of the ADC:

EQUATION 6-4: RECOMMENDED THD FOR ADC INPUT DRIVER

$$THD_{Input\ Buffer} \leq THD_{ADC} -10$$

- **ADC Input-Referred Noise:** When the ADC is operating with a full-scale input range, the ADC input-referred RMS noise is approximated as shown in [Equation 6-5](#).

EQUATION 6-5: ADC INPUT-REFERRED NOISE

$$e_{N_RMS_ADC_Input-Referred\ Noise} = \frac{FSR}{2\sqrt{2}} 10^{\frac{SNR}{20}}$$

$$= \frac{V_{REF}}{\sqrt{2}} 10^{\frac{SNR}{20}}$$

where FSR is the input full-scale input range of ADC.

- **Noise Contribution from the Front-End Driver:**

The noise from the input driver can degrade the ADC's SNR performance. Therefore, an input driver should have very low broadband noise density and very low 1/f noise, as possible. When an anti-aliasing filter is used, the output noise density is integrated over the -3 dB bandwidth of the filter. This noise voltage from the ADC input driver should be kept much less than the input-referred noise of the ADC.

[Equation 6-6](#) shows the RMS output noise calculation for the front-end input driver.

EQUATION 6-6: NOISE FROM FRONT-END DRIVER

$$e_{N_RMS_Driver} = \sqrt{(e_{N_BroadBand})^2 + (e_{N_Flicker})^2} \approx G_N \sqrt{e_N^2 \frac{\pi}{2} f_B}$$

where 1/f noise term is very small compared to the broadband noise, and ignored.

(a) Single-ended unity-gain buffer driver for single-ended input:

$$e_{N_RMS_Driver_Single\ Ended\ Buff} \approx \frac{e_N}{\sqrt{2}} \sqrt{\pi f_B}$$

(b) Differential unity-gain buffer driver (or using two single-ended buffers) for differential input:

$$e_{N_RMS_Driver_Differential\ Buffer} = G_N \sqrt{2} \sqrt{e_N^2 \frac{\pi}{2} f_B}$$

$$\approx e_N \sqrt{\pi f_B} \quad , \text{ for the input driver without feedback resistors } (G_N = 1)$$

$$\approx 2e_N \sqrt{\pi f_B} \quad , \text{ for the input driver with feedback resistors } (G_N = 2)$$

G_N in [Equation 6-6](#) is the noise gain and becomes 1 for a unity gain buffer driver without a feedback resistor and 2 if a feedback resistor is used. $e_{N_Flicker}$ is typically represented by 1/f noise. If 1/f noise is not-negligible, and specified in the driver's data sheet, the user may include $e_{Npp(1/f)}/6.6$ for the $e_{N_Flicker}$ term in the equation.

MCP33131D/21D/11D-10

For 16-bit high precision ADC applications, the noise contribution from the front-end input buffer is typically constrained to be less than about 20% ($\alpha = 0.2$) of the ADC input-referred noise.

By applying this 20% rule ($\alpha = 0.2$) and using [Equation 6-5](#) and [Equation 6-6](#), the recommended noise voltage density (e_N) limit of the ADC input driver is expressed in [Equation 6-7](#):

EQUATION 6-7: NOISE DENSITY FOR ADC INPUT DRIVER

Noise from ADC input driver $\leq \sim 20\%$ (α) of ADC input-referred noise

(a) Differential unity-gain buffer driver (or with two single-ended unity-gain buffers):

$$e_N \leq \frac{0.2}{\sqrt{2\pi} f_{B_RC}} V_{REF} 10^{\frac{-SNR}{20}} \left(\frac{V}{\sqrt{Hz}} \right)$$

(b) Single-ended unity-gain buffer driver for a single-ended input:

$$e_N \leq \frac{0.2}{\sqrt{\pi} f_{B_RC}} V_{REF} 10^{\frac{-SNR}{20}} \left(\frac{V}{\sqrt{Hz}} \right)$$

Using [Equation 6-7](#), the recommended maximum noise voltage density limit for the ADC input driver can be estimated. [Table 6-1](#) to [Table 6-3](#) show the recommended maximum limits with $\alpha = 20\%$.

TABLE 6-1: Noise Voltage Density for Input Driver (Recommended), for MCP33131D-10 with SNR = 93 dB

V_{REF}	ADC Input-Referred Noise (Note 3)	f_{B_RC} (Note 2)	Noise Voltage Density (e_N) (Maximum Value) (Note 1)
2.5V	39.6 μ V	3 MHz	2.6 nV/ \sqrt{Hz}
		4 MHz	2.2 nV/ \sqrt{Hz}
		5 MHz	2.0 nV/ \sqrt{Hz}
3.3V	52.2 μ V	3 MHz	3.4 nV/ \sqrt{Hz}
		4 MHz	2.9 nV/ \sqrt{Hz}
		5 MHz	2.6 nV/ \sqrt{Hz}
5V	79.2 μ V	3 MHz	5.2 nV/ \sqrt{Hz}
		4 MHz	4.5 nV/ \sqrt{Hz}
		5 MHz	4.0 nV/ \sqrt{Hz}

Note 1: $\alpha = 20\%$ is applied.
 2: f_{B_RC} is -3dB bandwidth of the anti-aliasing filter.
 3: See [Equation 6-5](#) for the ADC input referred noise calculation.

TABLE 6-2: Noise Voltage Density of Input Driver (Recommended), for MCP33121D-10 with SNR = 85 dB

V_{REF}	ADC Input-Referred Noise (Note 3)	f_{B_RC} (Note 2)	Noise Voltage Density (e_N) (Maximum Value) (Note 1)
2.5V	99.4 μ V	3 MHz	6.5 nV/ \sqrt{Hz}
		4 MHz	5.6 nV/ \sqrt{Hz}
		5 MHz	5.0 nV/ \sqrt{Hz}
3.3V	131.2 μ V	3 MHz	8.6 nV/ \sqrt{Hz}
		4 MHz	7.4 nV/ \sqrt{Hz}
		5 MHz	6.6 nV/ \sqrt{Hz}
5V	198.8 μ V	3 MHz	13 nV/ \sqrt{Hz}
		4 MHz	11.2 nV/ \sqrt{Hz}
		5 MHz	10.0 nV/ \sqrt{Hz}

Note 1: $\alpha = 20\%$ is applied.
 2: f_{B_RC} is -3dB bandwidth of the anti-aliasing filter.
 3: See [Equation 6-5](#) for the ADC input referred noise calculation.

TABLE 6-3: Noise Voltage Density of Input Driver (Recommended), for MCP33111D-10 with SNR = 74 dB

V_{REF}	ADC Input-Referred Noise (Note 3)	f_{B_RC} (Note 2)	Noise Voltage Density (e_N) (Maximum Value) (Note 1)
2.5V	352.7 μ V	3 MHz	23 nV/ \sqrt{Hz}
		4 MHz	20 nV/ \sqrt{Hz}
		5 MHz	18 nV/ \sqrt{Hz}
3.3V	465.6 μ V	3 MHz	30 nV/ \sqrt{Hz}
		4 MHz	26 nV/ \sqrt{Hz}
		5 MHz	24 nV/ \sqrt{Hz}
5V	705.4 μ V	3 MHz	46 nV/ \sqrt{Hz}
		4 MHz	40 nV/ \sqrt{Hz}
		5 MHz	36 nV/ \sqrt{Hz}

Note 1: $\alpha = 20\%$ is applied.
 2: f_{B_RC} is -3dB bandwidth of the anti-aliasing filter.
 3: See [Equation 6-5](#) for ADC input referred noise calculation.

6.4 Device Operation

When the device is first powered-up, it self-calibrates internal systems and enters input acquisition mode by itself. The device operates in two phases: (a) Input Acquisition (Standby) and (b) Data Conversion. Figure 6-10 shows the ADC operating sequence.

6.4.1 INPUT ACQUISITION PHASE (STANDBY)

During the input acquisition phase (t_{ACQ}), also called Standby, the two input sampling capacitors, C_S^+ and C_S^- , are connected to the A_{IN}^+ and A_{IN}^- pins, respectively. The input voltage is sampled until a rising edge on CNVST is detected. The input voltage should be fully settled within 1/2 LSB during t_{ACQ} .

During this input acquisition time (t_{ACQ}), the ADC consumes less than 1 μA . The system designer can increase the acquisition time (t_{ACQ}) as long as needed for additional power savings.

6.4.2 DATA CONVERSION PHASE

The start of the conversion is controlled by CNVST. On the rising edge of CNVST, the sampled charge is locked (sample switches are opened) and the ADC performs the conversion. Once a conversion is started, it will not stop until the current conversion is complete.

The data conversion takes a maximum of 710 ns. After the conversion is complete and the host lowers CNVST, the output data is presented on SDO.

The output data is clocked out MSB first. While the output data is being transferred, the device enters the next input acquisition phase.

Note: Transferring output data during the acquisition phase can disturb the next input sample. It is highly recommended to allow at least t_{QUIET} (10 ns, typical) between the last edge on the SPI interface and the rising edge on CNVST. See Figure 1-1 for t_{QUIET} .

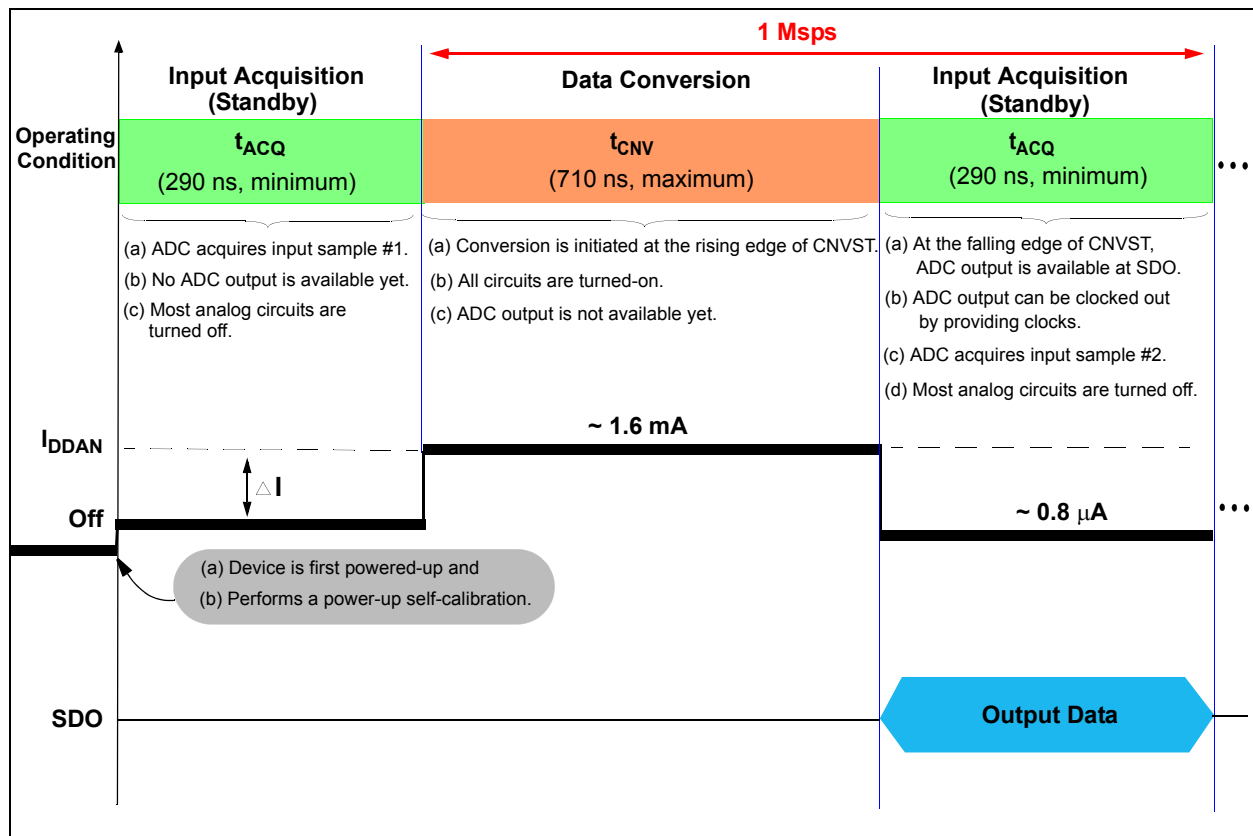

FIGURE 6-10: Device Operating Sequence.

MCP33131D/21D/11D-10

6.4.3 SAMPLE (THROUGHPUT) RATE

The device completes data conversion within 710 ns (t_{CNV}). The continuous input sample rate is the inverse of the sum of input acquisition time (t_{ACQ}) and data conversion time (t_{CNV}). The following equation shows the continuous sample rate calculation. If the user sets the acquisition time (t_{ACQ}) to be 290 ns, the sample rate becomes 1 Msps.

EQUATION 6-8: SAMPLE RATE

$$\text{Sample Rate} = \frac{1}{(t_{ACQ} + t_{CNV})} = \frac{1}{(290ns + 710ns)} = 1 \text{ Msps}$$

6.4.4 SERIAL SPI CLOCK FREQUENCY REQUIREMENT

For a continuous data collection sequence, the SPI clock frequency should be fast enough to clock out all data during the input acquisition time (t_{ACQ}). The minimum SPI clock frequency requirement is determined by the following equation:

EQUATION 6-9: SPI CLOCK FREQUENCY REQUIREMENT

$$t_{ACQ} = N \times T_{SCLK} + t_{QUIET} + t_{EN}$$

$$f_{SCLK} = \frac{1}{T_{SCLK}} = \frac{N}{t_{ACQ} - (t_{QUIET} + t_{EN})}$$

where N is the number of output data bits, given by
 N = 16-bit for MCP33131D-10
 = 14-bit for MCP33121D-10
 = 12-bit for MCP33111D-10

where f_{SCLK} is the minimum SPI serial clock speed required to transfer all N-bits of output data during the input acquisition time (t_{ACQ}).

Table 6-4 shows the minimum SPI clock frequency (f_{SCLK}) requirements of each device for various input acquisition times. In the table, t_{ACQ} includes $t_{EN} = 10$ ns and $t_{QUIET} = 10$ ns for $DV_{IO} = 3.3V$, and $t_{CNV} = 710$ ns is used for the continuous sampling rate (f_s) calculation.

TABLE 6-4: SPI CLOCK FREQUENCY REQUIREMENT VS. ACQUISITION TIME (T_{ACQ})

t_{ACQ} (nS)	SPI Clock (f_{SCLK}) Speed Requirement			f_s (Msps)
	MCP33131D-10 (16-bit)	MCP33121D-10 (14-bit)	MCP33111D-10 (12-bit)	
290	59.26 MHz	51.85 MHz	44.44 MHz	1
300	53.33 MHz	46.67 MHz	40 MHz	0.99
320	50 MHz	43.75 MHz	37.5 MHz	0.97
400	40 MHz	35 MHz	30 MHz	0.9
500	32 MHz	28 MHz	24 MHz	0.83
1290	12.4 MHz	10.85 MHz	9.3 MHz	0.5

6.5 Transfer Function

The differential analog input is

$$V_{IN} = (V_{IN+}) - (V_{IN-})$$

The LSB size is given by Equation 6-10, and an example of LSB size vs. reference voltage is summarized in Table 6-5.

EQUATION 6-10: LSB SIZE - EXAMPLE

$$LSB = \frac{2 V_{REF}}{2^N}$$

where N is the resolution of the ADC in bits.

TABLE 6-5: LSB SIZE VS. REFERENCE

Reference Voltage (V_{REF})	LSB Size		
	MCP33131D-10 (16-bit)	MCP33121D-10 (14-bit)	MCP33111D-10 (12-bit)
2.5V	76.3 μ V	305.2 μ V	1.2207 mV
2.7V	82.4 μ V	329.6 μ V	1.3184 mV
3V	91.6 μ V	366.2 μ V	1.4648 mV
3.3V	100.7 μ V	402.8 μ V	1.6113 mV
3.5V	106.8 μ V	427.3 μ V	1.7090 mV
4V	122.1 μ V	488.3 μ V	1.9531 mV
4.5V	137.3 μ V	549.3 μ V	2.1973 mV
5V	152.6 μ V	610.4 μ V	2.4414 mV
5.1	155.6 μ V	622.6 μ V	2.4902 mV

Figure 6-11 shows the ideal transfer function and Table 6-6 shows the digital output codes for the MCP33131D/21D/11D-10.

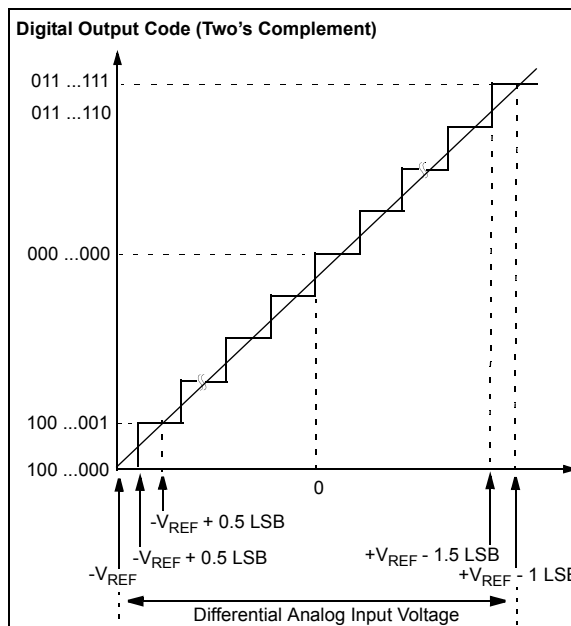

FIGURE 6-11: Ideal Transfer Function for Fully-Differential Input Signal.

6.6 Digital Output Code

The digital output code is proportional to the input voltage. The output data is in binary two's complement format. With this coding scheme the MSB can be considered a sign indicator. When the MSB is a logic '0', the input is positive. When the MSB is a logic '1', the input is negative. The following is an example of the output code:

(a) for a negative full-scale input voltage: 100...000

$$\text{Example: } (V_{IN+}) - (V_{IN-}) = -V_{REF}$$

(b) for a zero differential input voltage: 000...000

$$\text{Example: } (V_{IN+}) - (V_{IN-}) = 0$$

(c) for a positive full-scale input voltage: 011...111

$$\text{Example: } (V_{IN+}) - (V_{IN-}) = +V_{REF}$$

The MSB (sign bit) is always transmitted first through the SDO pin.

The code will be locked at 0111...11 for all voltages greater than $(V_{REF} - 1 \text{ LSB})$ and 1000...00 for voltages less than $-V_{REF}$. Table 6-6 shows an example of output codes of various input levels.

TABLE 6-6: DIGITAL OUTPUT CODE

Input Voltage (V)	Digital Output Codes		
	MCP33131D-10 (16-bit)	MCP33121D-10 (14-bit)	MCP33111D-10 (12-bit)
V_{REF}	0111111111111111	01111111111111	011111111111
$V_{REF} - 1 \text{ LSB}$	0111111111111111	01111111111111	011111111111
.	.	.	.
2 LSB	000000000000010	0000000000010	00000000010
1 LSB	000000000000001	0000000000001	00000000001
0	000000000000000	0000000000000	00000000000
-1 LSB	111111111111111	1111111111111	11111111111
-2 LSB	111111111111110	1111111111110	11111111110
.	.	.	.
$-V_{REF}$	100000000000000	1000000000000	10000000000
$< -V_{REF}$	100000000000000	1000000000000	10000000000

MCP33131D/21D/11D-10

7.0 DIGITAL SERIAL INTERFACE

The device has a SPI-compatible serial digital interface using four digital pins: CNVST, SDI, SDO and SCLK.

Figure 7-1 shows the connection diagram with the host device and Figure 7-2 shows the SPI-compatible serial interface timing diagram.

The SDI pin can be tied to the digital I/O interface supply voltage (DV_{IO}) or just maintain logic “High” level by the host. The CNVST pin is used for both chip select (\overline{CS}) and conversion-start control.

A rising edge on CNVST initiates the conversion process. Once the conversion is initiated, the device will complete the conversion regardless of the state of CNVST. This means the CNVST pin can be used for other purposes during t_{CNV} .

When the conversion is complete, the output is available at SDO by lowering CNVST. Data is sent MSB-first and changes on the falling edge of SCLK.

Output data can be sampled on either edge of SCLK. However, a digital host capturing data on the falling edge of SCLK can achieve a faster read out rate.

SDO returns to high-Z state after the last data bit is clocked out or when CNVST goes high, whichever occurs first.

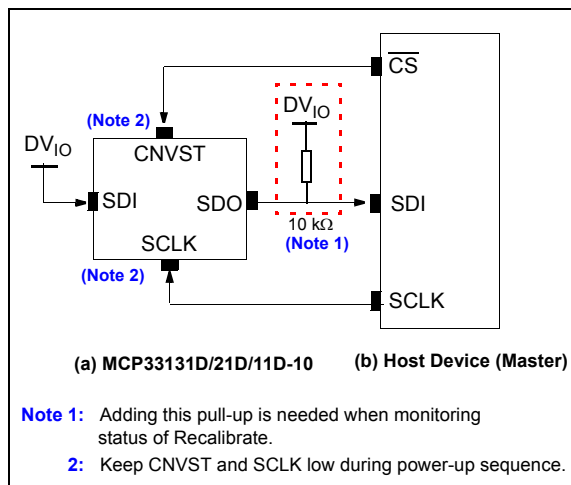

FIGURE 7-1: Digital Interface Connection Diagram.

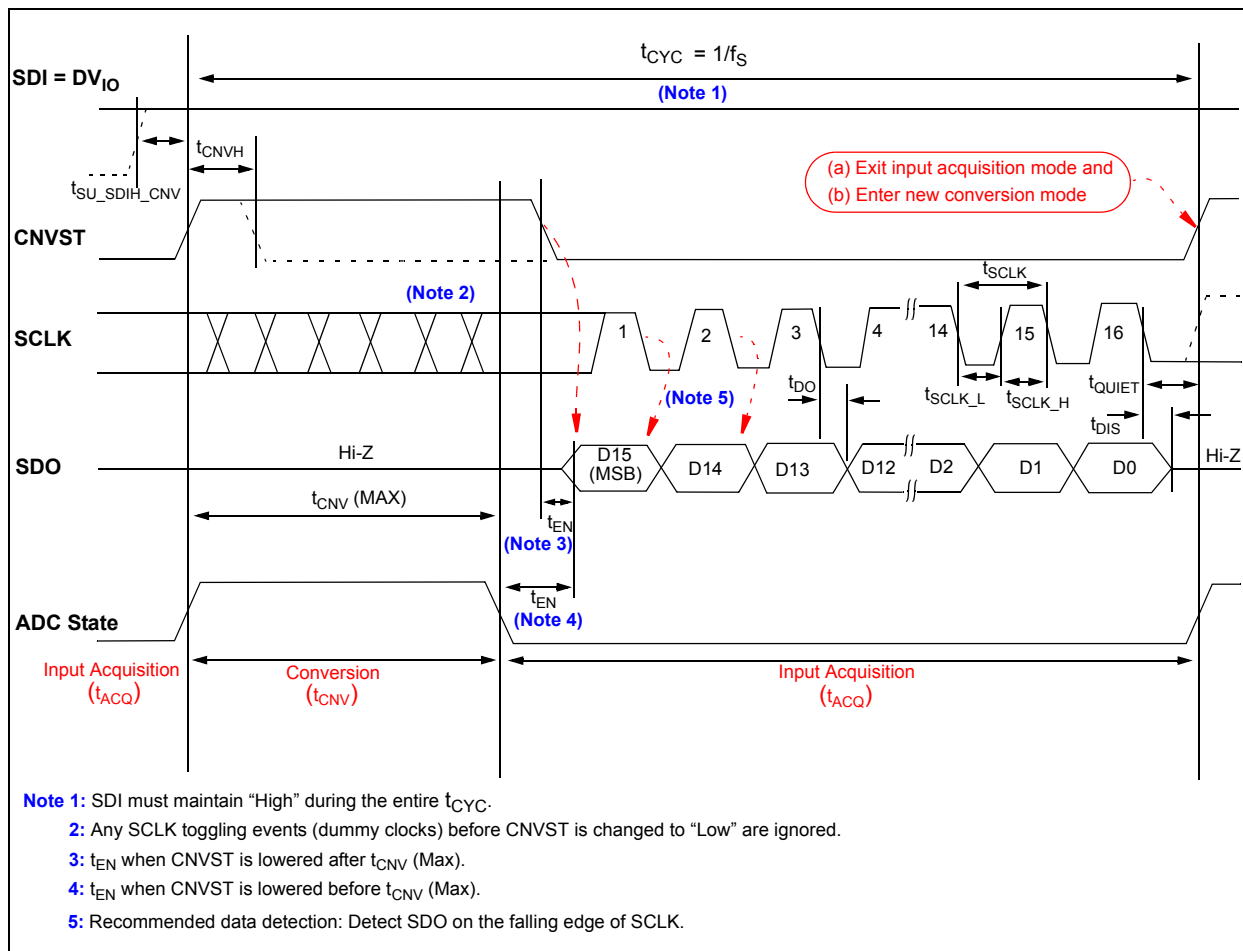

FIGURE 7-2: SPI™ Compatible Serial Interface Timing Diagram (16-bit device).

7.1 Recalibrate Command

The user may use the recalibrate command in the following cases:

- When the reference voltage was not fully settled during the first-power sequence.
- During operation, to ensure optimum performance across varying environment conditions, such as reference voltage and temperature.

A self-calibration is initiated by sending the recalibrate command. The host device sends a recalibrate command by transmitting 1024 SCLK pulses (including the clocks for data bits) while the device is in the acquisition phase (Standby).

The device drives SDO low during the recalibration procedure, and returns to high-Z once completed. The status of the recalibration procedure can be monitored by placing a pull-up on SDO, so that SDO goes high when the recalibration is complete.

Figure 7-3 shows the recalibrate command timing diagram. The calibration takes approximately 500 ms (t_{CAL}).

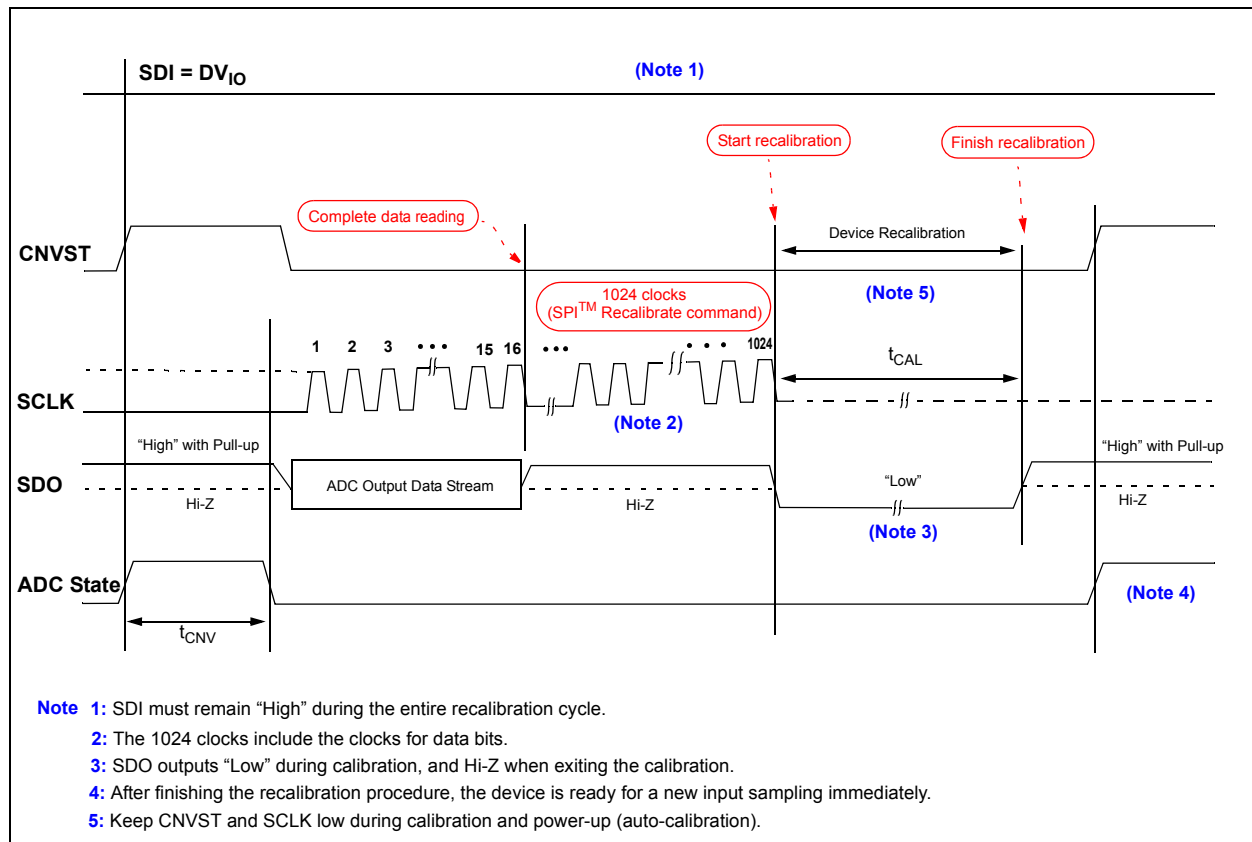

FIGURE 7-3: Recalibrate Command Timing Diagram.

Note: When the device performs a self-calibration, it is important to note that both AV_{DD} and the reference voltage (V_{REF}) must be stabilized for a correct calibration. This is also true when the device is first powered-up, the reference voltage (V_{REF}) must be stabilized before self-calibration begins. This means the V_{REF} must be provided prior to supplying AV_{DD} or within about 64 ms after supplying AV_{DD} .

MCP33131D/21D/11D-10

NOTES:

MCP33131D/21D/11D-10

8.0 DEVELOPMENT SUPPORT

Device Evaluation Board

Microchip offers a high speed/high precision SAR ADC evaluation platform which can be used to evaluate Microchip's latest high speed/high resolution SAR ADC products. The platform consists of an MCP331x1 evaluation board, a data capture board (PIC32MZ EF Curiosity Board), and a PC-based Graphical User Interface (GUI) software.

Figure 8-1 and Figure 8-2 show this evaluation tool. This evaluation platform allows users to quickly evaluate the ADC's performance for their specific application requirements.

Note: Contact Microchip Technology Inc. for the PIC32 MCU firmware and the MCP331x1 Evaluation Kit.

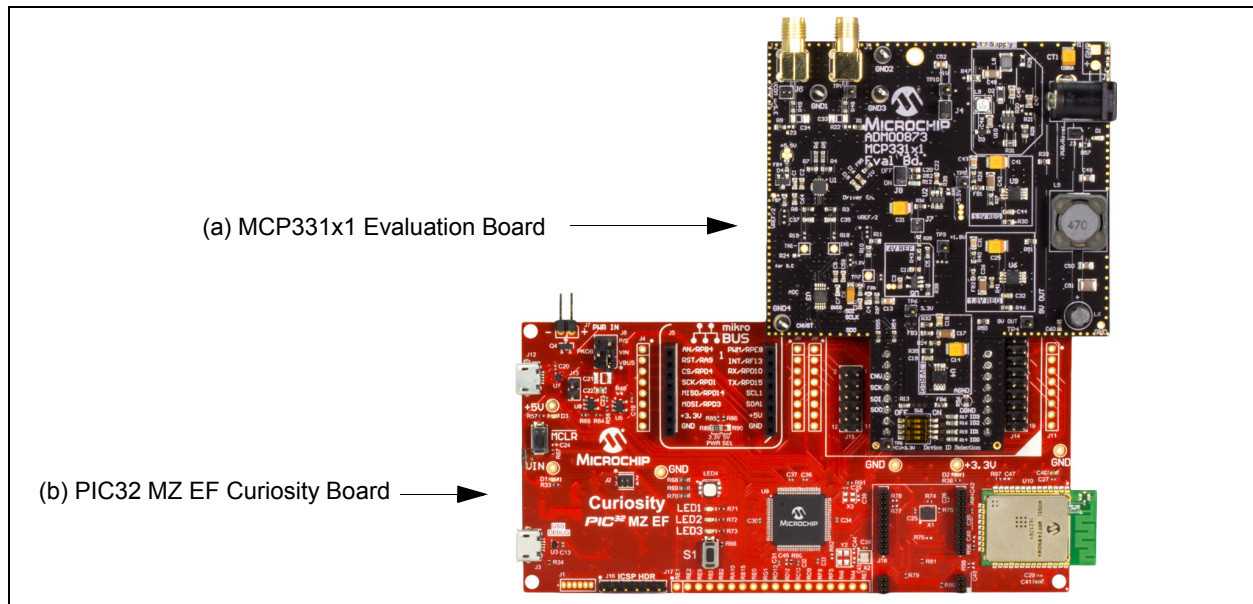

FIGURE 8-1: MCP331x1 Evaluation Kit.

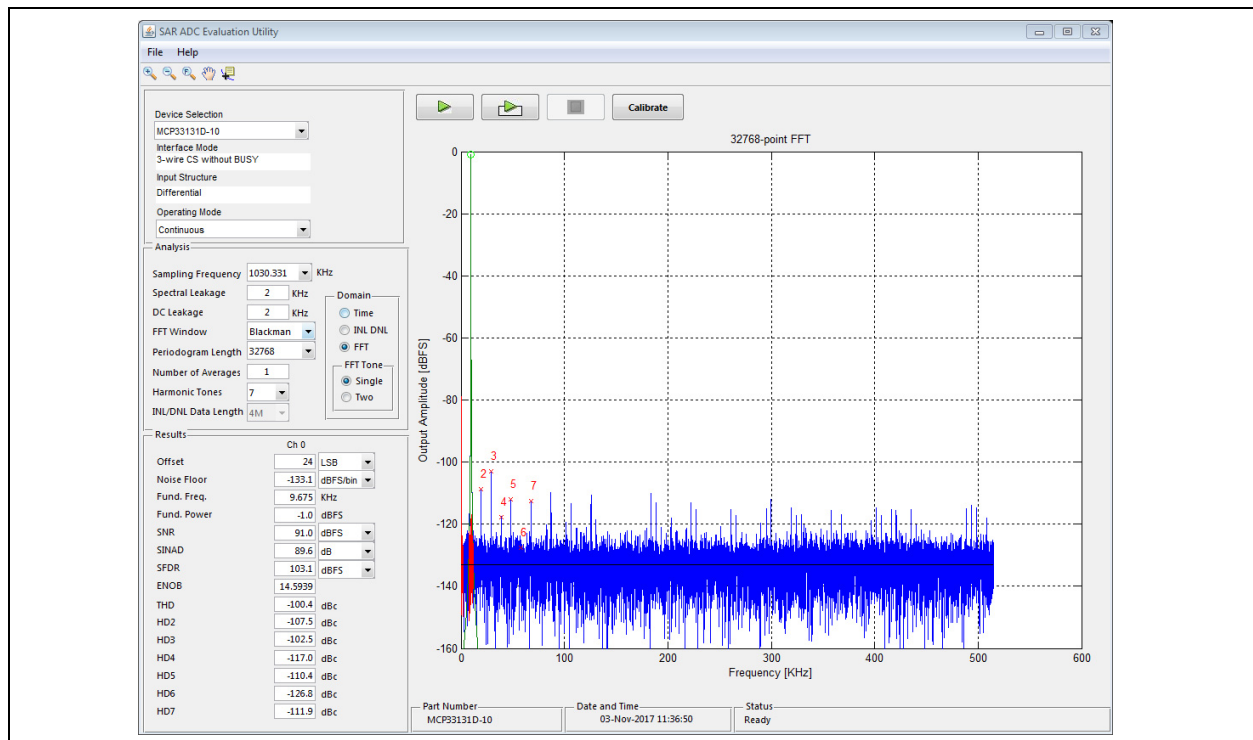

FIGURE 8-2: PC-Based Graphical User Interface Software.

MCP33131D/21D/11D-10

NOTES:

9.0 TERMINOLOGY

Analog Input Bandwidth (Full-Power Bandwidth)

The analog input frequency at which the spectral power of the fundamental frequency (as determined by FFT analysis) is reduced by 3 dB.

Aperture Delay or Sampling Delay

This is the time delay between the rising edge of the CNVST input and when the input signal is held for a conversion.

Differential Nonlinearity (DNL, No Missing Codes)

An ideal ADC exhibits code transitions that are exactly 1 LSB apart. DNL is the deviation from this ideal value. No missing codes to 16-bit resolution indicates that all 65,536 codes (16,384 codes for 14-bit, 4096 codes for 12-bit) must be present over all the operating conditions.

Integral Nonlinearity (INL)

INL is the maximum deviation of each individual code from an ideal straight line drawn from negative full scale through positive full scale.

Signal-to-Noise Ratio (SNR)

SNR is the ratio of the power of the fundamental (P_S) to the noise floor power (P_N), below the Nyquist frequency and excluding the power at DC and the first nine harmonics.

EQUATION 9-1:

$$SNR = 10 \log \left(\frac{P_S}{P_N} \right)$$

SNR is either given in units of dBc (dB to carrier), when the absolute power of the fundamental is used as the reference, or dBFS (dB to full-scale), when the power of the fundamental is extrapolated to the converter full-scale range.

Signal-to-Noise and Distortion (SINAD)

SINAD is the ratio of the power of the fundamental (P_S) to the power of all the other spectral components including noise (P_N) and distortion (P_D) below the Nyquist frequency, but excluding DC:

EQUATION 9-2:

$$\begin{aligned} SINAD &= 10 \log \left(\frac{P_S}{P_D + P_N} \right) \\ &= -10 \log \left[10^{\frac{SNR}{10}} - 10^{\frac{THD}{10}} \right] \end{aligned}$$

SINAD is either given in units of dBc (dB to carrier), when the absolute power of the fundamental is used as the reference, or dBFS (dB to full-scale), when the power of the fundamental is extrapolated to the converter full-scale range.

Effective Number of Bits (ENOB)

The effective number of bits for a sine wave input at a given input frequency can be calculated directly from its measured SINAD using the following formula:

EQUATION 9-3:

$$ENOB = \frac{SINAD - 1.76}{6.02}$$

Gain Error

Gain error is the deviation of the ADC's actual input full-scale range from its ideal value. The gain error is given as a percentage of the ideal input full-scale range. Gain error is usually expressed in LSB or as a percentage of full-scale range (%FSR).

Offset Error

The major carry transition should occur for an analog value of $\frac{1}{2}$ LSB below $A_{IN+} = A_{IN-}$. Offset error is defined as the deviation of the actual transition from that point.

Temperature Drift

The temperature drift for offset error and gain error specifies the maximum change from the initial (+25°C) value to the value at across the T_{MIN} to T_{MAX} range. The value is normalized by the reference voltage and expressed in $\mu V/^\circ C$ or ppm/ $^\circ C$.

Maximum Conversion Rate

The maximum clock rate at which parametric testing is performed.

Spurious-Free Dynamic Range (SFDR)

SFDR is the ratio of the power of the fundamental to the highest other spectral component (either spur or harmonic). SFDR is typically given in units of dBc (dB to carrier) or dBFS.

MCP33131D/21D/11D-10

Total Harmonic Distortion (THD)

THD is the ratio of the power of the fundamental (P_S) to the summed power of the first 13 harmonics (P_D).

EQUATION 9-4:

$$THD = 10\log\left(\frac{P_S}{P_D}\right)$$

THD is typically given in units of dBc (dB to carrier). THD is also shown by:

EQUATION 9-5:

$$THD = -20\log\frac{\sqrt{V_2^2 + V_3^2 + V_4^2 + \dots + V_n^2}}{V_1^2}$$

Where:

V_1 = RMS amplitude of the fundamental frequency

V_1 through V_n = Amplitudes of the second through n^{th} harmonics

Common-Mode Rejection Ratio (CMRR)

Common-mode rejection is the ability of a device to reject a signal that is common to both sides of a differential input pair. The common-mode signal can be an AC or DC signal or a combination of the two. CMRR is measured using the ratio of the differential signal gain to the common-mode signal gain and expressed in dB with the following equation:

EQUATION 9-6:

$$CMRR = 20\log\left(\frac{A_{DIFF}}{A_{CM}}\right)$$

Where:

A_{DIFF} = Δ Output Code/ Δ Differential Voltage

A_{DIFF} = Δ Output Code/ Δ Common-Mode Voltage

MCP33131D/21D/11D-10

10.0 PACKAGING INFORMATION

10.1 Package Marking Information

10-Lead MSOP (3x3 mm)

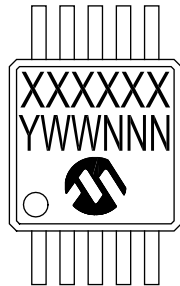

Example

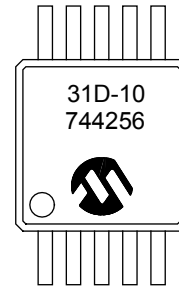

10-Lead TDFN (3x3x0.9 mm)

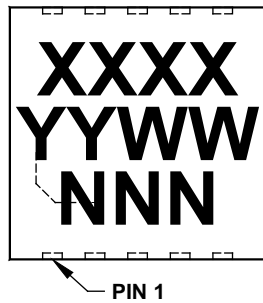

Example

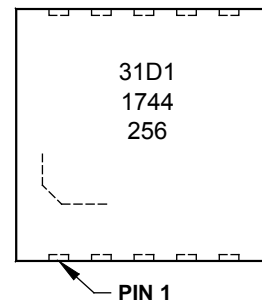

Legend:	XX...X	Customer-specific information
	Y	Year code (last digit of calendar year)
	YY	Year code (last 2 digits of calendar year)
	WW	Week code (week of January 1 is week '01')
	NNN	Alphanumeric traceability code
	(e3)	Pb-free JEDEC® designator for Matte Tin (Sn)
	*	This package is Pb-free. The Pb-free JEDEC designator (e3) can be found on the outer packaging for this package.
Note:	In the event the full Microchip part number cannot be marked on one line, it will be carried over to the next line, thus limiting the number of available characters for customer-specific information.	

MCP33131D/21D/11D-10

10-Lead Plastic Micro Small Outline Package (MS) [MSOP]

Note: For the most current package drawings, please see the Microchip Packaging Specification located at <http://www.microchip.com/packaging>

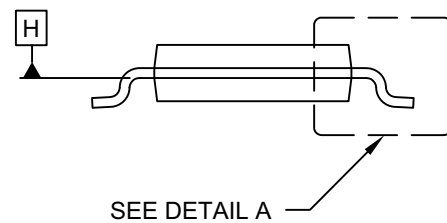
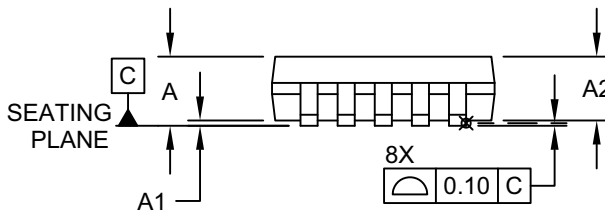
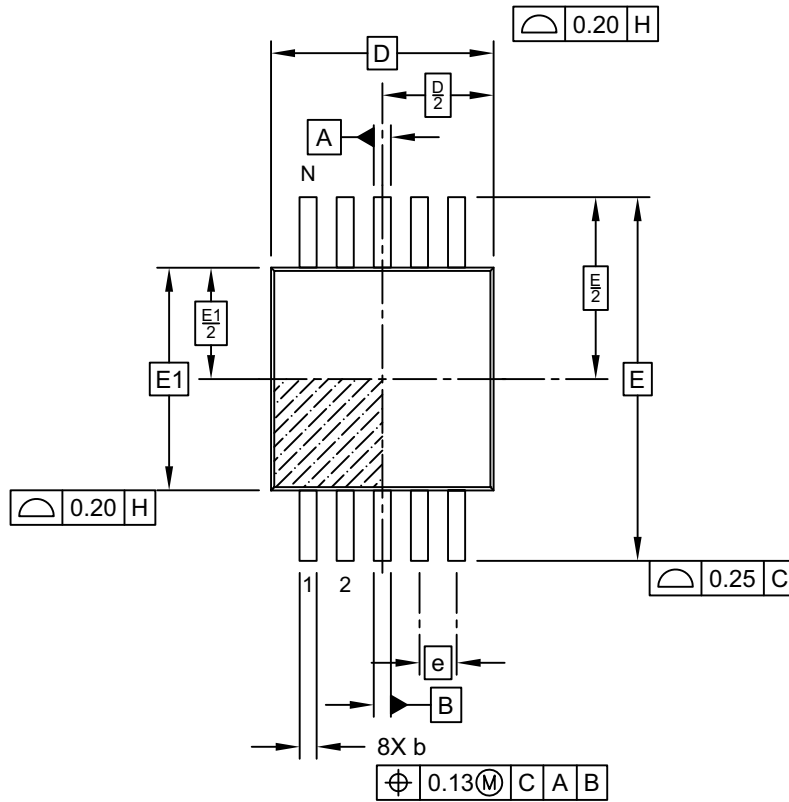

Microchip Technology Drawing C04-021D Sheet 1 of 2

MCP33131D/21D/11D-10

10-Lead Plastic Micro Small Outline Package (MS) [MSOP]

Note: For the most current package drawings, please see the Microchip Packaging Specification located at <http://www.microchip.com/packaging>

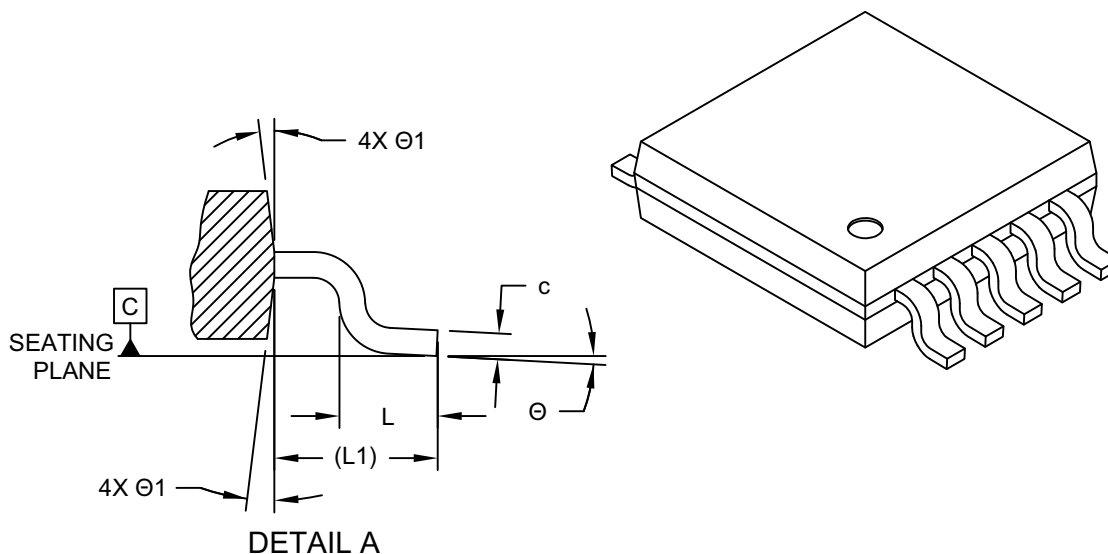

Dimension Limits	Units	MILLIMETERS		
		MIN	NOM	MAX
Number of Pins	N	10		
Pitch	e	0.50 BSC		
Overall Height	A	-	-	1.10
Molded Package Thickness	A2	0.75	0.85	0.95
Standoff	A1	0.00	-	0.15
Overall Width	E	4.90 BSC		
Molded Package Width	E1	3.00 BSC		
Overall Length	D	3.00 BSC		
Foot Length	L	0.40	0.60	0.80
Footprint	L1	0.95 REF		
Mold Draft Angle	Ø	0°	-	8°
Foot Angle	Ø1	5°	-	15°
Lead Thickness	c	0.08	-	0.23
Lead Width	b	0.15	-	0.33

Notes:

- Pin 1 visual index feature may vary, but must be located within the hatched area.
- Dimensions D and E1 do not include mold flash or protrusions. Mold flash or protrusions shall not exceed 0.15mm per side.
- Dimensioning and tolerancing per ASME Y14.5M.
 BSC: Basic Dimension. Theoretically exact value shown without tolerances.
 REF: Reference Dimension, usually without tolerance, for information purposes only.

Microchip Technology Drawing C04-021D Sheet 2 of 2

MCP33131D/21D/11D-10

10-Lead Plastic Micro Small Outline Package (MS) [MSOP]

Note: For the most current package drawings, please see the Microchip Packaging Specification located at <http://www.microchip.com/packaging>

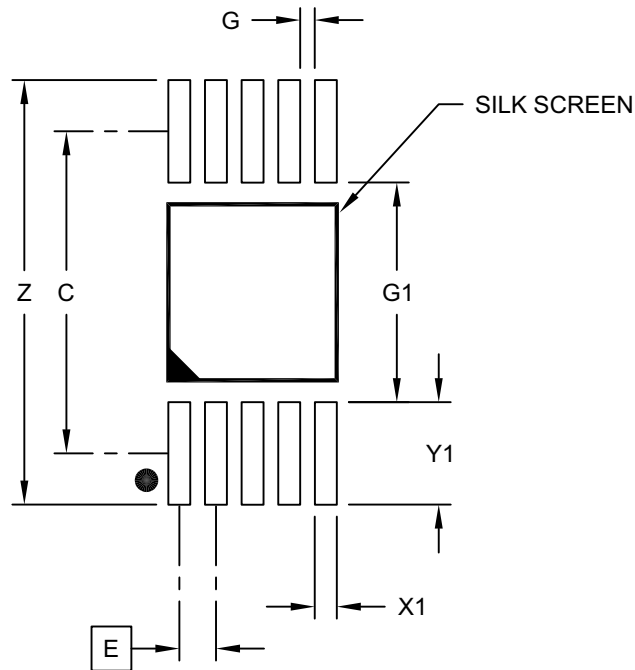

RECOMMENDED LAND PATTERN

Dimension Limits	Units	MILLIMETERS		
		MIN	NOM	MAX
Contact Pitch	E	0.50 BSC		
Contact Pad Spacing	C	4.40		
Overall Width	Z			5.80
Contact Pad Width (X10)	X1			0.30
Contact Pad Length (X10)	Y1			1.40
Distance Between Pads (X5)	G1	3.00		
Distance Between Pads (X8)	G	0.20		

Notes:

1. Dimensioning and tolerancing per ASME Y14.5M

BSC: Basic Dimension. Theoretically exact value shown without tolerances.

Microchip Technology Drawing No. C04-2021B

MCP33131D/21D/11D-10

10-Lead Thin Plastic Dual Flat, No Lead Package (MN) - 3x3x0.8mm Body [TDFN]

Note: For the most current package drawings, please see the Microchip Packaging Specification located at <http://www.microchip.com/packaging>

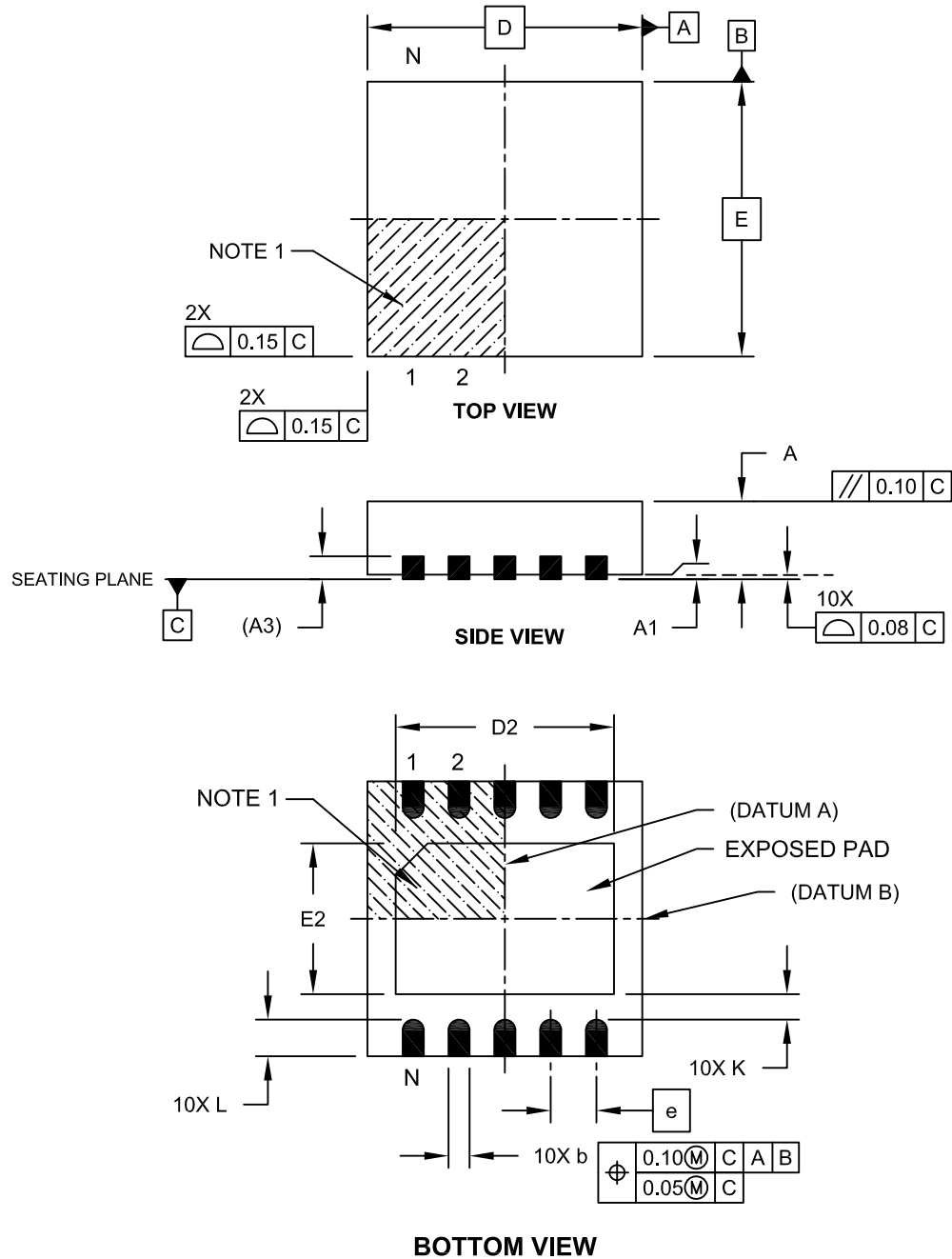

Microchip Technology Drawing C04-185A Sheet 1 of 2

MCP33131D/21D/11D-10

10-Lead Thin Plastic Dual Flat, No Lead Package (MN) - 3x3x0.8mm Body [TDFN]

Note: For the most current package drawings, please see the Microchip Packaging Specification located at <http://www.microchip.com/packaging>

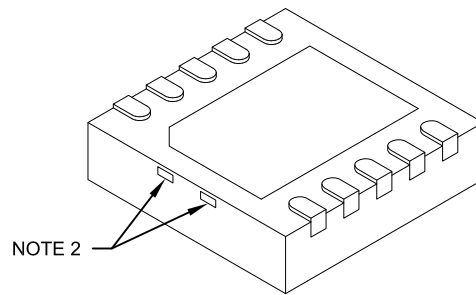

Dimension Limits	Units	MILLIMETERS		
		MIN	NOM	MAX
Number of Pins	N	10		
Pitch	e	0.50 BSC		
Overall Height	A	0.70	0.75	0.80
Standoff	A1	0.00	0.02	0.05
Contact Thickness	A3	0.20 REF		
Overall Length	D	3.00 BSC		
Exposed Pad Length	D2	2.20	2.30	2.35
Overall Width	E	3.00 BSC		
Exposed Pad Width	E2	1.55	1.65	1.70
Contact Width	b	0.18	0.25	0.30
Contact Length	L	0.30	0.40	0.50
Contact-to-Exposed Pad	K	0.20	-	-

Notes:

1. Pin 1 visual index feature may vary, but must be located within the hatched area.
2. Package may have one or more exposed tie bars at ends.
3. Package is saw singulated
4. Dimensioning and tolerancing per ASME Y14.5M
BSC: Basic Dimension. Theoretically exact value shown without tolerances.
REF: Reference Dimension, usually without tolerance, for information purposes only.

Microchip Technology Drawing No. C04-0185A Sheet 2 of 2

MCP33131D/21D/11D-10

APPENDIX A: REVISION HISTORY

Revision A (March 2018)

- Original release of this document

MCP33131D/21D/11D-10

NOTES:

MCP33131D/21D/11D-10

PRODUCT IDENTIFICATION SYSTEM

To order or obtain information, e.g., on pricing or delivery, refer to the factory or the listed sales office.

<u>PART NO.</u>	<u>X</u>	<u>-XX</u>	<u>X</u>	<u>=X</u>	<u>ΔXX</u>	
Device	Input Type	Sample Rate	Tape and Reel	Temperature Range	Package	Examples:
<p>Device: MCP33131D-10: 16-Bit Differential Input SAR ADC MCP33121D-10: 14-Bit Differential Input SAR ADC MCP33111D-10: 12-Bit Differential Input SAR ADC</p> <p>Input Type: D: Differential Input</p> <p>Sample Rate: 10 = 1 Msps</p> <p>Tape and Reel Option: Blank = Standard packaging (tube or tray) T = Tape and Reel</p> <p>Temperature Range: I = -40°C to +85°C (Industrial)</p> <p>Package: MS = Plastic Micro Small Outline Package (MSOP), 10-Lead MN = Thin Plastic Dual Flat No Lead Package (TDFN), 10-Lead (Note 1)</p> <p>Note 1: Contact Microchip Technology Inc. for availability.</p>						<p>a) MCP33131D-10-I/MS: 1 Msps, 10LD MSOP, 16-bit device</p> <p>b) MCP33131D-10T-I/MS: 1 Msps, 10LD MSOP, Tape and Reel, 16-bit device</p> <p>c) MCP33131D-10-I/MN: 1 Msps, 10LD TDFN, 16-bit device</p> <p>d) MCP33131D-10T-I/MN: 1 Msps, 10LD TDFN, Tape and Reel, 16-bit device</p> <p>e) MCP33121D-10-I/MS: 1 Msps, 10LD MSOP, 14-bit device</p> <p>f) MCP33121D-10T-I/MS: 1 Msps, 10LD MSOP, Tape and Reel, 14-bit device</p> <p>g) MCP33121D-10-I/MN: 1 Msps, 10LD TDFN, 14-bit device</p> <p>h) MCP33121D-10T-I/MN: 1 Msps, 10LD TDFN, Tape and Reel, 14-bit device</p> <p>i) MCP33111D-10-I/MS: 1 Msps, 10LD MSOP, 12-bit device</p> <p>j) MCP33111D-10T-I/MS: 1 Msps, 10LD MSOP, Tape and Reel, 12-bit device</p> <p>k) MCP33111D-10-I/MN: 1 Msps, 10LD TDFN, 12-bit device</p> <p>l) MCP33111D-10T-I/MN: 1 Msps, 10LD TDFN, Tape and Reel, 12-bit device</p> <p>Note 1: Tape and Reel identifier appears only in the catalog part number description. This identifier is used for ordering purposes and is not printed on the device package. Check with your Microchip Sales Office for package availability with the Tape and Reel option.</p>

Note the following details of the code protection feature on Microchip devices:

- Microchip products meet the specification contained in their particular Microchip Data Sheet.
- Microchip believes that its family of products is one of the most secure families of its kind on the market today, when used in the intended manner and under normal conditions.
- There are dishonest and possibly illegal methods used to breach the code protection feature. All of these methods, to our knowledge, require using the Microchip products in a manner outside the operating specifications contained in Microchip's Data Sheets. Most likely, the person doing so is engaged in theft of intellectual property.
- Microchip is willing to work with the customer who is concerned about the integrity of their code.
- Neither Microchip nor any other semiconductor manufacturer can guarantee the security of their code. Code protection does not mean that we are guaranteeing the product as “unbreakable.”

Code protection is constantly evolving. We at Microchip are committed to continuously improving the code protection features of our products. Attempts to break Microchip's code protection feature may be a violation of the Digital Millennium Copyright Act. If such acts allow unauthorized access to your software or other copyrighted work, you may have a right to sue for relief under that Act.

Information contained in this publication regarding device applications and the like is provided only for your convenience and may be superseded by updates. It is your responsibility to ensure that your application meets with your specifications. MICROCHIP MAKES NO REPRESENTATIONS OR WARRANTIES OF ANY KIND WHETHER EXPRESS OR IMPLIED, WRITTEN OR ORAL, STATUTORY OR OTHERWISE, RELATED TO THE INFORMATION, INCLUDING BUT NOT LIMITED TO ITS CONDITION, QUALITY, PERFORMANCE, MERCHANTABILITY OR FITNESS FOR PURPOSE. Microchip disclaims all liability arising from this information and its use. Use of Microchip devices in life support and/or safety applications is entirely at the buyer's risk, and the buyer agrees to defend, indemnify and hold harmless Microchip from any and all damages, claims, suits, or expenses resulting from such use. No licenses are conveyed, implicitly or otherwise, under any Microchip intellectual property rights unless otherwise stated.

Microchip received ISO/TS-16949:2009 certification for its worldwide headquarters, design and wafer fabrication facilities in Chandler and Tempe, Arizona; Gresham, Oregon and design centers in California and India. The Company's quality system processes and procedures are for its PIC® MCUs and dsPIC® DSCs, KEELOQ® code hopping devices, Serial EEPROMs, microperipherals, nonvolatile memory and analog products. In addition, Microchip's quality system for the design and manufacture of development systems is ISO 9001:2000 certified.

**QUALITY MANAGEMENT SYSTEM
CERTIFIED BY DNV
= ISO/TS 16949 =**

Trademarks

The Microchip name and logo, the Microchip logo, AnyRate, AVR, AVR logo, AVR Freaks, BeaconThings, BitCloud, chipKIT, chipKIT logo, CryptoMemory, CryptoRF, dsPIC, FlashFlex, flexPWR, Helder, JukeBlox, KEELOQ, KEELOQ logo, Kleer, LANCheck, LINK MD, maXStylus, maXTouch, MediaLB, megaAVR, MOST, MOST logo, MPLAB, OptoLyzer, PIC, picoPower, PICSTART, PIC32 logo, Prochip Designer, QTouch, RightTouch, SAM-BA, SpyNIC, SST, SST Logo, SuperFlash, tinyAVR, UNI/O, and XMEGA are registered trademarks of Microchip Technology Incorporated in the U.S.A. and other countries.

ClockWorks, The Embedded Control Solutions Company, EtherSynch, Hyper Speed Control, HyperLight Load, IntelliMOS, mTouch, Precision Edge, and Quiet-Wire are registered trademarks of Microchip Technology Incorporated in the U.S.A.

Adjacent Key Suppression, AKS, Analog-for-the-Digital Age, Any Capacitor, AnyIn, AnyOut, BodyCom, CodeGuard, CryptoAuthentication, CryptoCompanion, CryptoController, dsPICDEM, dsPICDEM.net, Dynamic Average Matching, DAM, ECAN, EtherGREEN, In-Circuit Serial Programming, ICSP, Inter-Chip Connectivity, JitterBlocker, KleerNet, KleerNet logo, Mindi, MiWi, motorBench, MPASM, MPF, MPLAB Certified logo, MPLIB, MPLINK, MultiTRAK, NetDetach, Omniscient Code Generation, PICDEM, PICDEM.net, PICkit, PICtail, PureSilicon, QMatrix, RightTouch logo, REAL ICE, Ripple Blocker, SAM-ICE, Serial Quad I/O, SMART-I.S., SQI, SuperSwitcher, SuperSwitcher II, Total Endurance, TSHARC, USBCheck, VariSense, ViewSpan, WiperLock, Wireless DNA, and ZENA are trademarks of Microchip Technology Incorporated in the U.S.A. and other countries.

SQTP is a service mark of Microchip Technology Incorporated in the U.S.A.

Silicon Storage Technology is a registered trademark of Microchip Technology Inc. in other countries.

GestIC is a registered trademark of Microchip Technology Germany II GmbH & Co. KG, a subsidiary of Microchip Technology Inc., in other countries.

All other trademarks mentioned herein are property of their respective companies.

© 2018, Microchip Technology Incorporated, All Rights Reserved.

ISBN: 978-1-5224-2774-2



MICROCHIP

Worldwide Sales and Service

AMERICAS

Corporate Office
2355 West Chandler Blvd.
Chandler, AZ 85224-6199
Tel: 480-792-7200
Fax: 480-792-7277
Technical Support:
<http://www.microchip.com/support>
Web Address:
www.microchip.com

Atlanta

Duluth, GA
Tel: 678-957-9614
Fax: 678-957-1455

Austin, TX

Tel: 512-257-3370

Boston

Westborough, MA
Tel: 774-760-0087
Fax: 774-760-0088

Chicago

Itasca, IL
Tel: 630-285-0071
Fax: 630-285-0075

Dallas

Addison, TX
Tel: 972-818-7423
Fax: 972-818-2924

Detroit

Novi, MI
Tel: 248-848-4000

Houston, TX

Tel: 281-894-5983

Indianapolis

Noblesville, IN
Tel: 317-773-8323
Fax: 317-773-5453
Tel: 317-536-2380

Los Angeles

Mission Viejo, CA
Tel: 949-462-9523
Fax: 949-462-9608
Tel: 951-273-7800

Raleigh, NC

Tel: 919-844-7510

New York, NY

Tel: 631-435-6000

San Jose, CA

Tel: 408-735-9110
Tel: 408-436-4270

Canada - Toronto

Tel: 905-695-1980
Fax: 905-695-2078

ASIA/PACIFIC

Australia - Sydney
Tel: 61-2-9868-6733

China - Beijing
Tel: 86-10-8569-7000

China - Chengdu
Tel: 86-28-8665-5511

China - Chongqing
Tel: 86-23-8980-9588

China - Dongguan
Tel: 86-769-8702-9880

China - Guangzhou
Tel: 86-20-8755-8029

China - Hangzhou
Tel: 86-571-8792-8115

China - Hong Kong SAR
Tel: 852-2943-5100

China - Nanjing
Tel: 86-25-8473-2460

China - Qingdao
Tel: 86-532-8502-7355

China - Shanghai
Tel: 86-21-3326-8000

China - Shenyang
Tel: 86-24-2334-2829

China - Shenzhen
Tel: 86-755-8864-2200

China - Suzhou
Tel: 86-186-6233-1526

China - Wuhan
Tel: 86-27-5980-5300

China - Xian
Tel: 86-29-8833-7252

China - Xiamen
Tel: 86-592-2388138

China - Zhuhai
Tel: 86-756-3210040

ASIA/PACIFIC

India - Bangalore
Tel: 91-80-3090-4444

India - New Delhi
Tel: 91-11-4160-8631

India - Pune
Tel: 91-20-4121-0141

Japan - Osaka
Tel: 81-6-6152-7160

Japan - Tokyo
Tel: 81-3-6880-3770

Korea - Daegu
Tel: 82-53-744-4301

Korea - Seoul
Tel: 82-2-554-7200

Malaysia - Kuala Lumpur
Tel: 60-3-7651-7906

Malaysia - Penang
Tel: 60-4-227-8870

Philippines - Manila
Tel: 63-2-634-9065

Singapore
Tel: 65-6334-8870

Taiwan - Hsin Chu
Tel: 886-3-577-8366

Taiwan - Kaohsiung
Tel: 886-7-213-7830

Taiwan - Taipei
Tel: 886-2-2508-8600

Thailand - Bangkok
Tel: 66-2-694-1351

Vietnam - Ho Chi Minh
Tel: 84-28-5448-2100

EUROPE

Austria - Wels
Tel: 43-7242-2244-39
Fax: 43-7242-2244-393

Denmark - Copenhagen
Tel: 45-4450-2828
Fax: 45-4485-2829

Finland - Espoo
Tel: 358-9-4520-820

France - Paris
Tel: 33-1-69-53-63-20
Fax: 33-1-69-30-90-79

Germany - Garching
Tel: 49-8931-9700

Germany - Haan
Tel: 49-2129-3766400

Germany - Heilbronn
Tel: 49-7131-67-3636

Germany - Karlsruhe
Tel: 49-721-625370

Germany - Munich
Tel: 49-89-627-144-0
Fax: 49-89-627-144-44

Germany - Rosenheim
Tel: 49-8031-354-560

Israel - Ra'anana
Tel: 972-9-744-7705

Italy - Milan
Tel: 39-0331-742611
Fax: 39-0331-466781

Italy - Padova
Tel: 39-049-7625286

Netherlands - Drunen
Tel: 31-416-690399
Fax: 31-416-690340

Norway - Trondheim
Tel: 47-7289-7561

Poland - Warsaw
Tel: 48-22-3325737

Romania - Bucharest
Tel: 40-21-407-87-50

Spain - Madrid
Tel: 34-91-708-08-90
Fax: 34-91-708-08-91

Sweden - Gothenberg
Tel: 46-31-704-60-40

Sweden - Stockholm
Tel: 46-8-5090-4654

UK - Wokingham
Tel: 44-118-921-5800
Fax: 44-118-921-5820