



N-Channel Enhancement-Mode Vertical DMOS FET

Features

- ▶ Low threshold (1.6V max.)
- ▶ High input impedance
- ▶ Low input capacitance
- ▶ Fast switching speeds
- ▶ Low on-resistance
- ▶ Free from secondary breakdown
- ▶ Low input and output leakage

Applications

- ▶ Logic level interfaces – ideal for TTL and CMOS
- ▶ Solid state relays
- ▶ Battery operated systems
- ▶ Photo voltaic drives
- ▶ Analog switches
- ▶ General purpose line drivers
- ▶ Telecom switches

General Description

This low threshold, enhancement-mode (normally-off) transistor utilizes a vertical DMOS structure and Supertex’s well-proven, silicon-gate manufacturing process. This combination produces a device with the power handling capabilities of bipolar transistors and with the high input impedance and positive temperature coefficient inherent in MOS devices. Characteristic of all MOS structures, this device is free from thermal runaway and thermally-induced secondary breakdown.

Supertex’s vertical DMOS FETs are ideally suited to a wide range of switching and amplifying applications where very low threshold voltage, high breakdown voltage, high input impedance, low input capacitance, and fast switching speeds are desired.

Ordering Information

Part Number	Package Option	Packing
TN0104N3-G	TO-92	1000/Bag
TN0104N3-G P002	TO-92	2000/Reel
TN0104N3-G P003		
TN0104N3-G P005		
TN0104N3-G P013		
TN0104N3-G P014		
TN0104N8-G	TO-243AA (SOT-89)	2000/Reel

-G denotes a lead (Pb)-free / RoHS compliant package.
Contact factory for Wafer / Die availability.
Devices in Wafer / Die form are lead (Pb)-free / RoHS compliant.

Absolute Maximum Ratings

Parameter	Value
Drain-to-source voltage	BV_{DSS}
Drain-to-gate voltage	BV_{DGS}
Gate-to-source voltage	$\pm 20V$
Operating and storage temperature	$-55^{\circ}C$ to $+150^{\circ}C$

Absolute Maximum Ratings are those values beyond which damage to the device may occur. Functional operation under these conditions is not implied. Continuous operation of the device at the absolute rating level may affect device reliability. All voltages are referenced to device ground.

Typical Thermal Resistance

Package	θ_{ja}
TO-92	$132^{\circ}C/W$
TO-243AA (SOT-89)	$133^{\circ}C/W$

Product Summary

BV_{DSX}/BV_{DGX}	$R_{DS(ON)}$ (max)	I_{DSS} (min)
40V	1.8Ω	2.0A

Pin Configuration

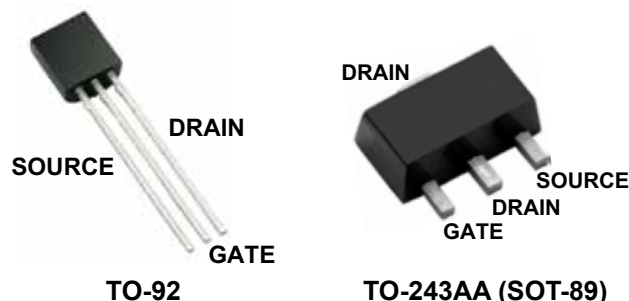

Product Marking



YY = Year Sealed
WW = Week Sealed
_____ = “Green” Packaging

Package may or may not include the following marks: Si or **TO-92**



W = Code for Week Sealed
_____ = “Green” Packaging

Package may or may not include the following marks: Si or **TO-243AA (SOT-89)**

Thermal Characteristics

Package	I_D (continuous) [†]	I_D (pulsed)	Power Dissipation @ $T_c = 25^\circ\text{C}$	I_{DR} [†]	I_{DRM}
TO-92	450mA	2.40A	1.0W	450mA	2.40A
TO-243AA (SOT-89)	630mA	2.90A	1.6W [‡]	630mA	2.90A

Notes:

[†] I_D (continuous) is limited by max rated T_j .

[‡] $T_A = 25^\circ\text{C}$. Mounted on FR5 Board, 25mm x 25mm x 1.57mm. Significant P_D increase possible on ceramic substrate.

Electrical Characteristics ($T_A = 25^\circ\text{C}$ unless otherwise specified)

Sym	Parameter	Min	Typ	Max	Units	Conditions		
BV_{DSS}	Drain-to-source breakdown voltage	40	-	-	V	$V_{GS} = 0V, I_D = 1.0mA$		
$V_{GS(th)}$	Gate threshold voltage	0.6	-	1.6	V	$V_{GS} = V_{DS}, I_D = 500\mu A$		
$\Delta V_{GS(th)}$	Change in $V_{GS(th)}$ with temperature	-	-3.8	-5.0	mV/ $^\circ\text{C}$	$V_{GS} = V_{DS}, I_D = 1.0mA$		
I_{GSS}	Gate body leakage	-	0.1	100	nA	$V_{GS} = \pm 20V, V_{DS} = 0V$		
I_{DSS}	Zero gate voltage drain current	-	-	1.0	μA	$V_{GS} = 0V, V_{DS} = \text{Max Rating}$		
		-	-	100		$V_{DS} = 0.8 \text{ Max Rating}, V_{GS} = 0V, T_A = 125^\circ\text{C}$		
$I_{D(ON)}$	On-state drain current	-	0.35	-	A	$V_{GS} = 3.0V, V_{DS} = 20V$		
		0.5	1.1	-		$V_{GS} = 5.0V, V_{DS} = 20V$		
		2.0	2.6	-		$V_{GS} = 10V, V_{DS} = 20V$		
$R_{DS(ON)}$	Static drain-to-source on-state resistance	Both packages		-	5.0	-	$V_{GS} = 3.0V, I_D = 50mA$	
				-	2.3	2.5	$V_{GS} = 5.0V, I_D = 250mA$	
		TO-92		-	1.5	1.8	Ω	$V_{GS} = 10V, I_D = 1.0A$
		TO-243AA		-	-	2.0		
$\Delta R_{DS(ON)}$	Change in $R_{DS(ON)}$ with temperature	-	0.7	1.0	%/ $^\circ\text{C}$	$V_{GS} = 10V, I_D = 1.0A$		
G_{FS}	Forward transductance	340	450	-	mmho	$V_{DS} = 20V, I_D = 500mA$		
C_{ISS}	Input capacitance	-	-	70	pF	$V_{GS} = 0V,$ $V_{DS} = 20V,$ $f = 1.0MHz$		
C_{OSS}	Common source output capacitance	-	-	50				
C_{RSS}	Reverse transfer capacitance	-	-	15				
$t_{d(ON)}$	Turn-on delay time	-	3.0	5.0	ns	$V_{DD} = 20V,$ $I_D = 1.0A,$ $R_{GEN} = 25\Omega$		
t_r	Rise time	-	7.0	8.0				
$t_{d(OFF)}$	Turn-off delay time	-	6.0	9.0				
t_f	Fall time	-	5.0	8.0				
V_{SD}	Diode forward voltage drop	TO-92		-	1.2	1.8	$V_{GS} = 0V, I_{SD} = 1.0A$	
		TO-243AA		-	-	2.0	$V_{GS} = 0V, I_{SD} = 0.5A$	
t_{rr}	Reverse recovery time	-	300	-	ns	$V_{GS} = 0V, I_{SD} = 1.0A$		

Notes:

- All D.C. parameters 100% tested at 25°C unless otherwise stated. (Pulse test: 300 μs pulse, 2% duty cycle.)
- All A.C. parameters sample tested.

Switching Waveforms and Test Circuit

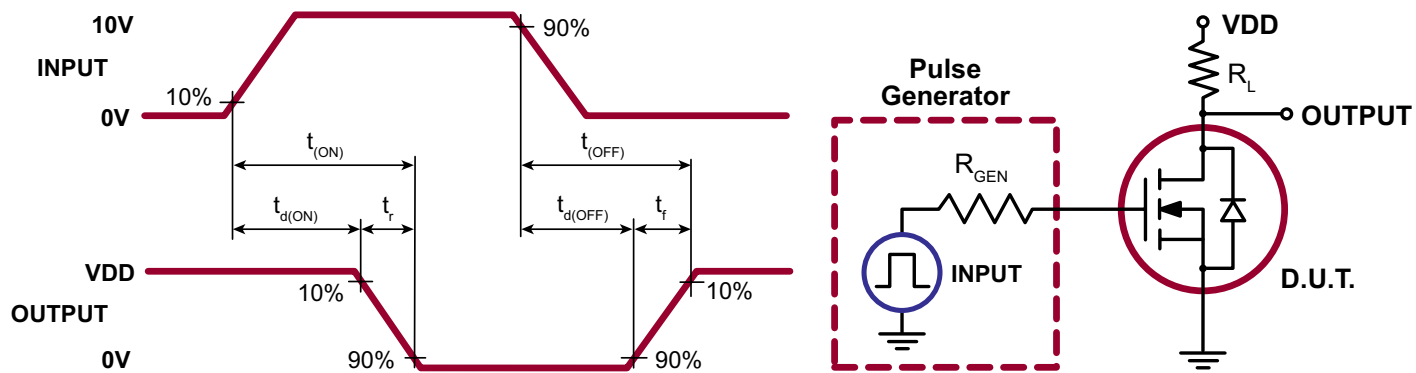

Typical Performance Curves

Output Characteristics

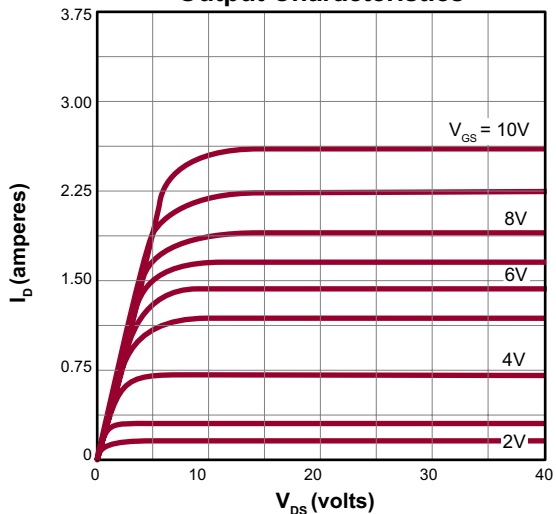

Saturation Characteristics

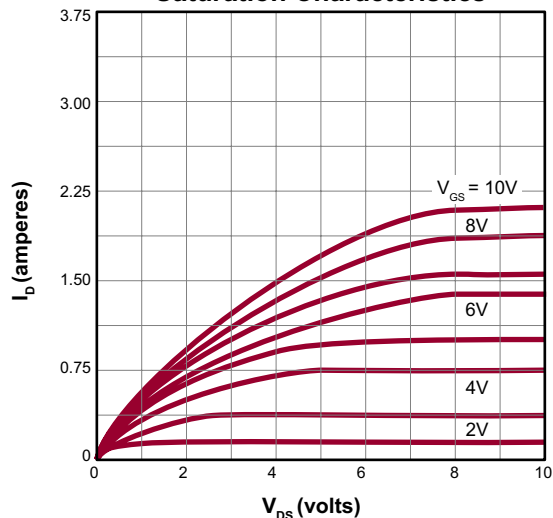

Transconductance vs. Drain Current

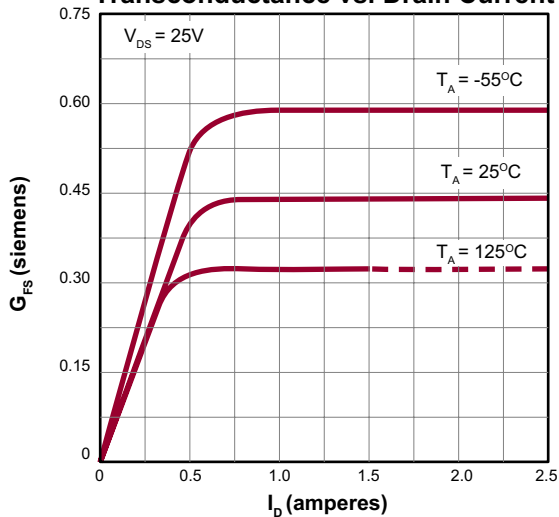

Power Dissipation vs. Case Temperature

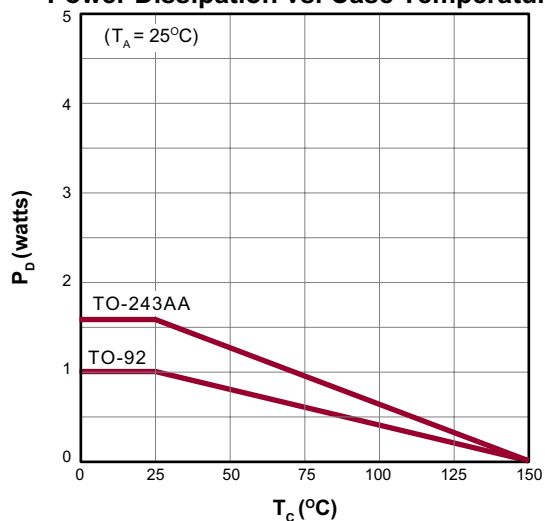

Maximum Rated Safe Operating Area

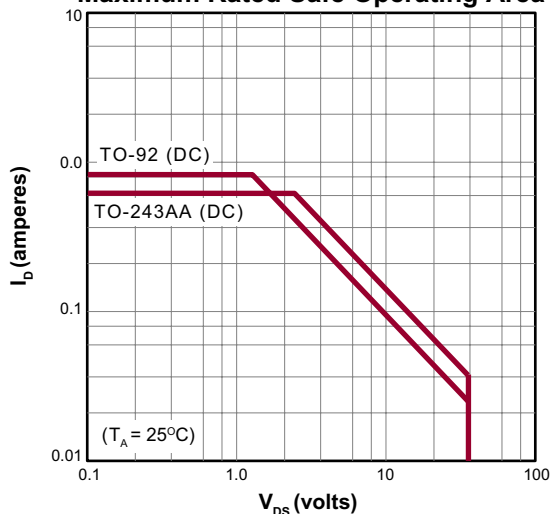

Thermal Response Characteristics

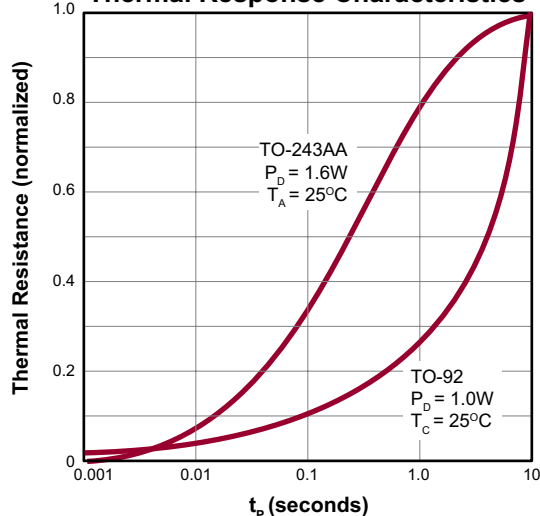

Typical Performance Curves (cont.)

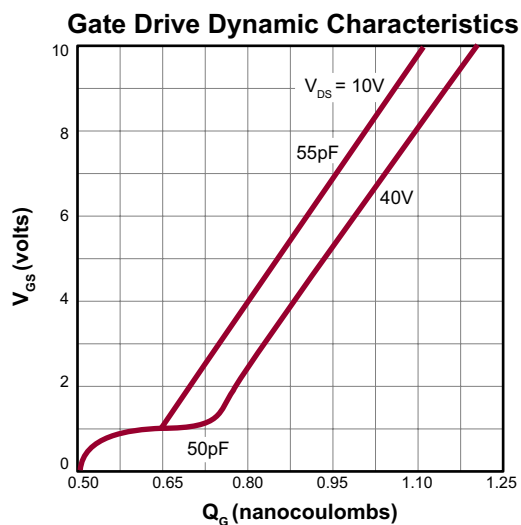
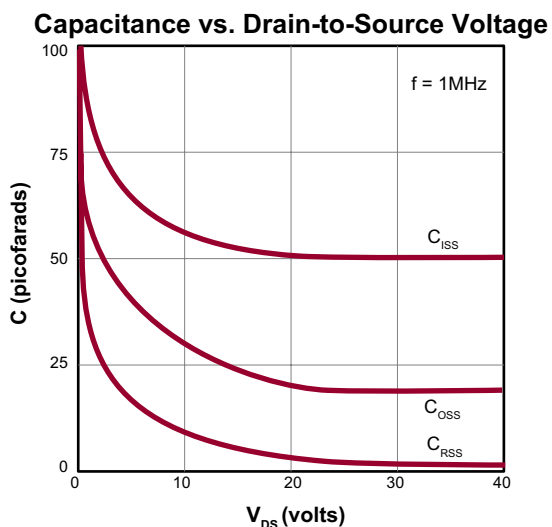
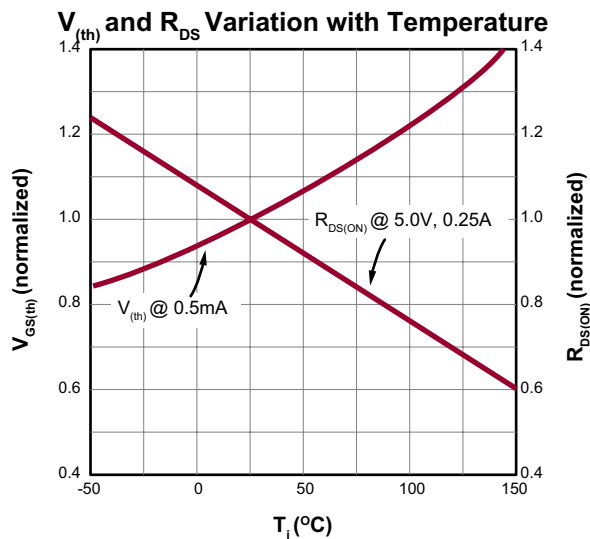
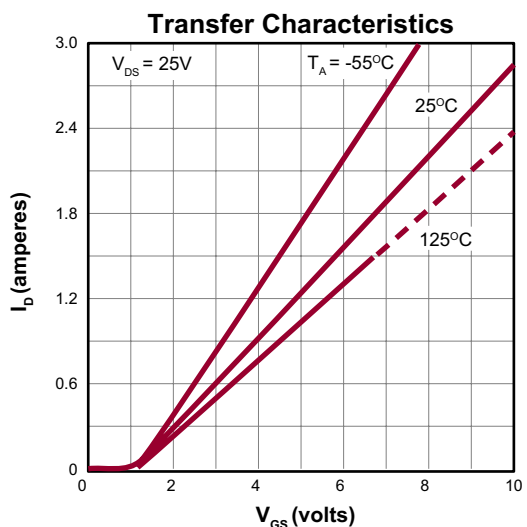
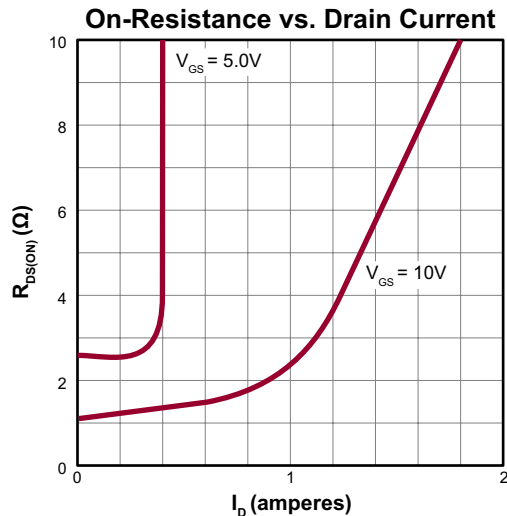
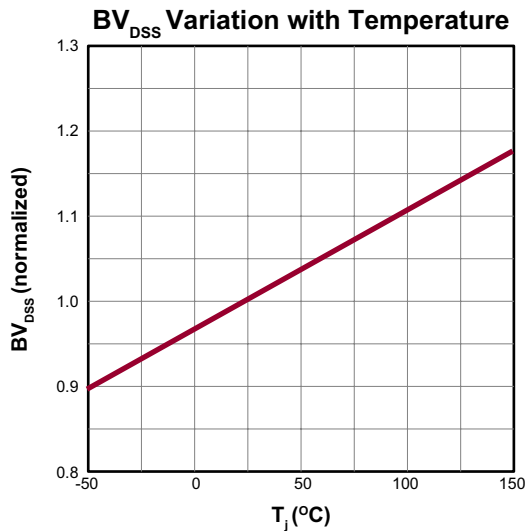

3-Lead TO-92 Package Outline (N3)

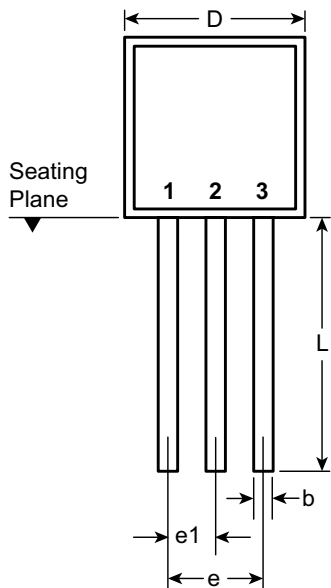

Front View

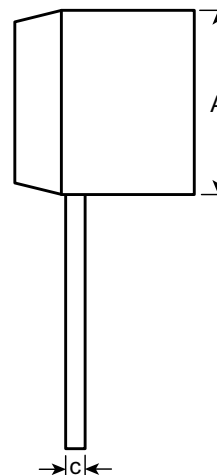

Side View

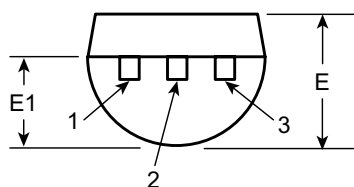

Bottom View

Symbol	A	b	c	D	E	E1	e	e1	L
Dimensions (inches)	MIN	.170	.014 [†]	.175	.125	.080	.095	.045	.500
	NOM	-	-	-	-	-	-	-	-
	MAX	.210	.022 [†]	.022 [†]	.205	.165	.105	.105	.610*

JEDEC Registration TO-92.

* This dimension is not specified in the JEDEC drawing.

† This dimension differs from the JEDEC drawing.

Drawings not to scale.

Supertex Doc.#: DSPD-3TO92N3, Version E041009.

3-Lead TO-243AA (SOT-89) Package Outline (N8)

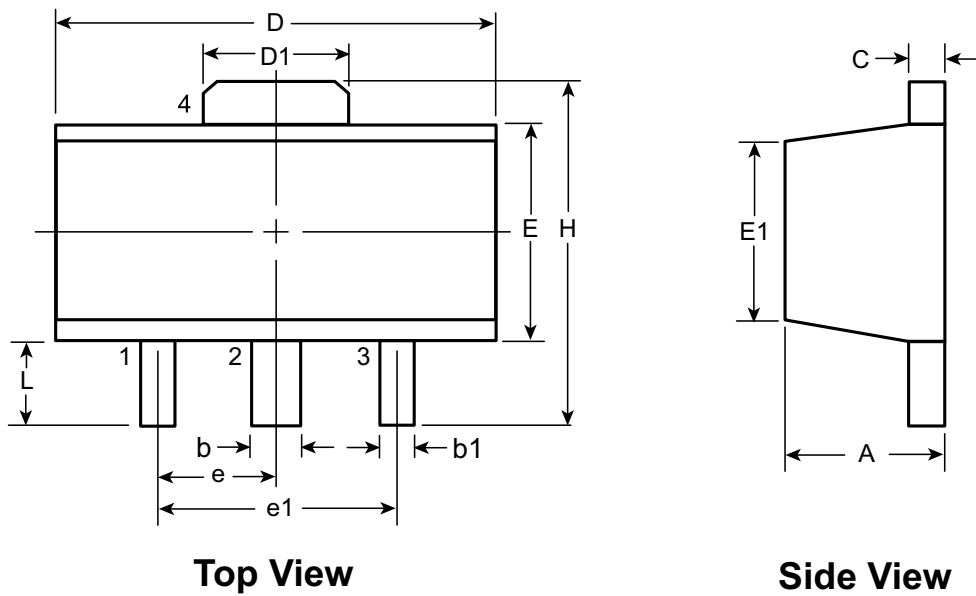

Top View

Side View

Symbol		A	b	b1	C	D	D1	E	E1	e	e1	H	L		
Dimensions (mm)	MIN	1.40	0.44	0.36	0.35	4.40	1.62	2.29	2.00†	1.50 BSC	3.00 BSC	3.94	0.73†		
	NOM	-	-	-	-	-	-	-	-			-	-	-	-
	MAX	1.60	0.56	0.48	0.44	4.60	1.83	2.60	2.29			4.25	1.20		

JEDEC Registration TO-243, Variation AA, Issue C, July 1986.

† This dimension differs from the JEDEC drawing

Drawings not to scale.

Supertex Doc. #: DSPD-3TO243AAN8, Version F111010.

(The package drawing(s) in this data sheet may not reflect the most current specifications. For the latest package outline information go to <http://www.supertex.com/packaging.html>.)

Supertex inc. does not recommend the use of its products in life support applications, and will not knowingly sell them for use in such applications unless it receives an adequate "product liability indemnification insurance agreement." Supertex inc. does not assume responsibility for use of devices described, and limits its liability to the replacement of the devices determined defective due to workmanship. No responsibility is assumed for possible omissions and inaccuracies. Circuitry and specifications are subject to change without notice. For the latest product specifications refer to the Supertex inc. (website: <http://www.supertex.com>)