

2-Mbit (128K x 16) Static RAM

Features

- **Temperature Ranges**
 - Industrial: -40°C to 85°C
 - Automotive-A: -40°C to 85°C
 - Automotive-E: -40°C to 125°C
- **High speed: 55 ns**
- **Wide voltage range: 2.7V–3.6V**
- **Ultra-low active, standby power**
- **Easy memory expansion with $\overline{\text{CE}}$ and $\overline{\text{OE}}$ features**
- **TTL-compatible inputs and outputs**
- **Automatic power-down when deselected**
- **CMOS for optimum speed/power**
- **Available in standard Pb-free 44-pin TSOP Type II, Pb-free and non Pb-free 48-ball FBGA packages**

Functional Description^[1]

The CY62136VN is a high-performance CMOS static RAM organized as 128K words by 16 bits. This device features advanced circuit design to provide ultra-low active current. This is ideal for providing More Battery Life™ (MoBL®) in

portable applications such as cellular telephones. The device also has an automatic power-down feature that significantly reduces power consumption by 99% when addresses are not toggling. The device can also be put into standby mode when deselected ($\overline{\text{CE}}$ HIGH). The input/output pins (I/O_0 through I/O_{15}) are placed in a high-impedance state when: deselected ($\overline{\text{CE}}$ HIGH), outputs are disabled ($\overline{\text{OE}}$ HIGH), $\overline{\text{BHE}}$ and $\overline{\text{BLE}}$ are disabled ($\overline{\text{BHE}}$, $\overline{\text{BLE}}$ HIGH), or during a write operation ($\overline{\text{CE}}$ LOW, and $\overline{\text{WE}}$ LOW).

Writing to the device is accomplished by taking Chip Enable ($\overline{\text{CE}}$) and Write Enable ($\overline{\text{WE}}$) inputs LOW. If Byte Low Enable ($\overline{\text{BLE}}$) is LOW, then data from I/O pins (I/O_0 through I/O_7), is written into the location specified on the address pins (A_0 through A_{16}). If Byte High Enable ($\overline{\text{BHE}}$) is LOW, then data from I/O pins (I/O_8 through I/O_{15}) is written into the location specified on the address pins (A_0 through A_{16}).

Reading from the device is accomplished by taking Chip Enable ($\overline{\text{CE}}$) and Output Enable ($\overline{\text{OE}}$) LOW while forcing the Write Enable ($\overline{\text{WE}}$) HIGH. If Byte Low Enable ($\overline{\text{BLE}}$) is LOW, then data from the memory location specified by the address pins will appear on I/O_0 to I/O_7 . If Byte High Enable ($\overline{\text{BHE}}$) is LOW, then data from memory will appear on I/O_8 to I/O_{15} . See the Truth Table at the back of this data sheet for a complete description of read and write modes.

Logic Block Diagram

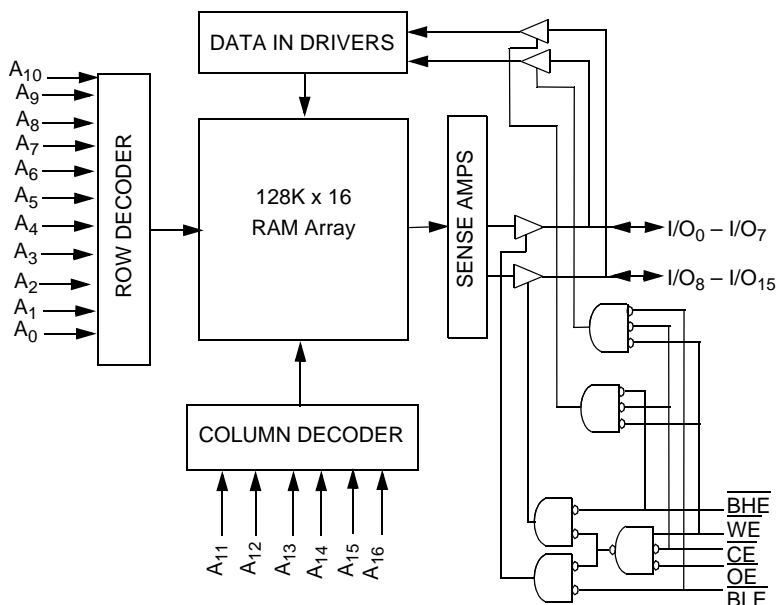

PinConfigurations^[3]

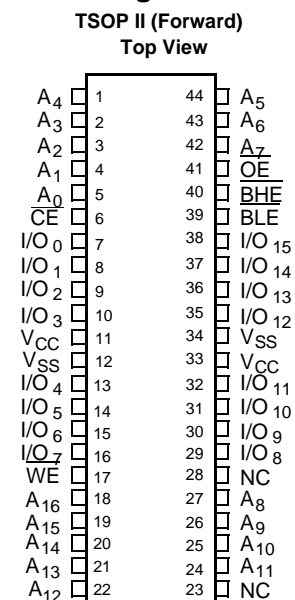

Note:

1. For best practice recommendations, please refer to the Cypress application note "System Design Guidelines" on <http://www.cypress.com>.

Product Portfolio

Product	V _{CC} Range (V)			Speed	Ranges	Power Dissipation			
	Min	Typ. ^[2]	Max			Operating, I _{CC} (mA)		Standby, I _{SB2} (μA)	
						Typ. ^[2]	Maximum	Typ. ^[2]	Maximum
CY62136VNLL	2.7	3.0	3.6	55	Industrial	7	20	1	15
				55	Automotive-A	7	20	1	15
				70	Industrial	7	15	1	15
				70	Automotive-A	7	15	1	15
				70	Automotive-E	7	20	1	20

Pin Configurations^[3]

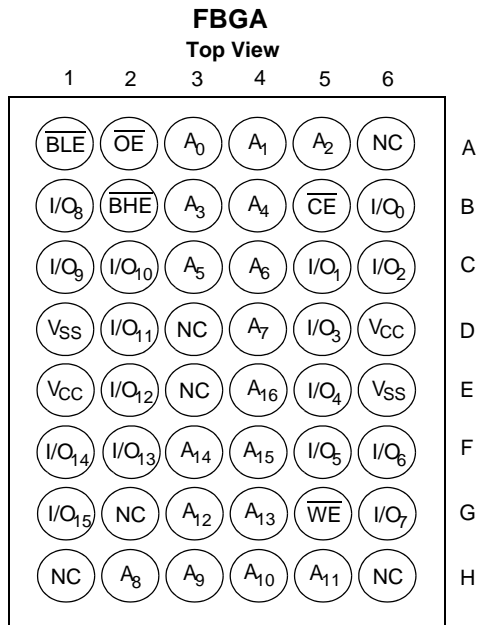

Notes:

2. Typical values are included for reference only and are not guaranteed or tested. Typical values are measured at V_{CC} = V_{CC} Typ, T_A = 25°C.
3. NC pins are not connected on the die.

Maximum Ratings

(Above which the useful life may be impaired. For user guidelines, not tested.)

Storage Temperature	-65°C to +150°C
Ambient Temperature with Power Applied.....	-55°C to +125°C
Supply Voltage to Ground Potential	-0.5V to +4.6V
DC Voltage Applied to Outputs in High-Z State ^[4]	-0.5V to $V_{CC} + 0.5V$
DC Input Voltage ^[4]	-0.5V to $V_{CC} + 0.5V$

Output Current into Outputs (LOW).....	20 mA
Static Discharge Voltage.....	> 2001V (per MIL-STD-883, Method 3015)
Latch-up Current.....	> 200 mA

Operating Range

Range	Ambient Temperature [T _A] ^[5]	V _{CC}
Industrial	-40°C to +85°C	2.7V to 3.6V
Automotive-A	-40°C to +85°C	
Automotive-E	-40°C to +125°C	

Electrical Characteristics Over the Operating Range

Parameter	Description	Test Conditions	-55			-70			Unit		
			Min.	Typ. ^[2]	Max.	Min.	Typ. ^[2]	Max.			
V _{OH}	Output HIGH Voltage	V _{CC} = 2.7V, I _{OH} = -1.0 mA	2.4			2.4			V		
V _{OL}	Output LOW Voltage	V _{CC} = 2.7V, I _{OL} = 2.1 mA			0.4			0.4	V		
V _{IH}	Input HIGH Voltage	V _{CC} = 3.6V	2.2		V _{CC} + 0.5V	2.2		V _{CC} + 0.5V	V		
V _{IL}	Input LOW Voltage	V _{CC} = 2.7V	-0.5		0.8	-0.5		0.8	V		
I _{IX}	Input Leakage Current	GND ≤ V _I ≤ V _{CC}	Ind'l	-1		+1	-1		+1	μA	
			Auto-A	-1		+1	-1		+1	μA	
			Auto-E				-10		+10	μA	
I _{OZ}	Output Leakage Current	GND ≤ V _O ≤ V _{CC} , Output Disabled	Ind'l	-1		+1	-1		+1	μA	
			Auto-A	-1		+1	-1		+1	μA	
			Auto-E				-10		+10	μA	
I _{CC}	V _{CC} Operating Supply Current	f = f _{MAX} = 1/t _{RC}	V _{CC} = 3.6V, I _{OUT} = 0 mA, CMOS Levels	Ind'l		7	20		7	15	mA
				Auto-A		7	20		7	15	
				Auto-E					7	20	
		f = 1 MHz	Ind'l		1	2		1	2	mA	
			Auto-A		1	2		1	2		
			Auto-E					1	2		
I _{SB1}	Automatic CE Power-down Current—CMOS Inputs	CE ≥ V _{CC} - 0.3V, V _{IN} ≥ V _{CC} - 0.3V or V _{IN} ≤ 0.3V, f = f _{MAX}	Ind'l			100			100	μA	
			Auto-A			100			100	μA	
			Auto-E						100	μA	
I _{SB2}	Automatic CE Power-down Current—CMOS Inputs	CE ≥ V _{CC} - 0.3V, V _{IN} ≥ V _{CC} - 0.3V or V _{IN} ≤ 0.3V, f = 0	Ind'l		1	15		1	15	μA	
			Auto-A		1	15		1	15		
			Auto-E					1	20		

Capacitance^[6]

Parameter	Description	Test Conditions	Max.	Unit
C _{IN}	Input Capacitance	T _A = 25°C, f = 1 MHz, V _{CC} = V _{CC(typ)}	6	pF
C _{OUT}	Output Capacitance		8	pF

Notes:

- V_{IL(min)} = -2.0V for pulse durations less than 20 ns.
- T_A is the "Instant-On" case temperature.
- Tested initially and after any design or process changes that may affect these parameters.

Thermal Resistance^[6]

Parameter	Description	Test Conditions	TSOPII	FBGA	Unit
Θ_{JA}	Thermal Resistance (Junction to Ambient)	Still Air, soldered on a 4.25 x 1.125 inch, 4-layer printed circuit board	60	55	°C/W
Θ_{JC}	Thermal Resistance (Junction to Case)		22	16	°C/W

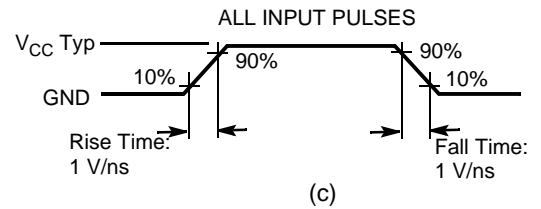
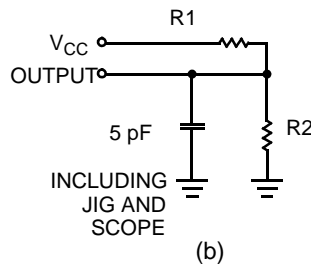
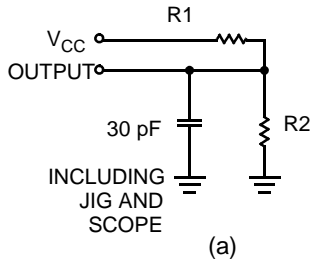
AC Test Loads and Waveforms

Equivalent to: THÉVENIN EQUIVALENT



Parameters	Value	Unit
R1	1105	Ohms
R2	1550	Ohms
R_{TH}	645	Ohms
V_{TH}	1.75	Volts

Data Retention Characteristics (Over the Operating Range)

Parameter	Description	Conditions ^[9]	Min.	Typ. ^[2]	Max.	Unit
V_{DR}	V_{CC} for Data Retention		1.0			V
I_{CCDR}	Data Retention Current	$V_{CC} = 1.0V, \overline{CE} \geq V_{CC} - 0.3V,$ $V_{IN} \geq V_{CC} - 0.3V$ or $V_{IN} \leq 0.3V,$		0.5	7.5	μA
$t_{CDR}^{[6]}$	Chip Deselect to Data Retention Time		0			ns
$t_R^{[7]}$	Operation Recovery Time		70			ns

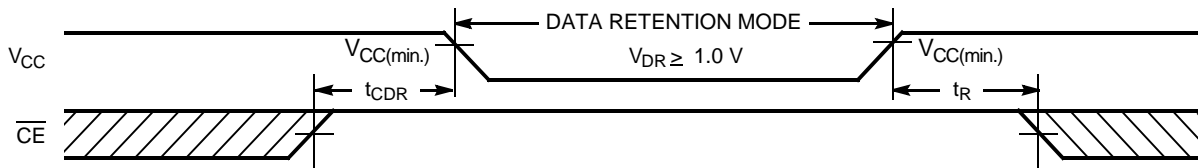
Data Retention Waveform

Note:

7. Full device operation requires linear V_{CC} ramp from V_{DR} to $V_{CC(min)}$ ≥ 100 ms or stable at $V_{CC(min)}$ ≥ 100 ms.
8. No input may exceed $V_{CC} + 0.3V$

Switching Characteristics Over the Operating Range ^[9]

Parameter	Description	55 ns		70 ns		Unit
		Min.	Max.	Min.	Max.	
Read Cycle						
t _{RC}	Read Cycle Time	55		70		ns
t _{AA}	Address to Data Valid		55		70	ns
t _{OHA}	Data Hold from Address Change	10		10		ns
t _{ACE}	\overline{CE} LOW to Data Valid		55		70	ns
t _{DOE}	\overline{OE} LOW to Data Valid		25		35	ns
t _{LZOE}	\overline{OE} LOW to Low-Z ^[10]	5		5		ns
t _{HZOE}	\overline{OE} HIGH to High-Z ^[10, 11]		25		25	ns
t _{LZCE}	\overline{CE} LOW to Low-Z ^[10]	10		10		ns
t _{HZCE}	\overline{CE} HIGH to High-Z ^[10, 11]		25		25	ns
t _{PU}	\overline{CE} LOW to Power-up	0		0		ns
t _{PD}	\overline{CE} HIGH to Power-down		55		70	ns
t _{DBE}	$\overline{BLE} / \overline{BHE}$ LOW to Data Valid		25		35	ns
t _{LZBE}	$\overline{BLE} / \overline{BHE}$ LOW to Low-Z ^[10, 11]	5		5		ns
t _{HZBE}	$\overline{BLE} / \overline{BHE}$ HIGH to High-Z ^[12]		25		25	ns
Write Cycle^[12, 13]						
t _{WC}	Write Cycle Time	55		70		ns
t _{SCE}	\overline{CE} LOW to Write End	45		60		ns
t _{AW}	Address Set-up to Write End	45		60		ns
t _{HA}	Address Hold from Write End	0		0		ns
t _{SA}	Address Set-up to Write Start	0		0		ns
t _{PWE}	\overline{WE} Pulse Width	40		50		ns
t _{BW}	$\overline{BLE} / \overline{BHE}$ LOW to Write End	50		60		ns
t _{SD}	Data Set-up to Write End	25		30		ns
t _{HD}	Data Hold from Write End	0		0		ns
t _{HZWE}	\overline{WE} LOW to High-Z ^[10, 11]		20		25	ns
t _{LZWE}	\overline{WE} HIGH to Low-Z ^[10]	5		10		ns

Notes:

9. Test conditions assume signal transition time of 5 ns or less, timing reference levels of 1.5V, input pulse levels of 0 to V_{CC} typ., and output loading of the specified I_{OL}/I_{OH} and 30-pF load capacitance.
10. At any given temperature and voltage condition, t_{HZCE} is less than t_{LZCE}, t_{HZOE} is less than t_{LZOE}, and t_{HZWE} is less than t_{LZWE} for any given device.
11. t_{HZOE}, t_{HZCE}, and t_{HZWE} are specified with C_L = 5 pF as in (b) of AC Test Loads. Transition is measured ±500 mV from steady-state voltage.
12. The internal write time of the memory is defined by the overlap of \overline{CE} LOW and \overline{WE} LOW. Both signals must be LOW to initiate a write and either signal can terminate a write by going HIGH. The data input set-up and hold timing should be referenced to the rising edge of the signal that terminates the write.
13. The minimum write cycle time for write cycle 3 (\overline{WE} controlled, \overline{OE} LOW) is the sum of t_{HZWE} and t_{SD}.

Switching Waveforms

Read Cycle No. 1^[14, 15]

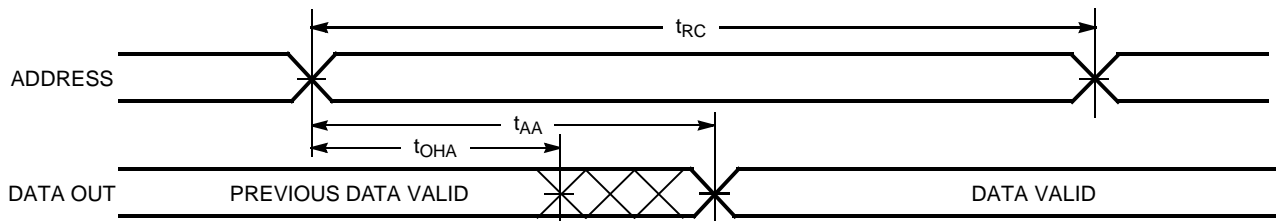

Read Cycle No. 2^[15, 16]

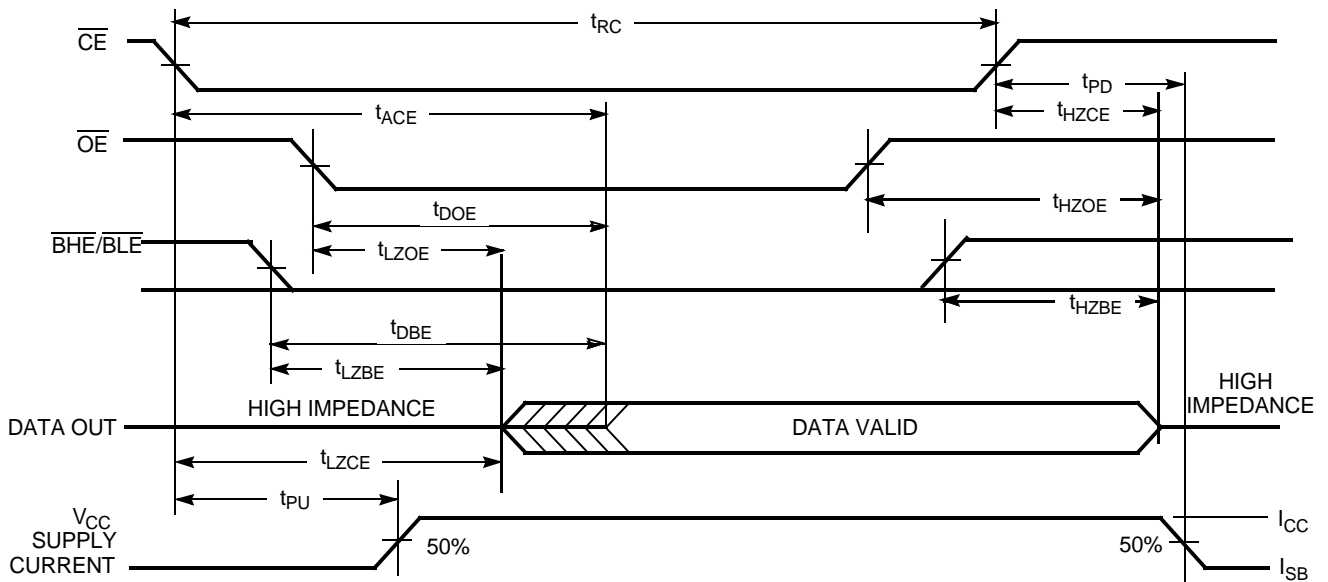

Notes:

- 14. Device is continuously selected. $\overline{OE}, \overline{CE} = V_{IL}$.
- 15. \overline{WE} is HIGH for read cycle.
- 16. Address valid prior to or coincident with \overline{CE} transition LOW.

Switching Waveforms (continued)

Write Cycle No. 1 ($\overline{\text{WE}}$ Controlled)^[12, 17, 18]

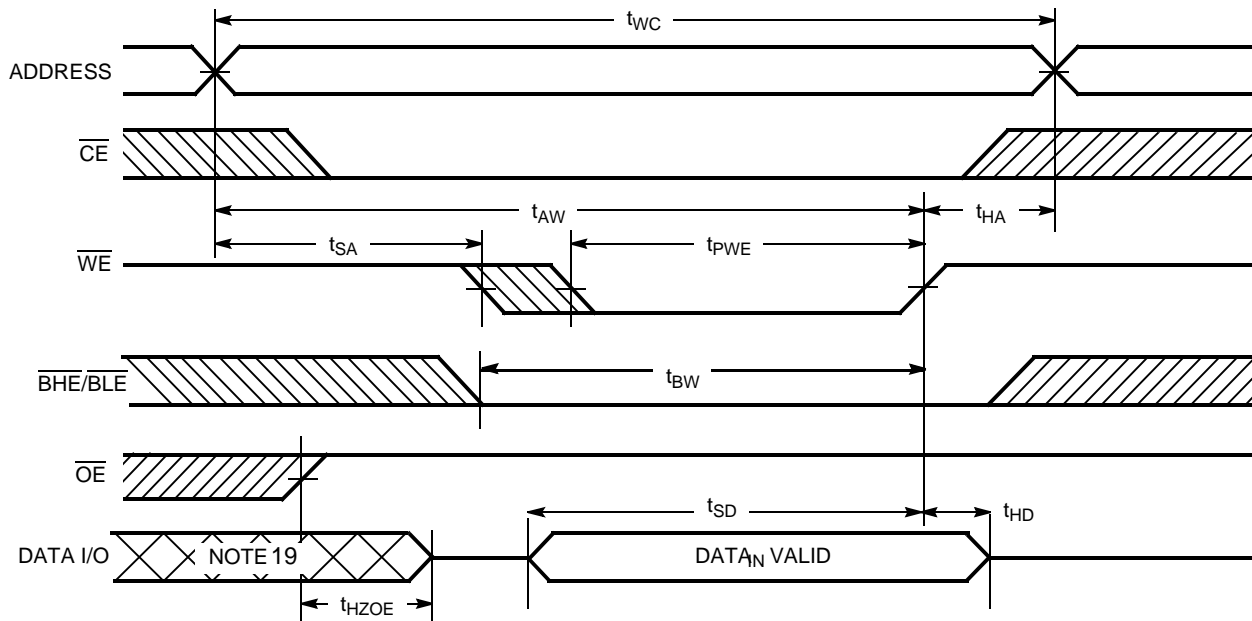

Write Cycle No. 2 ($\overline{\text{CE}}$ Controlled)^[12, 17, 18]

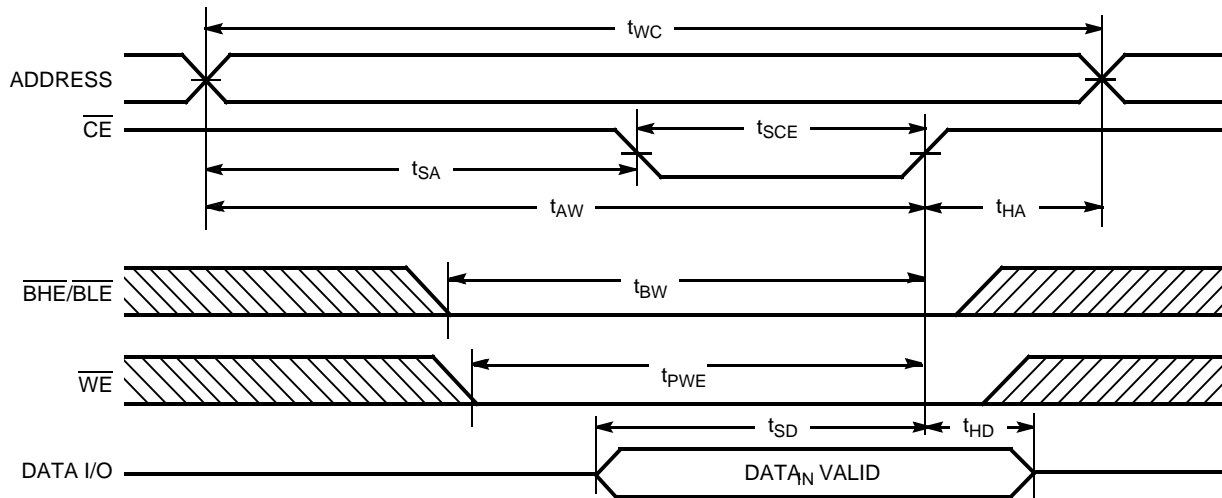

Notes:

- 17. Data I/O is high impedance if $\overline{\text{OE}} = V_{IH}$.
- 18. If $\overline{\text{CE}}$ goes HIGH simultaneously with $\overline{\text{WE}}$ HIGH, the output remains in a high-impedance state.
- 19. During this period, the I/Os are in output state and input signals should not be applied.

Switching Waveforms (continued)

Write Cycle No. 3 ($\overline{\text{WE}}$ Controlled, $\overline{\text{OE}}$ LOW)^[13, 18]

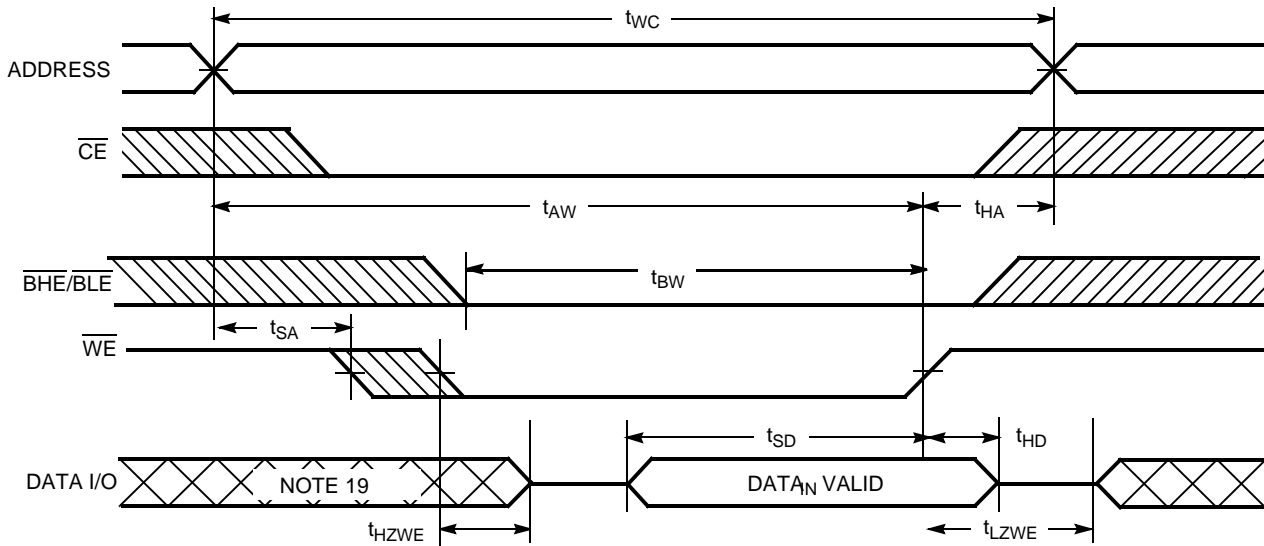

Write Cycle No. 4 ($\overline{\text{BHE/BLE}}$ Controlled, $\overline{\text{OE}}$ LOW)^[19]

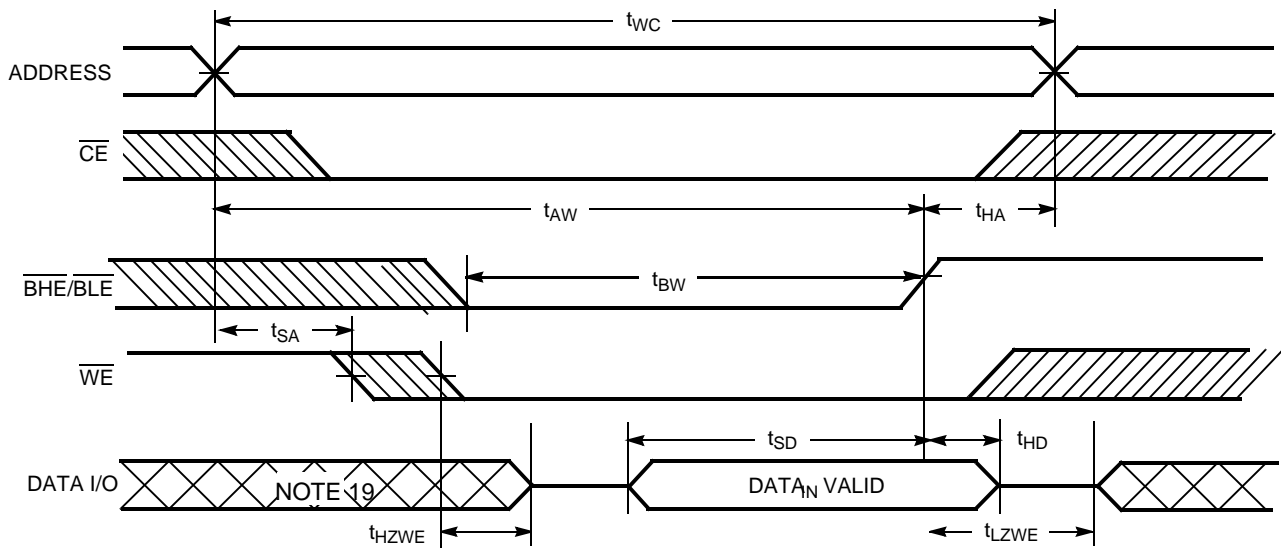

Typical DC and AC Characteristics

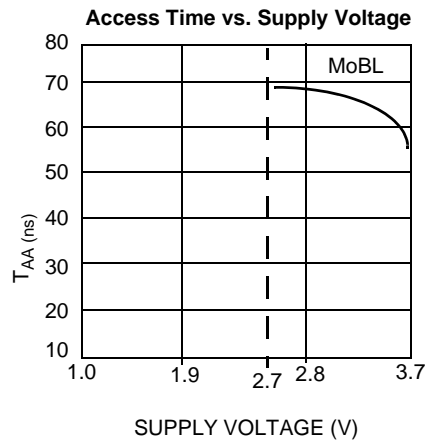
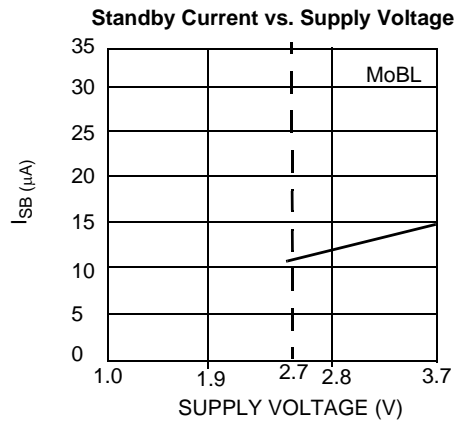
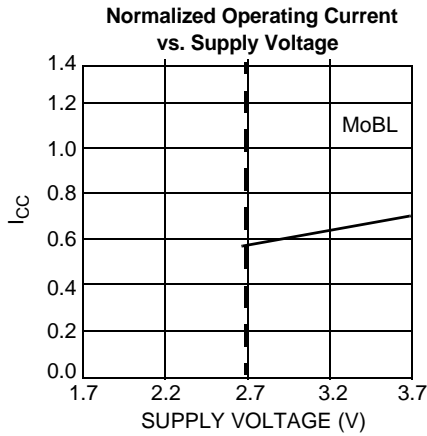

Truth Table

\overline{CE}	\overline{WE}	\overline{OE}	\overline{BHE}	\overline{BLE}	Inputs/Outputs	Mode	Power
H	X	X	X	X	High-Z	Deselect/Power-down	Standby (I_{SB})
L	H	L	L	L	Data Out (I/O_0 – I/O_{15})	Read	Active (I_{CC})
L	H	L	H	L	Data Out (I/O_0 – I/O_7); I/O_8 – I/O_{15} in High-Z	Read	Active (I_{CC})
L	H	L	L	H	Data Out (I/O_8 – I/O_{15}); I/O_0 – I/O_7 in High-Z	Read	Active (I_{CC})
L	H	L	H	H	High-Z	Deselect/Output Disabled	Active (I_{CC})
L	H	H	L	L	High-Z	Deselect/Output Disabled	Active (I_{CC})
L	H	H	H	L	High-Z	Deselect/Output Disabled	Active (I_{CC})
L	H	H	L	H	High-Z	Deselect/Output Disabled	Active (I_{CC})
L	L	X	L	L	Data In (I/O_0 – I/O_{15})	Write	Active (I_{CC})
L	L	X	H	L	Data In (I/O_0 – I/O_7); I/O_8 – I/O_{15} in High-Z	Write	Active (I_{CC})
L	L	X	L	H	Data In (I/O_8 – I/O_{15}); I/O_0 – I/O_7 in High-Z	Write	Active (I_{CC})

Ordering Information

Speed (ns)	Ordering Code	Package Diagram	Package Type	Operating Range
55	CY62136VNLL-55ZXI	51-85087	44-pin TSOP II (Pb-Free)	Industrial
	CY62136VNLL-55BAI	51-85096	48-Ball (7.00 mm x 7.00 mm) FBGA	
	CY62136VNLL-55ZSXA	51-85087	44-pin TSOP II (Pb-Free)	Automotive-A
70	CY62136VNLL-70ZXI	51-85087	44-pin TSOP II (Pb-Free)	Industrial
	CY62136VNLL-70BAI	51-85096	48-Ball (7.00 mm x 7.00 mm) FBGA	Automotive-A
	CY62136VNLL-70BAXA	51-85096	48-Ball (7.00 mm x 7.00 mm) FBGA (Pb-Free)	
	CY62136VNLL-70ZSXA	51-85087	44-pin TSOP II (Pb-Free)	
	CY62136VNLL-70ZSXE	51-85087	44-pin TSOP II (Pb-Free)	Automotive-E

Please contact your local Cypress sales representative for availability of these parts

Package Diagrams

44-pin TSOP II (51-85087)

DIMENSION IN MM (INCH)
MAX
MIN

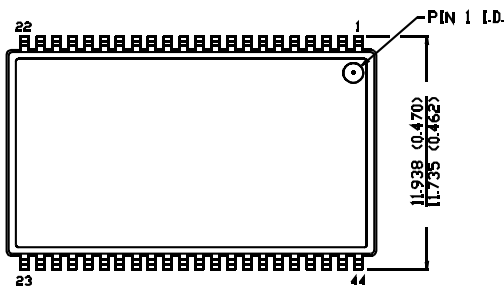

TOP VIEW

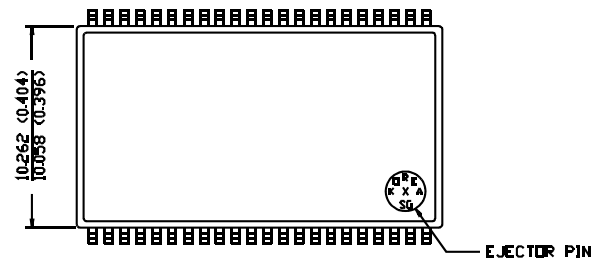

BOTTOM VIEW

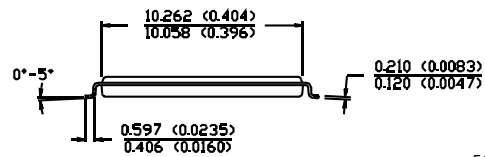
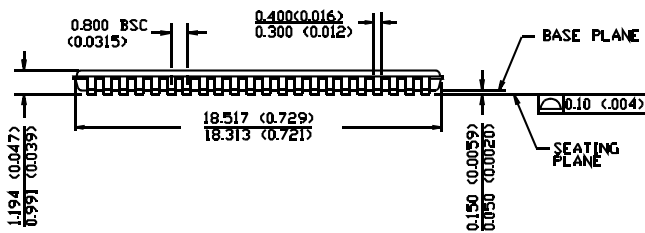

51-85087-*A

Package Diagrams (continued)

48-Ball (7.00 mm x 7.00 mm) FBGA (51-85096)

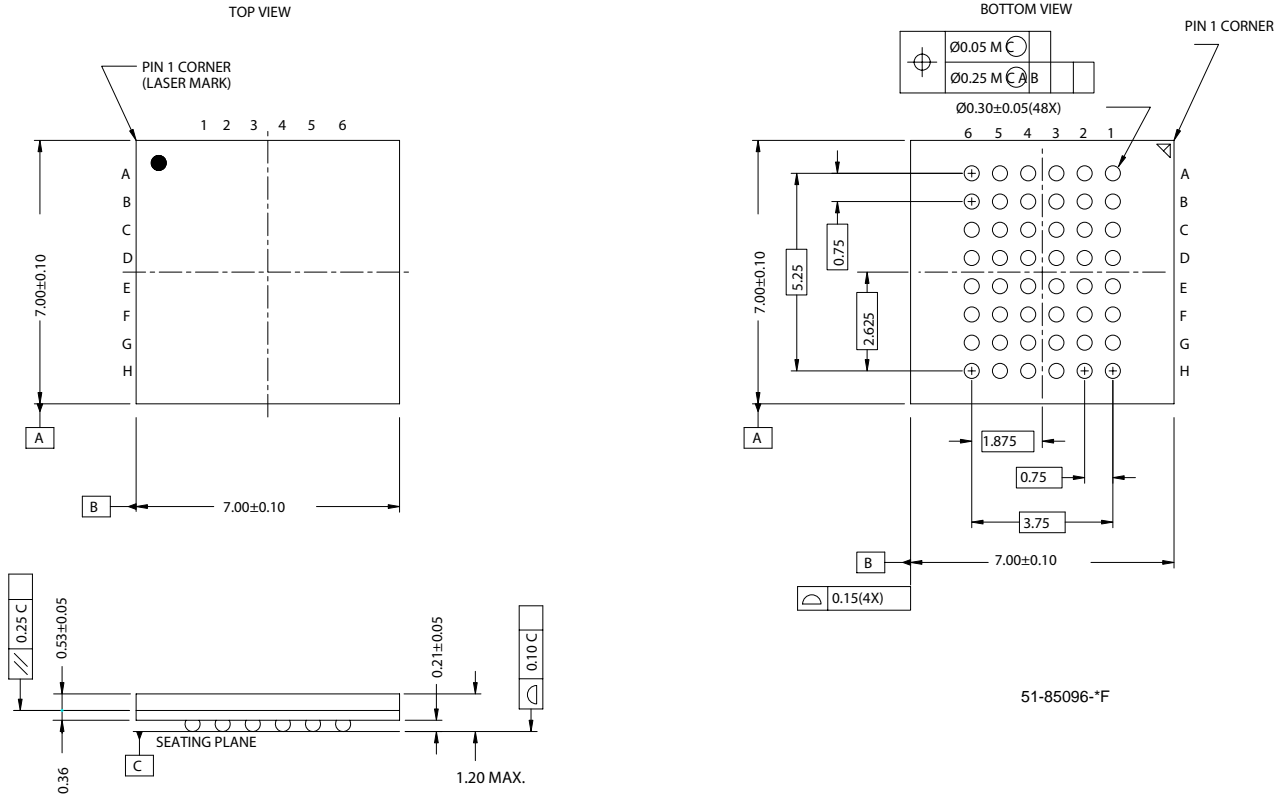

MoBL is a registered trademark, and More Battery Life is a trademark, of Cypress Semiconductor Corporation. All product and company names mentioned in this document are the products of their respective holders.

Document History Page

Document Title: CY62136VN MoBL[®] 2-Mbit (128K x 16) Static RAM Document Number: 001-06510				
REV.	ECN NO.	Issue Date	Orig. of Change	Description of Change
**	426503	See ECN	R XU	New Data Sheet
*A	488954	See ECN	NXR	Added Automotive product Updated ordering Information table