

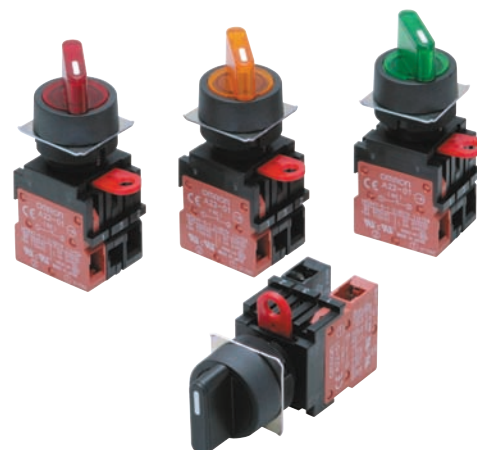

Install in 22-dia. or 25-dia. Panel Cutout

- Lever for easily mounting and removing the Switch Unit
- Finger protection mechanism on Switch Unit provided as a standard feature.
- Use 25-dia. ring to install in 25-dia. panel cutouts.
- Mounted using either open-type (fork-type) or closed-type (round-type) crimp terminals.
- IP65 oil resistance (non-lighted models)
IP65 (lighted models)



Note: Orders for non-lighted (IP65 oil-resistant) and lighted Selectors (completely assembled/subassembled) listed in this catalog will not be accepted after March 31, 2018.

 Refer to *Safety Precautions for All Pushbutton Switches/Indicators* and *Safety Precautions* for the A22.

Model Number Structure

Model Number Legend Shipped as a set which includes the Selector, Lamp (lighted models only), and Switch.
For information on combinations, refer to *Ordering Information* on pages 2 to 4.

(1) (2) (3) (4) (5)
A 22 W - 2M G - 6A - 11

(1) Lighted/Non-lighted

Code	Description
S	Non-lighted
W	Lighted

(3) Illumination Color

Code	Color
R	Red
G	Green
Y	Yellow
A	Blue
None	Black*

* For non-lighted models only

(4) Light Source Without Voltage Reduction Unit

Code	Type	Operating Voltage
None	Non-lighted	
6A	LED	6 VAC/VDC
12A		12 VAC/VDC
24A		24 VAC/VDC
5	Incandescent lamp	5 VAC/VDC
12		12 VAC/VDC
24		24 VAC/VDC

With Voltage Reduction Unit

Code	Type	Operating Voltage
T1	LED	100 VAC
T2		200 VAC

• LED incorporates the 24-VAC/VDC models.

(5) Contacts

Code	Description
10	SPST-NO *
01	SPST-NC *
11	SPST-NO + SPST-NC
20	SPST-NO + SPST-NO
02	SPST-NC + SPST-NC

* For models with 2 notches
Note: The contacts are rated for standard loads. For microloads, refer to Accessories section for the A22.

(2) Number of Notches/Reset Method

Code	Number of Notches	Reset Method
2M	2 notches	Manual
2A		Automatic
3M	3 notches	Manual
3A		Automatic

Ordering Information

Completely Assembled Shipped as a set which includes the Selector, Lamp (lighted models only), and Switch.

Non-lighted Knob-type Selector Switch (Orders will not be accepted after March 31, 2018.)

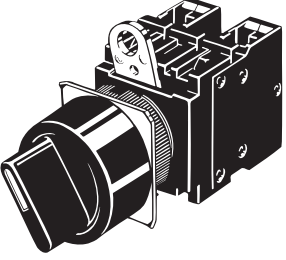
Appearance	Number of notches	Resetting method	Output	Model	Color of Selector
Knob-type Selector Switch A22S 	2 notches	Manual	SPST-NO	A22S-2M-10	Black
			SPST-NC	A22S-2M-01	
			SPST-NO + SPST-NC	A22S-2M-11	
			SPST-NO + SPST-NO	A22S-2M-20	
		SPST-NC + SPST-NC	A22S-2M-02		
		Automatic	SPST-NO	A22S-2A-10	
			SPST-NC	A22S-2A-01	
			SPST-NO + SPST-NC	A22S-2A-11	
	SPST-NO + SPST-NO		A22S-2A-20		
	3 notches	Manual	SPST-NC + SPST-NC	A22S-2A-02	
			SPST-NO + SPST-NC	A22S-3M-11	
			SPST-NO + SPST-NO	A22S-3M-20	
		Automatic	SPST-NC + SPST-NC	A22S-3M-02	
			SPST-NO + SPST-NC	A22S-3A-11	
			SPST-NO + SPST-NO	A22S-3A-20	
SPST-NC + SPST-NC			A22S-3A-02		

Note: The contact ratings are for standard loads.

Ordering Information

Completely Assembled Shipped as a set which includes the Selector, Lamp (lighted models only), and Switch.
Lighted Knob-type Selector Switch (Orders will not be accepted after March 31, 2018.)

Appearance	Number of notches	Resetting method	Output	Operating voltage	Model	Illumination color
Knob-type Selector Switch A22W LED lighting (without Voltage Reduction Unit)	2 notches	Manual	SPST-NO	6 VAC/VDC	A22W-2M□-6A-10	R (red) Y (yellow) G (green) A (blue)
				12 VAC/VDC	A22W-2M□-12A-10	
				24 VAC/VDC	A22W-2M□-24A-10	
			SPST-NC	6 VAC/VDC	A22W-2M□-6A-01	
				12 VAC/VDC	A22W-2M□-12A-01	
				24 VAC/VDC	A22W-2M□-24A-01	
			SPST-NO + SPST-NC	6 VAC/VDC	A22W-2M□-6A-11	
				12 VAC/VDC	A22W-2M□-12A-11	
				24 VAC/VDC	A22W-2M□-24A-11	
		SPST-NO + SPST-NO	6 VAC/VDC	A22W-2M□-6A-20		
			12 VAC/VDC	A22W-2M□-12A-20		
			24 VAC/VDC	A22W-2M□-24A-20		
		SPST-NC + SPST-NC	6 VAC/VDC	A22W-2M□-6A-02		
			12 VAC/VDC	A22W-2M□-12A-02		
			24 VAC/VDC	A22W-2M□-24A-02		
		Automatic	SPST-NO	6 VAC/VDC	A22W-2A□-6A-10	
				12 VAC/VDC	A22W-2A□-12A-10	
				24 VAC/VDC	A22W-2A□-24A-10	
	SPST-NC		6 VAC/VDC	A22W-2A□-6A-01		
			12 VAC/VDC	A22W-2A□-12A-01		
			24 VAC/VDC	A22W-2A□-24A-01		
	SPST-NO + SPST-NC		6 VAC/VDC	A22W-2A□-6A-11		
			12 VAC/VDC	A22W-2A□-12A-11		
			24 VAC/VDC	A22W-2A□-24A-11		
	SPST-NO + SPST-NO		6 VAC/VDC	A22W-2A□-6A-20		
			12 VAC/VDC	A22W-2A□-12A-20		
			24 VAC/VDC	A22W-2A□-24A-20		
	SPST-NC + SPST-NC	6 VAC/VDC	A22W-2A□-6A-02			
		12 VAC/VDC	A22W-2A□-12A-02			
		24 VAC/VDC	A22W-2A□-24A-02			
3 notches	Manual	SPST-NO + SPST-NC	6 VAC/VDC	A22W-3M□-6A-11		
			12 VAC/VDC	A22W-3M□-12A-11		
			24 VAC/VDC	A22W-3M□-24A-11		
		SPST-NO + SPST-NO	6 VAC/VDC	A22W-3M□-6A-20		
			12 VAC/VDC	A22W-3M□-12A-20		
			24 VAC/VDC	A22W-3M□-24A-20		
	SPST-NC + SPST-NC	6 VAC/VDC	A22W-3M□-6A-02			
		12 VAC/VDC	A22W-3M□-12A-02			
		24 VAC/VDC	A22W-3M□-24A-02			
	Automatic	SPST-NO + SPST-NC	6 VAC/VDC	A22W-3A□-6A-11		
			12 VAC/VDC	A22W-3A□-12A-11		
			24 VAC/VDC	A22W-3A□-24A-11		
SPST-NO + SPST-NO		6 VAC/VDC	A22W-3A□-6A-20			
		12 VAC/VDC	A22W-3A□-12A-20			
		24 VAC/VDC	A22W-3A□-24A-20			
SPST-NC + SPST-NC	6 VAC/VDC	A22W-3A□-6A-02				
	12 VAC/VDC	A22W-3A□-12A-02				
	24 VAC/VDC	A22W-3A□-24A-02				

Note: 1. When ordering, specify the symbol that indicates color of the Selector in the □ of the model number.
 2. The contact ratings are for standard loads.

Individual models: Refer to pages 6 to 7.
 (The Selector, Lamp, and Switch can be ordered separately.)

■ Specifications: Refer to the A22. ■ Dimensions: Refer to page 10.
 ■ Accessories and tools: Refer to the A22.

Ordering Information

Completely Assembled Shipped as a set which includes the Selector, Lamp (lighted models only), and Switch.
Lighted Knob-type Selector Switch (Orders will not be accepted after March 31, 2018.)

Appearance	Number of notches	Resetting method	Output	Operating voltage	Model	Selector symbol (color)
Knob-type Selector Switch A22W LED voltage-reduction lighting (with Voltage Reduction Unit)	2 notches	Manual	SPST-NO	100 VAC	A22W-2M□-T1-10	R (red) Y (yellow) G (green) A (blue)
				200 VAC	A22W-2M□-T2-10	
			SPST-NC	100 VAC	A22W-2M□-T1-01	
				200 VAC	A22W-2M□-T2-01	
			SPST-NO + SPST-NC	100 VAC	A22W-2M□-T1-11	
				200 VAC	A22W-2M□-T2-11	
		SPST-NO + SPST-NO	100 VAC	A22W-2M□-T1-20		
			200 VAC	A22W-2M□-T2-20		
		Automatic	SPST-NC + SPST-NC	100 VAC	A22W-2M□-T1-02	
				200 VAC	A22W-2M□-T2-02	
			SPST-NO	100 VAC	A22W-2A□-T1-10	
				200 VAC	A22W-2A□-T2-10	
	SPST-NC		100 VAC	A22W-2A□-T1-01		
			200 VAC	A22W-2A□-T2-01		
	SPST-NO + SPST-NC	100 VAC	A22W-2A□-T1-11			
		200 VAC	A22W-2A□-T2-11			
	3 notches	Manual	SPST-NO + SPST-NC	100 VAC	A22W-3M□-T1-11	
				200 VAC	A22W-3M□-T2-11	
			SPST-NO + SPST-NO	100 VAC	A22W-3M□-T1-20	
				200 VAC	A22W-3M□-T2-20	
		SPST-NC + SPST-NC	100 VAC	A22W-3M□-T1-02		
			200 VAC	A22W-3M□-T2-02		
	Automatic	SPST-NO + SPST-NC	100 VAC	A22W-3A□-T1-11		
			200 VAC	A22W-3A□-T2-11		
SPST-NO + SPST-NO		100 VAC	A22W-3A□-T1-20			
		200 VAC	A22W-3A□-T2-20			
SPST-NC + SPST-NC	100 VAC	A22W-3A□-T1-02				
	200 VAC	A22W-3A□-T2-02				

Note: 1. When ordering, specify the symbol that indicates color of the Selector in the □ of the model number.
 2. The contact ratings are for standard loads.

Individual models: Refer to pages 6 to 7.
 (The Selector, Lamp, and Switch can be ordered separately.)

■ Specifications: Refer to the A22. ■ Dimensions: Refer to page 10.
 ■ Accessories and tools: Refer to the A22.

Ordering Information

Completely Assembled..... The Selector, Lamp, or Switch can be ordered separately. Use them in combination for models that are not available as assembled Units. These can also be used as inventory for maintenance parts.

Ordering: Specify the model from the listing starting on page 6.

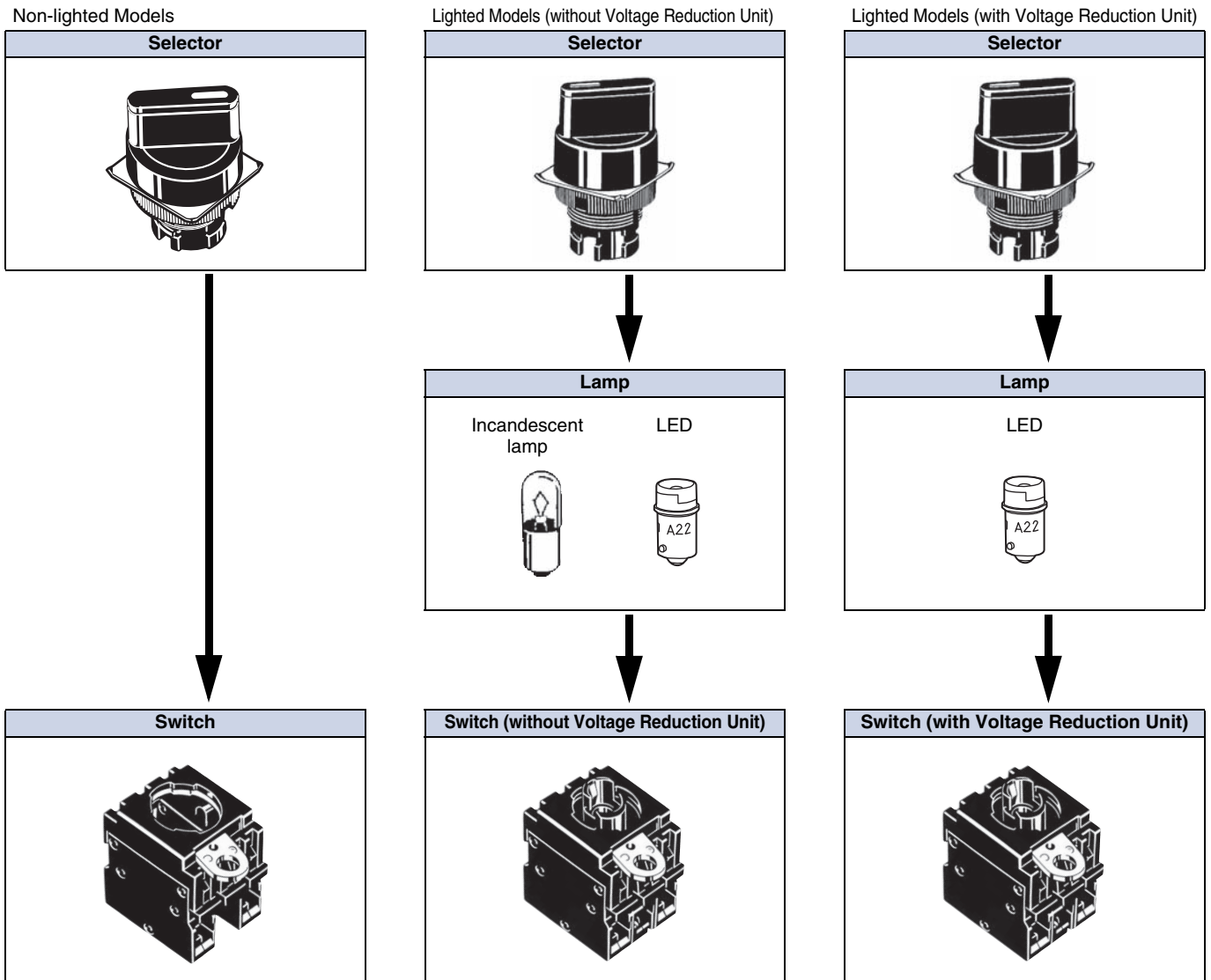

Set models: Refer to pages 2 to 4.





■ Specifications: Refer to the A22. ■ Dimensions: Refer to page 10.
 ■ Accessories and tools: Refer to the A22.

Ordering Information



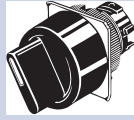

Subassembled..... The Selector, Lamp, or Switch can be ordered separately. Use them in combination for models that are not available as assembled Units. These can also be used as inventory for maintenance parts.

Selectors





Non-lighted (Color: Only Black is Available)

Sealing		IP65 (oil-resistant)	
Appearance		Standard lever	
Notches	Reset method	Model	
2 notches	Manual 	A22S-2M *	
	Automatic 	A22S-2A *	
3 notches	Manual 	A22S-3M *	
	Automatic 	A22S-3A *	

* Orders will not be accepted after March 31, 2018.

Sealing		IP65 (oil-resistant)	
Appearance		Long lever	
Notches	Reset method	Model	
2 notches	Manual 	A22S-C2M	
	Automatic 	A22S-C2A	
3 notches	Manual 	A22S-C3M	
	Automatic 	A22S-C3A	

Lighted (Orders will not be accepted after March 31, 2018.)

Sealing			IP65	
Appearance			Standard lever	
Notches	Reset method	Selector color	Model	
2 notches	Manual 	Red	A22W-2MR	
		Green	A22W-2MG	
		Yellow	A22W-2MY	
	Automatic 	Blue	A22W-2MA	
		Red	A22W-2AR	
		Green	A22W-2AG	
3 notches	Manual 	Yellow	A22W-2AY	
		Blue	A22W-2AA	
		Red	A22W-3MR	
	Automatic 	Green	A22W-3MG	
		Yellow	A22W-3MY	
		Blue	A22W-3MA	
		Red	A22W-3AR	
		Green	A22W-3AG	
		Yellow	A22W-3AY	
	Blue	A22W-3AA		

Note: Either incandescent lamps or LED lamps can be used with the above models.

Set models: Refer to pages 2 to 4.

■ Specifications: Refer to the A22. ■ Dimensions: Refer to page 10.
 ■ Accessories and tools: Refer to the A22.

Ordering Information

Subassembled..... The Selector, Lamp, or Switch can be ordered separately. Use them in combination for models that are not available as assembled Units. These can also be used as inventory for maintenance parts.

Switches (Standard Load)

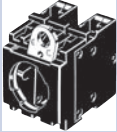
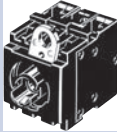
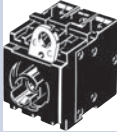
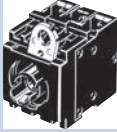
Appearance	Non-lighted	Lighted		
		Without Voltage Reduction Unit 	With Voltage Reduction Unit 110 VAC 	With Voltage Reduction Unit 220 VAC 
Contacts	Model			
SPST-NO	A22-10M	A22L-10M	A22L-10M-T1	A22L-10M-T2
SPST-NC	A22-01M	A22L-01M	A22L-01M-T1	A22L-01M-T2
SPST-NO + SPST-NC	A22-11M	A22L-11M	A22L-11M-T1	A22L-11M-T2
SPST-NO + SPST-NO	A22-20M	A22L-20M	A22L-20M-T1	A22L-20M-T2
SPST-NC + SPST-NC	A22-02M	A22L-02M	A22L-02M-T1	A22L-02M-T2

Note: For voltage-reduction lighting, use the A22-24A □. Only 24-V LED lamps can be used.

Lamps

LED Lamp

Operating voltage		6 VAC/VDC	12 VAC/VDC	24 VAC/VDC
Appearance	LED light	Model		
		AC and DC		
Red		A22-6AR	A22-12AR	A22-24AR
Green		A22-6AG	A22-12AG	A22-24AG
Yellow*		A22-6AY	A22-12AY	A22-24AY
	Blue	A22-6AA	A22-12AA	A22-24AA

Note: For voltage-reduction lighting, use the A22-24A □. Only 24-V LED lamps can be used.

* Used when the Selector color is yellow or white.

Incandescent Lamp

Appearance	Operating voltage	5 VAC/VDC	12 VAC/VDC	24 VAC/VDC
		A22-5	A22-12	A22-24

Set models: Refer to pages 2 to 4.

■ Specifications: Refer to the A22. ■ Dimensions: Refer to page 10.
■ Accessories and tools: Refer to the A22.

Nomenclature

Model Structure

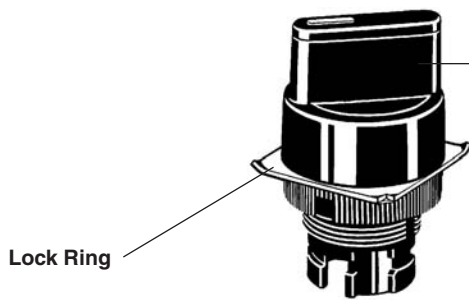

Selector

- **Number of Notches**
2 notches/3 notches
- **Applicable Colors**
Non-lighted: Black
Lighted: Red, Green Yellow, Blue



Lamp

- **Light Source**
LED lamp
Incandescent lamp

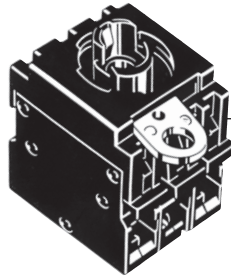

Switch

- **Contacts**
SPST-NO, SPST-NC, SPST-NO + SPST-NC,
SPST-NO + SPST-NO, SPST-NC + SPST-NC
(Minimum applicable load: 10 mA at 5 VDC)
- **Lighting Method**
Non-lighted
Lighted (without Voltage Reduction Unit)
Lighted (with Voltage Reduction Unit)

■ Specifications: Refer to the A22.
■ Dimensions: Refer to page 10.

■ Precautions for correct use: Refer to the A22.
■ Accessories and tools: Refer to the A22.

Nomenclature

Contacts

2-notch Type

Knob position	SPST-NO	SPST-NC	SPST-NO + SPST-NC	SPST-NO + SPST-NO	SPST-NC + SPST-NC

3-notch Type

Knob position	SPST-NO + SPST-NC	SPST-NO + SPST-NO	SPST-NC + SPST-NC

Operation Angle

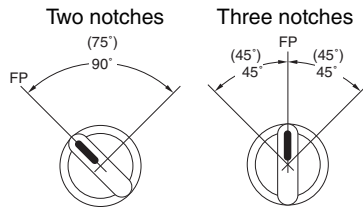

- Note: 1. The angle used for automatic reset is shown in parentheses.
 2. FP: Free Position

Dimensions

Knob-type Selector Switch (Lighted/Non-lighted)

Knob-type Selector Switch

A22S/A22W

A22S-C

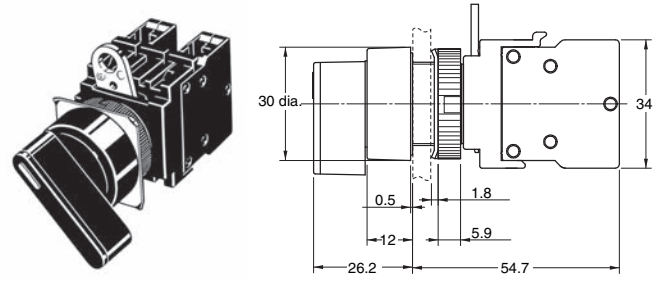
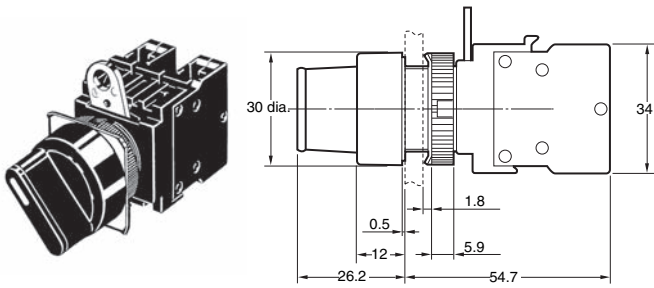

Terminal Arrangement (Bottom View)

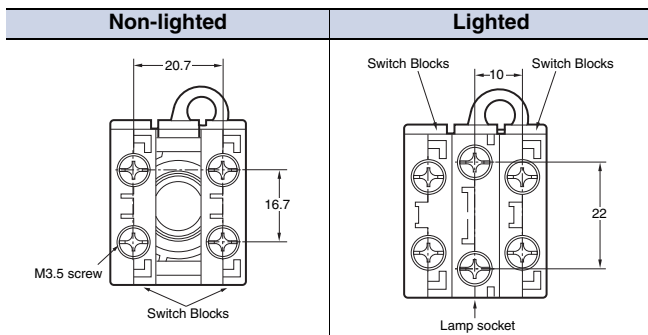

Panel Cutouts

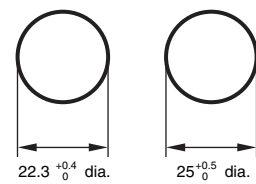

- When applying coating such as paint to the panel, the dimensions should be those after the application of coating.
- Recommended panel thickness: 1 to 5 mm.
- Use an A22Z-R25 Ring when mounting to a panel with 25-mm holes.

Terminal Connection

Type	Connection diagram
Non-lighted	<p>Bottom view</p>
Lighted without Voltage Reduction Unit	<p>Bottom view</p>
Lighted with Voltage Reduction Unit	<p>Bottom view</p>

Note: The above terminal connection diagrams are examples for SPST-NO + SPST-NC.

Accessories

Refer to the relevant information in the corresponding section for the A22.

Safety Precautions

Refer to *Safety Precautions for All Pushbutton Switches/Indicators* and *Safety Precautions for the A22*.

Terms and Conditions Agreement

Read and understand this catalog.

Please read and understand this catalog before purchasing the products. Please consult your OMRON representative if you have any questions or comments.

Warranties.

(a) Exclusive Warranty. Omron's exclusive warranty is that the Products will be free from defects in materials and workmanship for a period of twelve months from the date of sale by Omron (or such other period expressed in writing by Omron). Omron disclaims all other warranties, express or implied.

(b) Limitations. OMRON MAKES NO WARRANTY OR REPRESENTATION, EXPRESS OR IMPLIED, ABOUT NON-INFRINGEMENT, MERCHANTABILITY OR FITNESS FOR A PARTICULAR PURPOSE OF THE PRODUCTS. BUYER ACKNOWLEDGES THAT IT ALONE HAS DETERMINED THAT THE PRODUCTS WILL SUITABLY MEET THE REQUIREMENTS OF THEIR INTENDED USE.

Omron further disclaims all warranties and responsibility of any type for claims or expenses based on infringement by the Products or otherwise of any intellectual property right. (c) Buyer Remedy. Omron's sole obligation hereunder shall be, at Omron's election, to (i) replace (in the form originally shipped with Buyer responsible for labor charges for removal or replacement thereof) the non-complying Product, (ii) repair the non-complying Product, or (iii) repay or credit Buyer an amount equal to the purchase price of the non-complying Product; provided that in no event shall Omron be responsible for warranty, repair, indemnity or any other claims or expenses regarding the Products unless Omron's analysis confirms that the Products were properly handled, stored, installed and maintained and not subject to contamination, abuse, misuse or inappropriate modification. Return of any Products by Buyer must be approved in writing by Omron before shipment. Omron Companies shall not be liable for the suitability or unsuitability or the results from the use of Products in combination with any electrical or electronic components, circuits, system assemblies or any other materials or substances or environments. Any advice, recommendations or information given orally or in writing, are not to be construed as an amendment or addition to the above warranty.

See <http://www.omron.com/global/> or contact your Omron representative for published information.

Limitation on Liability: Etc.

OMRON COMPANIES SHALL NOT BE LIABLE FOR SPECIAL, INDIRECT, INCIDENTAL, OR CONSEQUENTIAL DAMAGES, LOSS OF PROFITS OR PRODUCTION OR COMMERCIAL LOSS IN ANY WAY CONNECTED WITH THE PRODUCTS, WHETHER SUCH CLAIM IS BASED IN CONTRACT, WARRANTY, NEGLIGENCE OR STRICT LIABILITY.

Further, in no event shall liability of Omron Companies exceed the individual price of the Product on which liability is asserted.

Suitability of Use.

Omron Companies shall not be responsible for conformity with any standards, codes or regulations which apply to the combination of the Product in the Buyer's application or use of the Product. At Buyer's request, Omron will provide applicable third party certification documents identifying ratings and limitations of use which apply to the Product. This information by itself is not sufficient for a complete determination of the suitability of the Product in combination with the end product, machine, system, or other application or use. Buyer shall be solely responsible for determining appropriateness of the particular Product with respect to Buyer's application, product or system. Buyer shall take application responsibility in all cases.

NEVER USE THE PRODUCT FOR AN APPLICATION INVOLVING SERIOUS RISK TO LIFE OR PROPERTY OR IN LARGE QUANTITIES WITHOUT ENSURING THAT THE SYSTEM AS A WHOLE HAS BEEN DESIGNED TO ADDRESS THE RISKS, AND THAT THE OMRON PRODUCT(S) IS PROPERLY RATED AND INSTALLED FOR THE INTENDED USE WITHIN THE OVERALL EQUIPMENT OR SYSTEM.

Programmable Products.

Omron Companies shall not be responsible for the user's programming of a programmable Product, or any consequence thereof.

Performance Data.

Data presented in Omron Company websites, catalogs and other materials is provided as a guide for the user in determining suitability and does not constitute a warranty. It may represent the result of Omron's test conditions, and the user must correlate it to actual application requirements. Actual performance is subject to the Omron's Warranty and Limitations of Liability.

Change in Specifications.

Product specifications and accessories may be changed at any time based on improvements and other reasons. It is our practice to change part numbers when published ratings or features are changed, or when significant construction changes are made. However, some specifications of the Product may be changed without any notice. When in doubt, special part numbers may be assigned to fix or establish key specifications for your application. Please consult with your Omron's representative at any time to confirm actual specifications of purchased Product.

Errors and Omissions.

Information presented by Omron Companies has been checked and is believed to be accurate; however, no responsibility is assumed for clerical, typographical or proofreading errors or omissions.