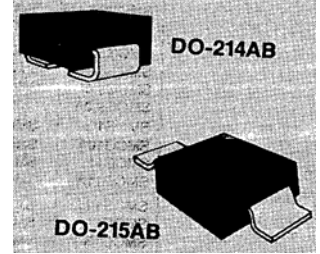


**DESCRIPTION**

These surface mount Transient Voltage Suppressors (TVSs) are electrically equivalent to the 1N6036 thru 1N6072A JEDEC registered axial-leaded devices. They are used for protecting sensitive components requiring low clamping voltage levels and are also available as RoHS Compliant with an e3 suffix. They are rated at high current impulses typically generated by inductive switching transients. Other benefits are achieved with low-profile surface mount J-bend or Gull-wing terminals for stress-relief and lower weight. Its low-flat profile provides easier insertion or automatic handling benefits compared to other MELF style packages. Options for screening similar to JAN, JANTX, JANTXV, and JANS also exist by using MQ, MX, MV or MSP prefixes respectively for part numbers and high reliability screening in accordance with MIL-PRF-19500/507.

**IMPORTANT:** For the most current data, consult MICROSEMI's website: <http://www.microsemi.com>

**APPEARANCE**



**FEATURES**

- Thermally efficient surface mount with J-bends or Gull wing terminations for stress relief (flat handling surface and easier placement)
- Optional 100% **screening for avionics grade** is available by adding MA prefix to part number for added 100% temperature cycle -55°C to +125°C (10X) as well as surge (3X) and 24 hours HTRB with post test  $V_{BR}$  &  $I_D$  (both directions for bidirectional)
- Options for screening in accordance with MIL-PRF-19500/507 for JAN, JANTX, and JANTXV are available by adding MQ, MX, or MV prefixes to part numbers respectively. For example, designate a MXSMCJ6036A for a JANTX screen.
- RoHS Compliant devices available by adding "e3" suffix

**APPLICATIONS / BENEFITS**

- Working Standoff Voltages: 5.5 volts to 185 volts
- Metallurgically bonded
- For high reliability transient voltage suppression in low profile surface mount locations requiring easy placement and strain relief
- Light weight for airborne or satellite applications
- Superior surge quality to protect from ESD and EFT transients per IEC61000-4-2 and -4-4
- Lightning surge protection per IEC61000-4-5 for Class 1 and 2 with source impedance of 42 Ohms as well as Class 3 and 4 selectively at lower voltages ( $V_{WM}$ ) and higher surge current ( $I_{PP}$ ) ratings herein
- Protects sensitive components such as ICs, CMOS, Bipolar, BiCMOS, ECL, DTL,  $T^2L$ , etc.

**MAXIMUM RATINGS**

- Operating temperature: -55°C to +150°C
- Storage temperature: -55°C to +150°C
- 1500 Watts of Peak Pulse Power at 10/1000  $\mu$ s as shown in Figure 3 (see Figure 1 for other  $t_p$  values)
- Thermal resistance,  $R_{\theta JL} = 20^\circ C/W$
- Impulse repetition rate (duty factor): 0.01%
- 5.0 Watt steady-state maximum power at  $T_L = 25^\circ C$
- $t_{clamping}$  (0V to  $V_{(BR)}$  min): less than 5 ns
- Solder temperatures: 260 °C for 10 s (maximum)

**MECHANICAL AND PACKAGING**

- Molded epoxy package meets UL94V-0
- Terminals: Gullwing or C-bend (modified J-bend) leads, tin-lead or RoHS compliant annealed matte-tin plating solderable to MIL-STD-750, method 2026
- Body marked with P/N without SMCJ or SMCG (e.g. 6036A, 6036Ae3, MA6036A, 6039, 6053, 6053e3, etc.)
- No polarity band is shown on these bi-directional types
- Weight: 0.25 grams (approximate)
- Tape & Reel packaging per EIA-481 (2500 units/reel)

**ELECTRICAL CHARACTERISTICS @ 25°C (Test Both Polarities)**

MICROSEMI Part Number	MICROSEMI Part Number	Rated Stand-off Voltage (Note 1)	Breakdown Voltage*			Maximum Clamping Voltage @ $I_{PP}$ (10/1000 $\mu$ s)	Maximum Standby Current @ $V_{WM}$	Maximum Peak Pulse Current (Fig. 2)	Maximum Temperature Coefficient of $V_{(BR)}$
			$V_{WM}$ Volts	$V_{(BR)}$ Volts @	$I_{(BR)}$ mA				
SMCG6036	SMCJ6036	5.5	6.75 - 8.25	10	11.7	1000	128	.061	
SMCG6036A	SMCJ6036A	6.0	7.13 - 7.88	10	11.3	1000	132	.061	
SMCG6037	SMCJ6037	6.5	7.38 - 9.02	10	12.5	500	120	.065	
SMCG6037A	SMCJ6037A	7.0	7.79 - 8.61	10	12.1	500	124	.065	
SMCG6038	SMCJ6038	7.0	8.19 - 10.00	10	13.8	200	109	.068	
SMCG6038A	SMCJ6038A	7.5	8.65 - 9.55	10	13.4	200	112	.068	
SMCG6039	SMCJ6039	8.0	9.0 - 11.0	1	15.0	50	100	.073	
SMCG6039A	SMCJ6039A	8.5	9.5 - 10.5	1	14.5	50	103	.073	
SMCG6040	SMCJ6040	8.5	9.9 - 12.1	1	16.2	10	93	.075	
SMCG6040A	SMCJ6040A	9.0	10.5 - 11.6	1	15.6	10	96	.075	
SMCG6041	SMCJ6041	9.0	10.8 - 13.2	1	17.3	5	87	.078	
SMCG6041A	SMCJ6041A	10.0	11.4 - 12.6	1	16.7	5	90	.078	



**SMCG6036 thru SMCG6072A, e3  
and SMCJ6036 thru SMCJ6072A, e3**

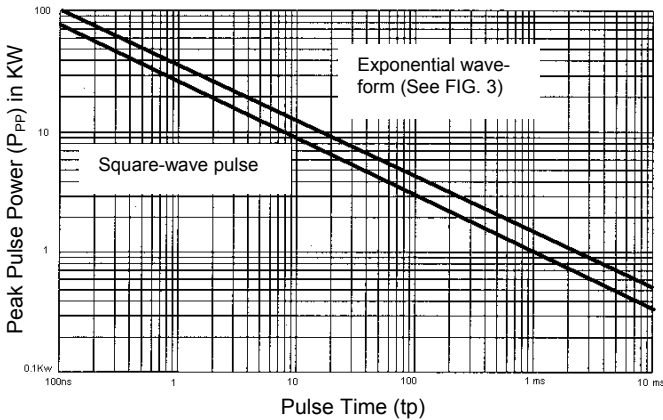
**Bidirectional Transient Voltage Suppressor**

MICROSEMI Part Number  Modified "G" Bend Lead	MICROSEMI Part Number  Modified "J" Bend Lead	Rated Stand-off Voltage (Note 1)  V <sub>WM</sub> Volts	Breakdown Voltage*		Maximum Clamping Voltage @ I <sub>PP</sub> (10/1000 μs)  V <sub>C</sub> Volts	Maximum Standby Current @ V <sub>WM</sub>  I <sub>D</sub> μA	Maximum Peak Pulse Current (Fig. 2)  I <sub>PP</sub> A	Maximum Temperature Coefficient of V <sub>(BR)</sub>  α <sub>V(BR)</sub> %/°C
			V <sub>(BR)</sub> Volts @	I <sub>(BR)</sub> mA				
SMCG6042	SMCJ6042	10.0	11.7 - 14.3	1	19.0	5	79	.081
SMCG6042A	SMCJ6042A	11.0	12.4 - 13.7	1	18.2	5	82	.081
SMCG6043	SMCJ6043	11.0	13.5 - 16.5	1	22.0	5	68	.084
SMCG6043A	SMCJ6043A	12.0	14.3 - 15.8	1	21.2	5	71	.084
SMCG6044	SMCJ6044	12.0	14.4 - 17.5	1	23.5	5	64	.086
SMCG6044A	SMCJ6044A	13.0	15.2 - 16.8	1	22.5	5	67	.068
SMCG6045	SMCJ6045	14.0	16.2 - 19.8	1	26.5	5	56.5	.088
SMCG6045A	SMCJ6045A	15.0	17.1 - 18.9	1	25.2	5	59.5	.088
SMCG6046	SMCJ6046	16.0	18.0 - 22.0	1	29.1	5	51.5	.090
SMCG6046A	SMCJ6046A	17.0	19.0 - 21.0	1	27.7	5	54	.090
SMCG6047	SMCJ6047	17.0	19.8 - 24.2	1	31.9	5	47	.092
SMCG6047A	SMCJ6047A	18.0	20.9 - 23.1	1	30.6	5	49	.092
SMCG6048	SMCJ6048	19.0	21.6 - 26.4	1	34.7	5	43	.094
SMCG6048A	SMCJ6048A	20.0	22.8 - 25.2	1	33.2	5	45	.094
SMCG6049	SMCJ6049	21.0	24.3 - 29.7	1	39.1	5	38.5	.095
SMCG6049A	SMCJ6049A	22.0	25.7 - 28.4	1	37.5	5	40	.096
SMCG6050	SMCJ6050	24.0	27.0 - 33.0	1	43.5	5	34.5	.097
SMCG6050A	SMCJ6050A	25.0	28.5 - 31.5	1	41.4	5	36	.097
SMCG6051	SMCJ6051	26.0	29.7 - 36.3	1	47.7	5	31.5	.098
SMCG6051A	SMCJ6051A	28.0	31.4 - 34.7	1	45.7	5	33	.098
SMCG6052	SMCJ6052	29.0	32.4 - 39.6	1	52.0	5	29	.099
SMCG6052A	SMCJ6052A	30.0	34.2 - 37.8	1	49.9	5	30	.099
SMCG6053	SMCJ6053	31.0	35.1 - 42.9	1	56.4	5	26.5	.100
SMCG6053A	SMCJ6053A	33.0	37.1 - 41.0	1	53.9	5	28	.100
SMCG6054	SMCJ6054	34.0	38.7 - 47.3	1	61.9	5	24	.101
SMCG6054A	SMCJ6054A	36.0	40.9 - 45.2	1	59.3	5	25.3	.101
SMCG6055	SMCJ6055	38.0	42.3 - 51.7	1	67.8	5	22.2	.101
SMCG6055A	SMCJ6055A	40.0	44.7 - 49.4	1	64.8	5	23.2	.101
SMCG6056	SMCJ6056	41.0	45.9 - 56.1	1	73.5	5	20.4	.102
SMCG6056A	SMCJ6056A	43.0	48.5 - 53.6	1	70.1	5	21.4	.102
SMCG6057	SMCJ6057	45.0	50.4 - 61.6	1	80.5	5	18.6	.103
SMCG6057A	SMCJ6057A	47.0	53.2 - 58.8	1	77.0	5	19.5	.103
SMCG6058	SMCJ6058	48.0	55.8 - 68.2	1	89.0	5	16.9	.104
SMCG6058A	SMCJ6058A	53.0	58.9 - 65.1	1	85.0	5	17.7	.104
SMCG6059	SMCJ6059	55.0	61.2 - 74.8	1	98.0	5	15.3	.104
SMCG6059A	SMCJ6059A	58.0	64.6 - 71.4	1	92.0	5	16.3	.104
SMCG6060	SMCJ6060	60.0	67.5 - 82.5	1	108.0	5	13.9	.105
SMCG6060A	SMCJ6060A	64.0	71.3 - 78.8	1	103.0	5	14.6	.105
SMCG6061	SMCJ6061	66.0	73.8 - 90.2	1	118.0	5	12.7	.105
SMCG6061A	SMCJ6061A	70.0	77.9 - 86.1	1	113.0	5	13.3	.105
SMCG6062	SMCJ6062	73.0	81.9 - 100.0	1	131.0	5	11.4	.106
SMCG6062A	SMCJ6062A	75.0	86.5 - 95.5	1	125.0	5	12.0	.106
SMCG6063	SMCJ6063	81.0	90.0 - 110.0	1	144.0	5	10.4	.106
SMCG6063A	SMCJ6063A	82.0	95.0 - 105.0	1	137.0	5	11.0	.106
SMCG6064	SMCJ6064	90.0	99.0 - 121.0	1	158.0	5	9.5	.107
SMCG6064A	SMCJ6064A	94.0	105.0 - 116.0	1	152.0	5	9.9	.107
SMCG6065	SMCJ6065	95.0	108.0 - 132.0	1	176.0	5	8.5	.107
SMCG6065A	SMCJ6065A	100.0	114.0 - 126.0	1	168.0	5	8.9	.107
SMCG6066	SMCJ6066	105.0	117.0 - 143.0	1	191.0	5	7.8	.107
SMCG6066A	SMCJ6066A	110.0	124.0 - 137.0	1	182.0	5	8.2	.107
SMCG6067	SMCJ6067	121.0	135.0 - 165.0	1	223.0	5	6.7	.108
SMCG6067A	SMCJ6067A	128.0	143.0 - 158.0	1	213.0	5	7.0	.108
SMCG6068	SMCJ6068	137.0	153.0 - 187.0	1	258.0	5	5.8	.108
SMCG6068A	SMCJ6068A	145.0	162.0 - 179.0	1	245.0	5	6.1	.108
SMCG6069	SMCJ6069	145.0	162.0 - 198.0	1	274.0	5	5.5	.108
SMCG6069A	SMCJ6069A	150.0	171.0 - 189.0	1	261.0	5	5.7	.108
SMCG6070	SMCJ6070	155.0	171.0 - 210.0	1	292.0	5	5.1	.108
SMCG6070A	SMCJ6070A	160.0	181.0 - 200.0	1	278.0	5	5.4	.108
SMCG6071	SMCJ6071	165.0	180.0 - 220.0	1	308.0	5	4.9	.108
SMCG6071A	SMCJ6071A	170.0	190.0 - 210.0	1	294.0	5	5.1	.108
SMCG6072	SMCJ6072	175.0	198.0 - 242.0	1	344.0	5	4.3	.108
SMCG6072A	SMCJ6072A	185.0	209.0 - 231.0	1	328.0	5	4.6	.108

NOTE 1: A TVS is normally selected according to the rated "Stand Off Voltage" V<sub>WM</sub> which should be equal to or greater than the dc or continuous peak operating voltage level.

\* V<sub>(BR)</sub> is measured after I<sub>(BR)</sub> has been applied for ≤ 300 ms. No suffix is 10% tolerance and suffix A is 5% tolerance for V<sub>(BR)</sub>.

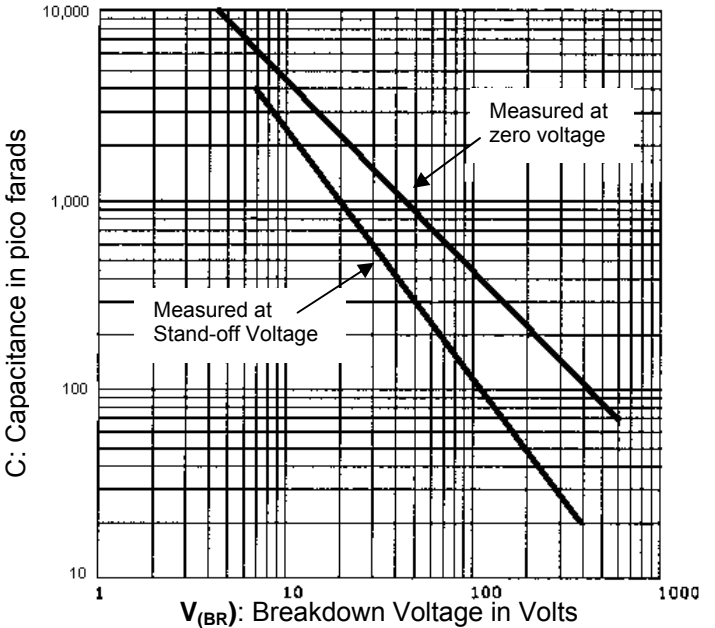
**GRAPHS**



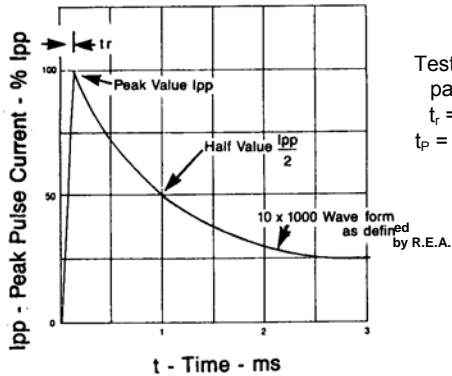
**FIGURE 1**

Non-repetitive peak pulse power rating curve.

**Note:** Peak power defined as peak voltage times peak current.

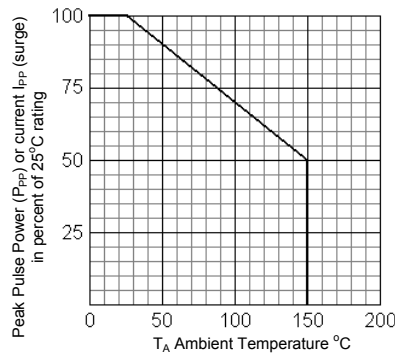


**FIGURE 2** TYPICAL CAPACITANCE vs. BREAKDOWN VOLTAGE

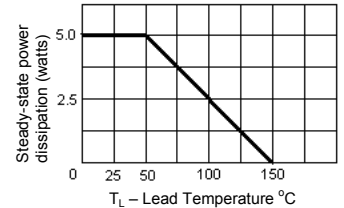


**FIGURE 3**  
PULSE WAVEFORM

Test waveform parameters  
 $t_r = 10\mu\text{sec.}$   
 $t_p = 1000\mu\text{sec.}$

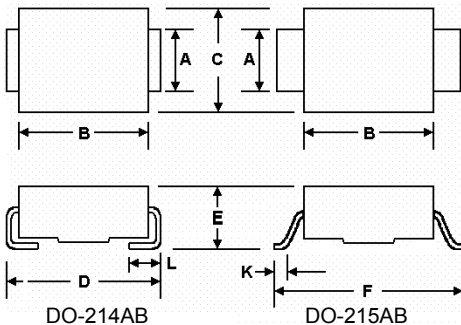


**FIGURE 4** Derating curve



**FIGURE 5**  
Steady-state power derating curve

**PACKAGE DIMENSIONS**



**DIMENSIONS IN INCHES**

	A	B	C	D	E	F	K	L
<b>MIN</b>	.115	.260	.220	.305	.077	.380	.025	.30
<b>MAX</b>	.121	.280	.245	.320	.104	.400	.040	.060

**DIMENSIONS IN MILLIMETERS**

	A	B	C	D	E	F	K	L
<b>MIN</b>	2.92	6.60	5.59	7.75	1.95	9.65	0.635	0.760
<b>MAX</b>	3.07	7.11	6.22	8.13	2.65	10.16	1.016	1.520