

REVISIONS					
REV	ECD	DESCRIPTION	DATE	BY	APPR
01	-	CUSTOMER DRAWING	-	-	-

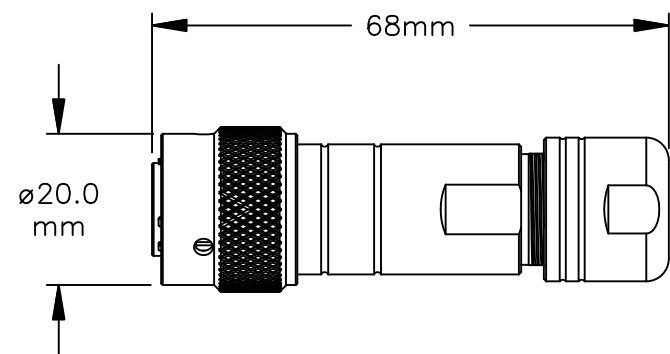

ASSEMBLED VIEW

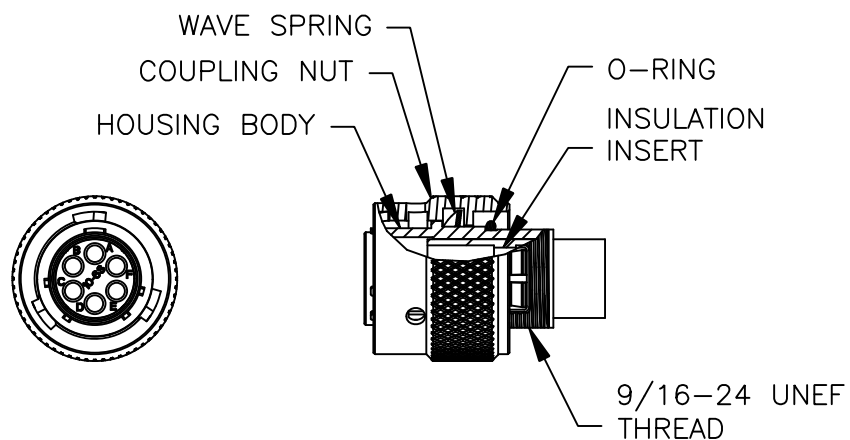
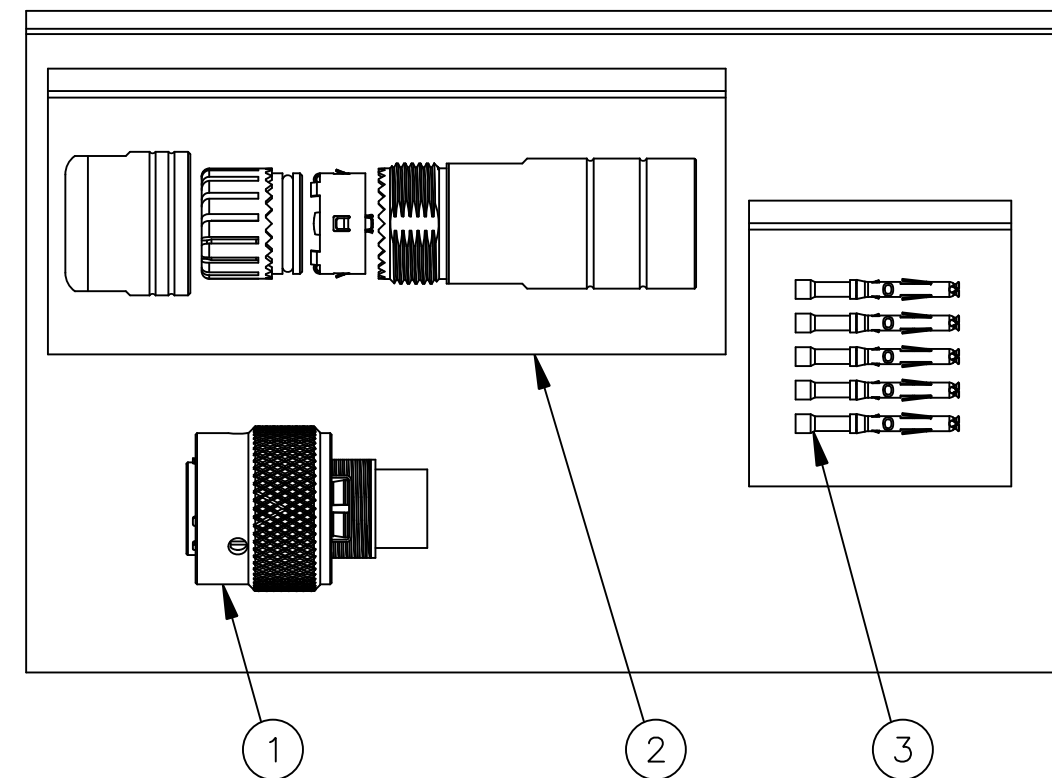

ILLUSTRATION: COMPLETE KIT



NOTES:

- 1) CONTACT BARREL RANGE: 20AWG TO 22AWG
- 2) RECOMMENDED CRIMP TOOLS:
HAND CRIMPER: MFX-3959
PNEUMATIC CRIMPER: MFX-3960
- 3) EXTRACTION TOOL: QXRT20
- 4) MATERIALS:
HOUSING BODY: ZINC DIE CAST, NICKEL PLATED
INSULATION INSERT: PA66, UL94/V-0
CONTACT: BRASS, GOLD FLASH PLATED
SEAL AND O-RING: NBR (NITRILE BUTADIENE RUBBER)
- 5) ELECTRICAL DATA:
a) CURRENT (MAX): 7.5A
b) VOLTAGE (MAX): 150V AC/DC
c) INSULATION RESISTANCE (MIN): 5000M OHMS
d) TEST VOLTAGE (BETWEEN CONTACTS): 1500V

7) TECHNICAL DATA:

- a) TEMPERATURE RANGE: -40°C TO 105°C
- b) PROTECTION: IP67 (MATED CONDITION)
- c) MATING CYCLES: >500
- d) VIBRATION RESISTANCE PER MIL-STD-202 METHOD 204
- e) THERMAL SHOCK PER MIL-STD-202 METHOD 207
- f) 48 HOUR SALT SPRAY PER MIL-STD-202 METHOD 101

8) RoHS COMPLIANT

QUANTITY	PART NUMBER	DESCRIPTION	ITEM
6	MS20W23F	CONTACT, SOCKET, SIZE 20	3
1	RTOL-10CG-S1	CORD GRIP	2
1	RTOW6106SNH	CONNECTOR	1

MATERIALS LIST

UNLESS OTHERWISE SPECIFIED 1) All dimensions are in metric(mm). 2) Tolerances are as follows: 1 PL DEC ±0.30 2 PL DEC ±0.15 3 PL DEC ±0.08 Fractions ±1/64 Angles ±1° 3) Note reference = \triangle X		SIGNATURES DRAWN: MRF CHECKED: ENGINEER: APPROVAL:	DATE 10SEP13	<h1>Amphenol</h1> <p>Sine Systems - www.amphenol-sine.com 44724 Morley Drive Clinton Township, MI 48036</p>	
MATERIAL SPECIFICATIONS:	CUSTOMER:	KIT, ECO-MATE			
PROCESS SPECIFICATIONS:	THIS DRAWING IS SUPPLIED FOR INFORMATION ONLY. DESIGN FEATURES, SPECIFICATIONS AND PERFORMANCE DATA SHOWN HEREON ARE THE PROPERTY OF THE AMPHENOL CORPORATION. NO RIGHTS OF REPRODUCTION ARE IMPLIED. ALL DIMENSIONS ARE SUBJECT TO NORMAL MANUFACTURING VARIATIONS.		SIZE B C-	DWG NO. RTOW6106SNH-K	REVISION 01
NEXT ASSY:	SCALE: NONE	SHEET 1 OF 1			

TITLE:

KIT, ECO-MATE

DWG NO:

REV: 01

SH: 1

DF: 1