

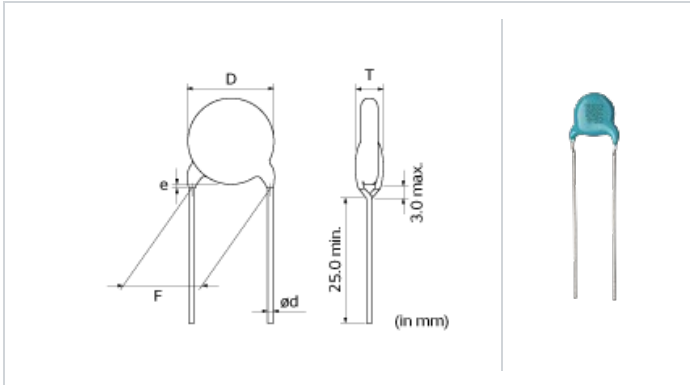

< List of part numbers with package codes >
DEJE3E2332ZA3B

Shape



L size or outer diameter D (mm)	9.0 mm max.
T size	4.0 mm max.
Lead spacing F	7.5 ±1.0mm
Lead diameter d	0.6 ±0.05mm
Paint dripping e	Up to the end of crimp

Notes

Compliant with EA&MS Act

References

Packaging	Specifications	Minimum quantity
B	Packing in bulk	250

Specifications

Capacitance	3300pF +80/-20%
Rated voltage	250Vac(r.m.s.)
Temperature characteristics (complied standard)	E(JIS)
Capacitance change rate	+20/-55%
Temperature range of temperature characteristics	-25 to 85°C
Operating temperature range	-25 to 85°C

Attention

- 1.This datasheet is downloaded from the website of Murata Manufacturing Co., Ltd. Therefore, it's specifications are subject to change or our products in it may be discontinued without advance notice. Please check with our sales representatives or product engineers before ordering.
- 2.This datasheet has only typical specifications because there is no space for detailed specifications. Therefore, please review our product specifications or consult the approval sheet for product specifications before ordering.