

Leaded Common Mode Choke Coils for AC Lines

TLF9UAH302WR42K1

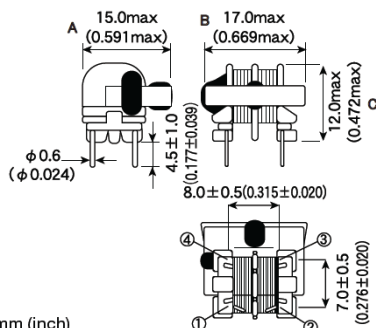

Unit : mm (inch)

■ Features

- Item Summary
3000 uH, 0.42 A, 15.0x17.0x12mm
- Lifecycle Stage
Mass Production
- Standard packaging quantity (minimum)
Bulk 500pcs

■ Products characteristics table

No. of Lines	2
Common Mode Inductance	3000 uH +100/-10%
Case Size (mm)	15.0x17.0
DC Resistance (max)	1.5 Ω
Rated Current (max)	0.42 A
Rated Voltage (max)	AC250 V
Operating Temp. Range	-25 to +105 °C (Including-self-generated heat)
Insulation Resistance (min)	100 MΩ
RoHS2 Compliance (10 subst.)	Yes
REACH Compliance (173 subst.)	Yes
Soldering	Wave

■ External Dimensions

Dimension A	Max 15.0 mm
Dimension B	Max 17.0 mm
Dimension C	Max 12.0 mm

2017.04.30

The data is reference only. Electrical characteristics vary depending on environment or measurement condition.
 TAIYO YUDEN reserves the right to make change to the Date at any time without notice.
 Before making final selection, please check product specification.