

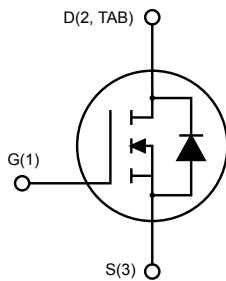

Automotive-grade N-channel 300 V, 0.28 Ω typ., 10 A, MESH OVERLAY™ Power MOSFET in a DPAK package

DPAK

AM01475v1_noZen

Features

Order code	V_{DS}	$R_{DS(on)}$ max.	I_D
STD10NF30	300 V	0.33 Ω	10 A

- AEC-Q101 qualified 
- 100% avalanche tested
- Low capacitance and gate charge
- 175 °C maximum junction temperature

Applications

- Switching applications

Description

This fully clamped MOSFET is produced using ST's latest advanced Mesh overlay process, which is based on an innovative strip layout. The inherent benefits of the new technology coupled with the extra clamping capabilities make this product particularly suitable for the harshest operation conditions, such as those encountered in the automotive environment. The device is also well-suited for other applications where extra ruggedness is required.

Product status link

[STD10NF30](#)

Product summary

Order code	STD10NF30
Marking	10NF30
Package	DPAK
Packing	Tape and reel

1 Electrical ratings

Table 1. Absolute maximum ratings

Symbol	Parameter	Value	Unit
V_{DS}	Drain-source voltage	300	V
V_{GS}	Gate-source voltage	± 20	V
I_D	Drain current (continuous) at $T_C = 25\text{ }^\circ\text{C}$	10	A
	Drain current (continuous) at $T_C = 100\text{ }^\circ\text{C}$	6.3	A
$I_{DM}^{(1)}$	Drain current (pulsed)	40	A
P_{TOT}	Total dissipation at $T_C = 25\text{ }^\circ\text{C}$	103	W
$dv/dt^{(2)}$	Peak diode recovery voltage slope	12	V/ns
T_{stg}	Storage temperature range	-55 to 175	$^\circ\text{C}$
T_j	Operating junction temperature range		

1. Pulse width limited by safe operating area.
2. $I_{SD} \leq 10\text{ A}$, $di/dt \leq 200\text{ A}/\mu\text{s}$, $V_{DD} = 80\% V_{(BR)DSS}$

Table 2. Thermal data

Symbol	Parameter	Value	Unit
$R_{thj-case}$	Thermal resistance junction-case	1.45	$^\circ\text{C}/\text{W}$
$R_{thj-pcb}^{(1)}$	Thermal resistance junction-pcb	50	$^\circ\text{C}/\text{W}$

1. When mounted on 1 inch² FR-4, 2 Oz copper board.

Table 3. Avalanche characteristics

Symbol	Parameter	Value	Unit
I_{AR}	Avalanche current, repetitive or non-repetitive (pulse width limited by T_{Jmax})	6	A
E_{AS}	Single pulse avalanche energy (starting $T_j = 25\text{ }^\circ\text{C}$, $I_D = I_{AR}$, $V_{DD} = 50\text{ V}$)	175	mJ

2 Electrical characteristics

$T_{CASE} = 25\text{ °C}$ unless otherwise specified.

Table 4. On/off states

Symbol	Parameter	Test conditions	Min.	Typ.	Max.	Unit
$V_{(BR)DSS}$	Drain-source breakdown voltage	$V_{GS} = 0\text{ V}$, $I_D = 1\text{ mA}$	300			V
I_{DSS}	Zero gate voltage drain current	$V_{GS} = 0\text{ V}$, $V_{DS} = 300\text{ V}$			1	μA
		$V_{GS} = 0\text{ V}$, $V_{DS} = 300\text{ V}$, $T_C = 125\text{ °C}^{(1)}$			10	μA
I_{GSS}	Gate body leakage current	$V_{DS} = 0\text{ V}$, $V_{GS} = \pm 20\text{ V}$			± 100	nA
$V_{GS(th)}$	Gate threshold voltage	$V_{DD} = V_{GS}$, $I_D = 250\text{ }\mu\text{A}$	2	3	4	V
$R_{DS(on)}$	Static drain-source on-resistance	$V_{GS} = 10\text{ V}$, $I_D = 5\text{ A}$		0.28	0.33	Ω

1. Defined by design, not subject to production test.

Table 5. Dynamic

Symbol	Parameter	Test conditions	Min.	Typ.	Max.	Unit
C_{ISS}	Input capacitance	$V_{DS} = 25\text{ V}$, $f = 1\text{ MHz}$, $V_{GS} = 0\text{ V}$	-	780	-	pF
C_{OSS}	Output capacitance		-	110	-	pF
C_{RSS}	Reverse transfer capacitance		-	15	-	pF
Q_g	Total gate charge	$V_{DD} = 240\text{ V}$, $I_D = 10\text{ A}$	-	23	-	nC
Q_{gs}	Gate-source charge	$V_{GS} = 0\text{ to }10\text{ V}$	-	3.5	-	nC
Q_{gd}	Gate-drain charge	(see Figure 13. Test circuit for gate charge behavior)	-	11.3	-	nC

Table 6. Switching times

Symbol	Parameter	Test conditions	Min.	Typ.	Max.	Unit
$t_{d(on)}$	Turn-on delay time	$V_{DD} = 150\text{ V}$, $I_D = 5\text{ A}$, $R_G = 4.7\text{ }\Omega$, $V_{GS} = 10\text{ V}$ (see Figure 12. Test circuit for resistive load switching times and Figure 17. Switching time waveform)	-	13.5	-	ns
t_r	Rise time		-	9.5	-	ns
$t_{d(off)}$	Turn-off delay time		-	32	-	ns
t_f	Fall time		-	9.5	-	ns

Table 7. Source-drain diode

Symbol	Parameter	Test conditions	Min.	Typ.	Max.	Unit
I_{SD}	Source-drain current		-		10	A
$I_{SDM}^{(1)}$	Source-drain current (pulsed)		-		40	A
$V_{SD}^{(2)}$	Forward on voltage	$I_{SD} = 10\text{ A}$, $V_{GS} = 0\text{ V}$	-		1.5	V

Symbol	Parameter	Test conditions	Min.	Typ.	Max.	Unit
t_{rr}	Reverse recovery time	$I_{SD} = 10\text{ A}$, $di/dt = 100\text{ A}/\mu\text{s}$, $V_{DD} = 60\text{ V}$ (see Figure 14. Test circuit for inductive load switching and diode recovery times)	-	145		ns
Q_{rr}	Reverse recovery charge		-	0.76		μC
I_{RRM}	Reverse recovery current		-	10.3		A
t_{rr}	Reverse recovery time	$I_{SD} = 10\text{ A}$, $di/dt = 100\text{ A}/\mu\text{s}$, $V_{DD} = 60\text{ V}$, $T_J = 150\text{ }^\circ\text{C}$ (see Figure 14. Test circuit for inductive load switching and diode recovery times)	-	174		ns
Q_{rr}	Reverse recovery charge		-	1.08		μC
I_{RRM}	Reverse recovery current		-	12.5		A

1. Pulse width limited by safe operating area
2. Pulsed: pulse duration = 300 μs , duty cycle 1.5%

2.1 Electrical characteristics (curves)

Figure 1. Safe operating area

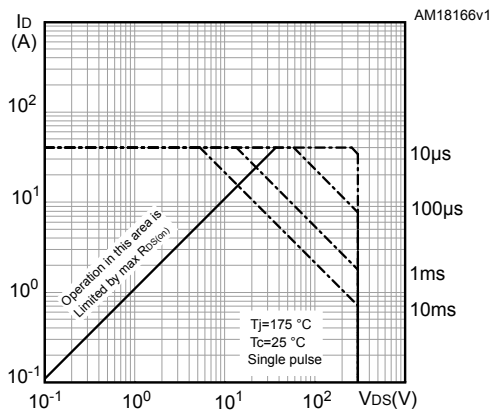

Figure 2. Thermal impedance

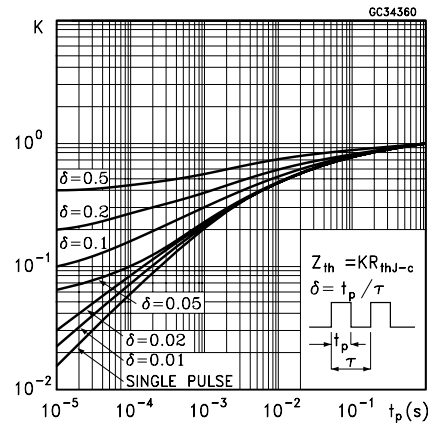

Figure 3. Output characteristics

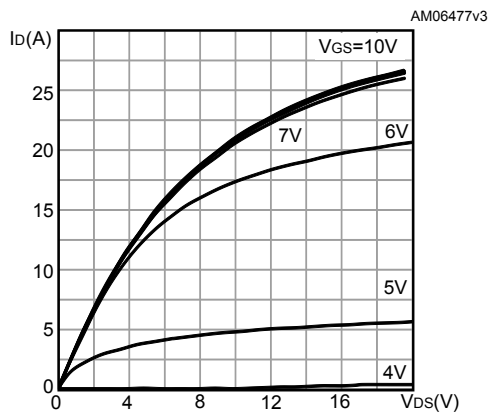

Figure 4. Transfer characteristics

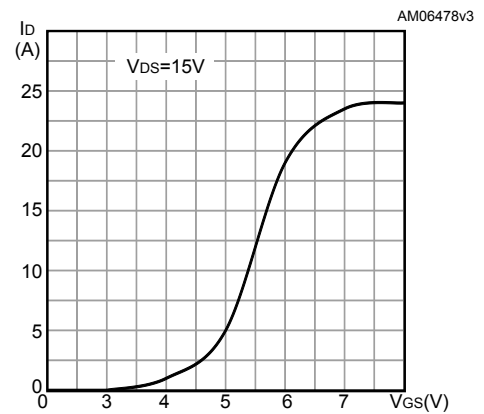

Figure 5. Static drain-source on-resistance

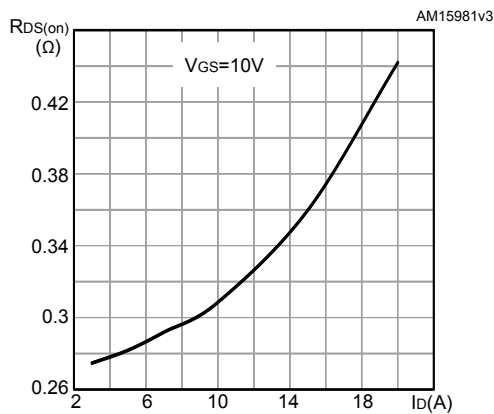

Figure 6. Gate charge vs gate-source voltage

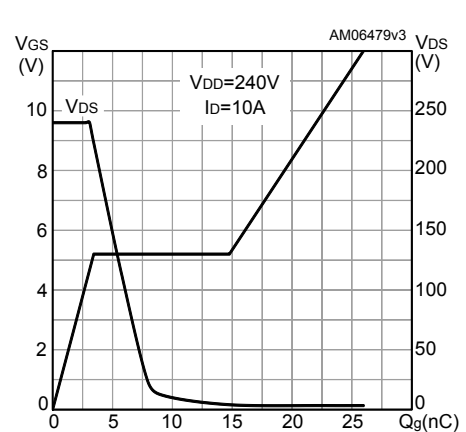

Figure 7. Capacitance variations

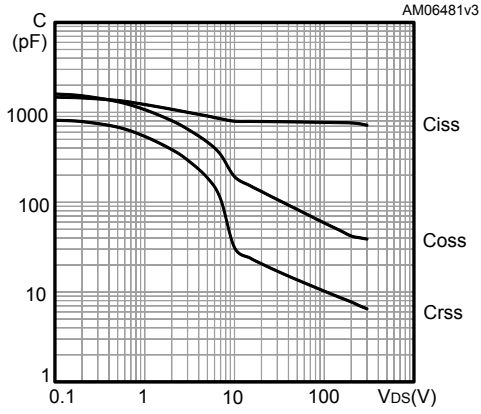

Figure 8. Normalized gate threshold voltage vs temperature

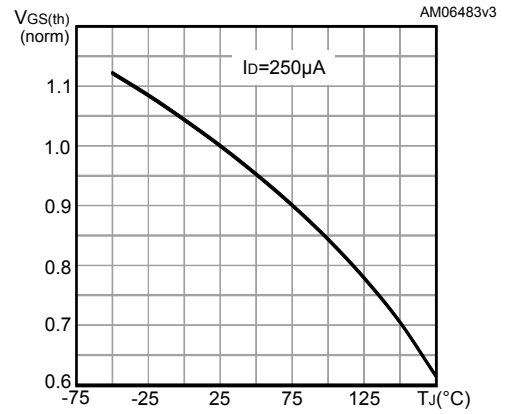

Figure 9. Normalized on-resistance vs temperature

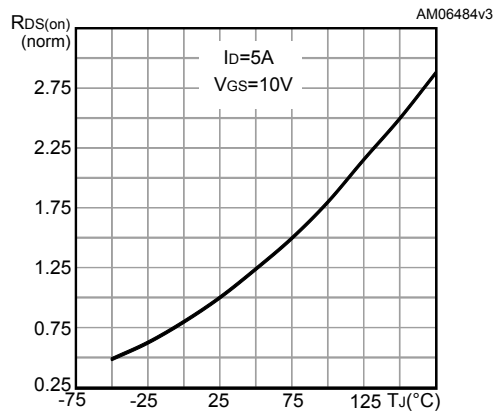

Figure 10. Normalized V_{(BR)DSS} vs temperature

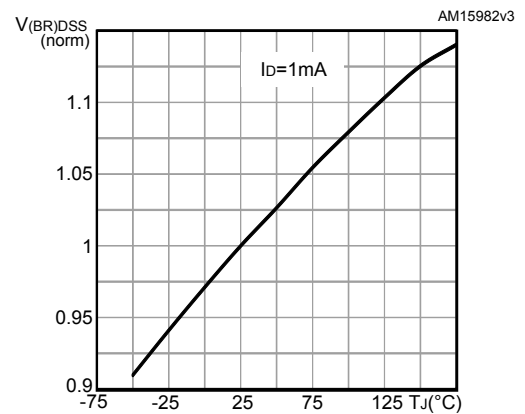
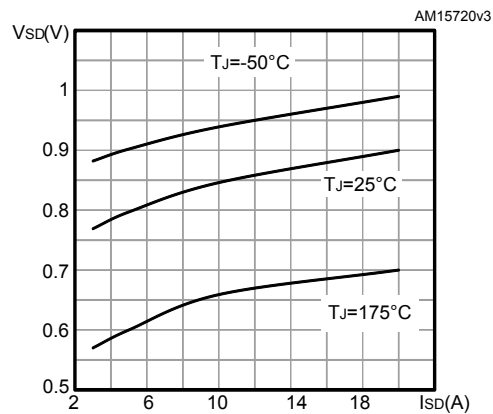

Figure 11. Source-drain diode forward characteristics



3 Test circuits

Figure 12. Test circuit for resistive load switching times

AM01468v1

Figure 13. Test circuit for gate charge behavior

AM01469v1

Figure 14. Test circuit for inductive load switching and diode recovery times

AM01470v1

Figure 15. Unclamped inductive load test circuit

AM01471v1

Figure 16. Unclamped inductive waveform



AM01472v1

Figure 17. Switching time waveform

AM01473v1

4 Package information

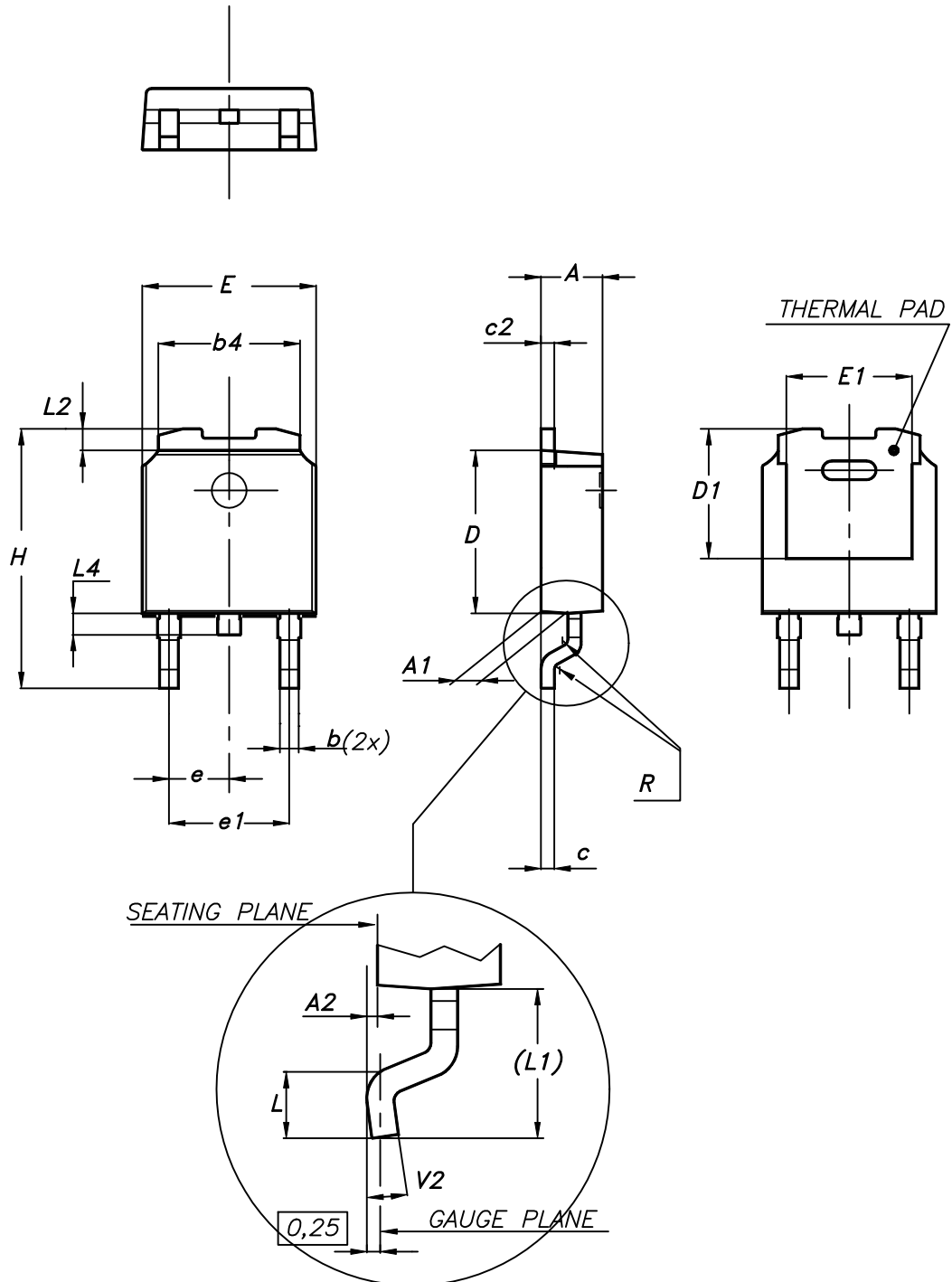
In order to meet environmental requirements, ST offers these devices in different grades of ECOPACK® packages, depending on their level of environmental compliance. ECOPACK® specifications, grade definitions and product status are available at: www.st.com. ECOPACK® is an ST trademark.

4.1 DPAK (TO-252) type A2 package information
Figure 18. DPAK (TO-252) type A2 package outline

0068772_type-A2_rev25

Table 8. DPAK (TO-252) type A2 mechanical data

Dim.	mm		
	Min.	Typ.	Max.
A	2.20		2.40
A1	0.90		1.10
A2	0.03		0.23
b	0.64		0.90
b4	5.20		5.40
c	0.45		0.60
c2	0.48		0.60
D	6.00		6.20
D1	4.95	5.10	5.25
E	6.40		6.60
E1	5.10	5.20	5.30
e	2.159	2.286	2.413
e1	4.445	4.572	4.699
H	9.35		10.10
L	1.00		1.50
L1	2.60	2.80	3.00
L2	0.65	0.80	0.95
L4	0.60		1.00
R		0.20	
V2	0°		8°

Figure 19. DPAK (TO-252) recommended footprint (dimensions are in mm)

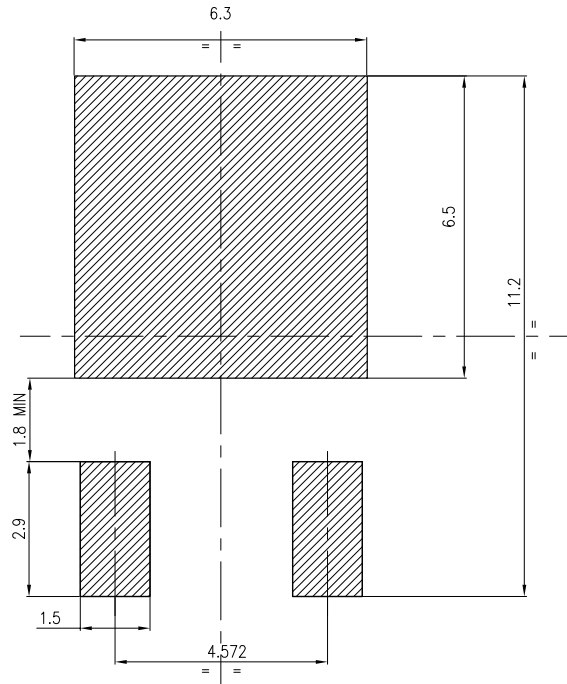

FP_0068772_25

4.2 DPAK (TO-252) packing information

Figure 20. DPAK (TO-252) tape outline

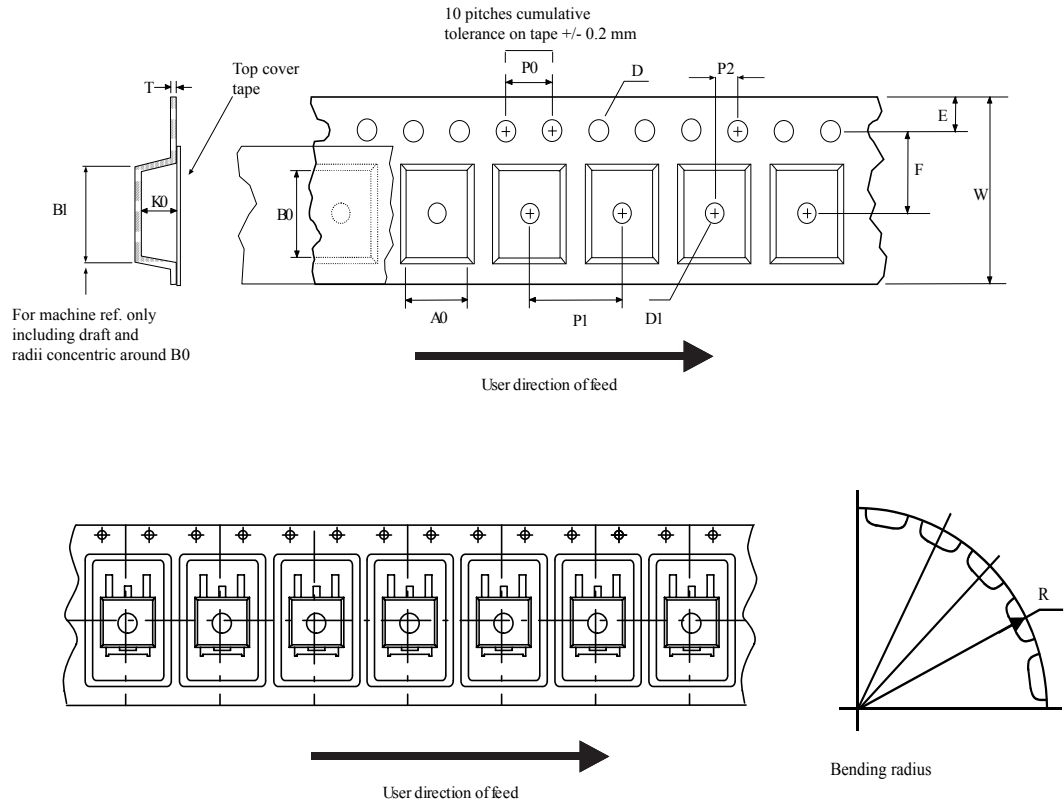

AM08852v1

Figure 21. DPAK (TO-252) reel outline

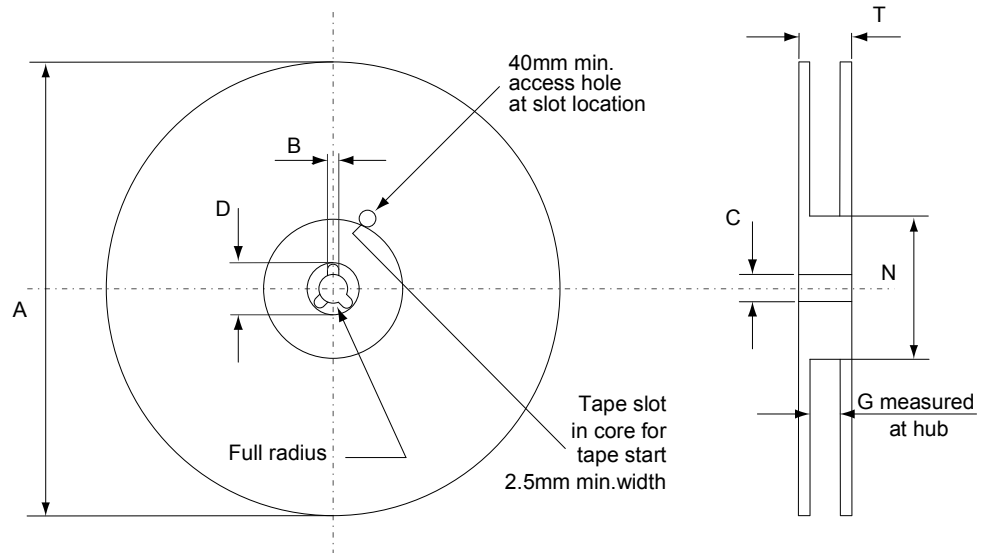

AM06038v1

Table 9. DPAK (TO-252) tape and reel mechanical data

Tape			Reel		
Dim.	mm		Dim.	mm	
	Min.	Max.		Min.	Max.
A0	6.8	7	A		330
B0	10.4	10.6	B	1.5	
B1		12.1	C	12.8	13.2
D	1.5	1.6	D	20.2	
D1	1.5		G	16.4	18.4
E	1.65	1.85	N	50	
F	7.4	7.6	T		22.4
K0	2.55	2.75			
P0	3.9	4.1	Base qty.		2500
P1	7.9	8.1	Bulk qty.		2500
P2	1.9	2.1			
R	40				
T	0.25	0.35			
W	15.7	16.3			

Revision history

Table 10. Document revision history

Date	Version	Changes
27-Mar-2014	1	Initial release.
02-Jul-2018	2	Removed maturity status indication from cover page. The document status is production data. Updated Section 4.1 DPAK (TO-252) type A2 package information . Minor text changes.

Contents

1	Electrical ratings	2
2	Electrical characteristics	3
2.1	Electrical characteristics (curves)	5
3	Test circuits	7
4	Package information	8
4.1	DPAK (TO-252) type A2 package information	8
4.2	DPAK (TO-252) packing information	11
	Revision history	14

IMPORTANT NOTICE – PLEASE READ CAREFULLY

STMicroelectronics NV and its subsidiaries (“ST”) reserve the right to make changes, corrections, enhancements, modifications, and improvements to ST products and/or to this document at any time without notice. Purchasers should obtain the latest relevant information on ST products before placing orders. ST products are sold pursuant to ST’s terms and conditions of sale in place at the time of order acknowledgement.

Purchasers are solely responsible for the choice, selection, and use of ST products and ST assumes no liability for application assistance or the design of Purchasers’ products.

No license, express or implied, to any intellectual property right is granted by ST herein.

Resale of ST products with provisions different from the information set forth herein shall void any warranty granted by ST for such product.

ST and the ST logo are trademarks of ST. All other product or service names are the property of their respective owners.

Information in this document supersedes and replaces information previously supplied in any prior versions of this document.

© 2018 STMicroelectronics – All rights reserved